



ASME B30.27-2014
(Revision of ASME B30.27-2009)

Material Placement Systems

**Safety Standard for Cableways,
Cranes, Derricks, Hoists, Hooks,
Jacks, and Slings**

AN AMERICAN NATIONAL STANDARD



**The American Society of
Mechanical Engineers**

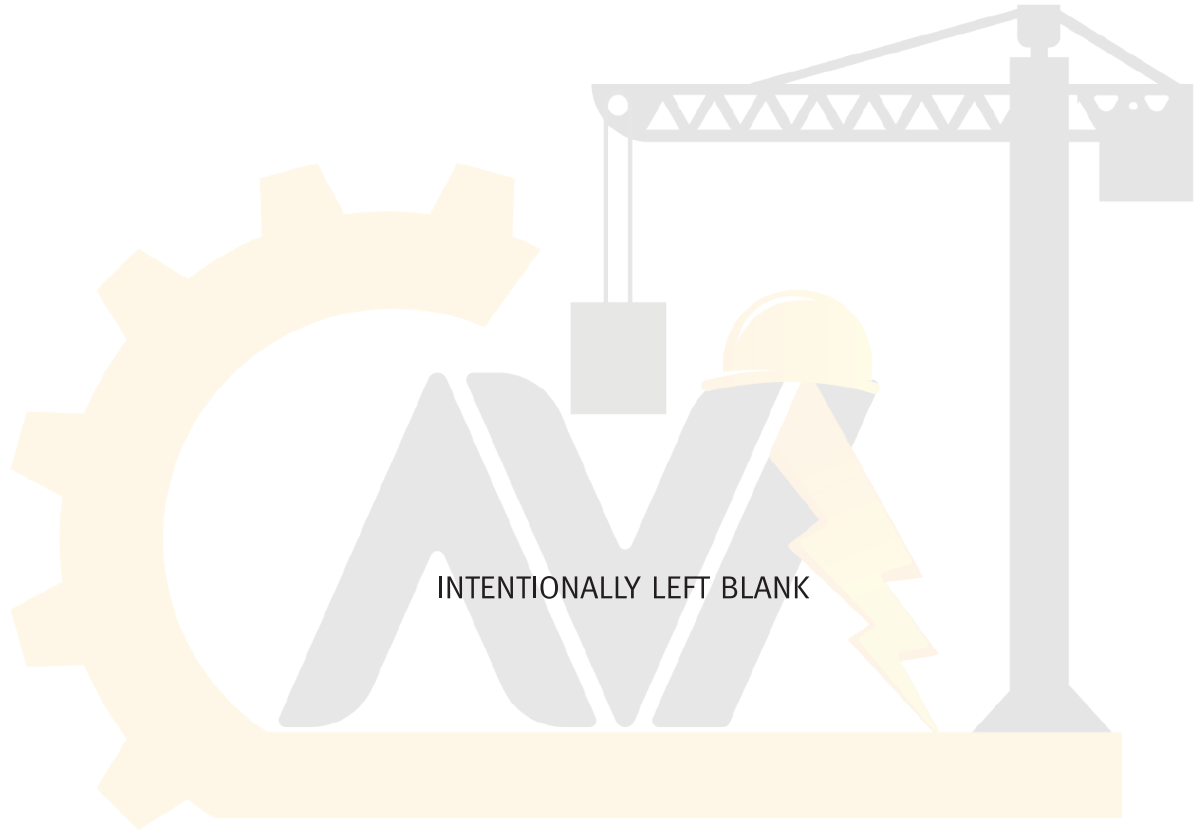

INTENTIONALLY LEFT BLANK

آریا ایمن آوات



ASME B30.27-2014
(Revision of ASME B30.27-2009)

Material Placement Systems

**Safety Standard for Cableways,
Cranes, Derricks, Hoists, Hooks,
Jacks, and Slings**

آریا ایمن آوات

AN AMERICAN NATIONAL STANDARD



**The American Society of
Mechanical Engineers**

Two Park Avenue • New York, NY • 10016 USA



Date of Issuance: March 26, 2014

The next edition of this Standard is scheduled for publication in 2019.

ASME issues written replies to inquiries concerning interpretations of technical aspects of this Standard. Interpretations are published on the ASME Web site under the Committee Pages at <http://cstools.asme.org/> as they are issued.

Errata to codes and standards may be posted on the ASME Web site under the Committee Pages to provide corrections to incorrectly published items, or to correct typographical or grammatical errors in codes and standards. Such errata shall be used on the date posted.

The Committee Pages can be found at <http://cstools.asme.org/>. There is an option available to automatically receive an e-mail notification when errata are posted to a particular code or standard. This option can be found on the appropriate Committee Page after selecting “Errata” in the “Publication Information” section.

ASME is the registered trademark of The American Society of Mechanical Engineers.

This code or standard was developed under procedures accredited as meeting the criteria for American National Standards. The Standards Committee that approved the code or standard was balanced to assure that individuals from competent and concerned interests have had an opportunity to participate. The proposed code or standard was made available for public review and comment that provides an opportunity for additional public input from industry, academia, regulatory agencies, and the public-at-large.

ASME does not “approve,” “rate,” or “endorse” any item, construction, proprietary device, or activity.

ASME does not take any position with respect to the validity of any patent rights asserted in connection with any items mentioned in this document, and does not undertake to insure anyone utilizing a standard against liability for infringement of any applicable letters patent, nor assumes any such liability. Users of a code or standard are expressly advised that determination of the validity of any such patent rights, and the risk of infringement of such rights, is entirely their own responsibility.

Participation by federal agency representative(s) or person(s) affiliated with industry is not to be interpreted as government or industry endorsement of this code or standard.

ASME accepts responsibility for only those interpretations of this document issued in accordance with the established ASME procedures and policies, which precludes the issuance of interpretations by individuals.

No part of this document may be reproduced in any form,
in an electronic retrieval system or otherwise,
without the prior written permission of the publisher.

The American Society of Mechanical Engineers
Two Park Avenue, New York, NY 10016-5990

Copyright © 2014 by
THE AMERICAN SOCIETY OF MECHANICAL ENGINEERS
All rights reserved
Printed in U.S.A.



CONTENTS

Foreword	v	
Committee Roster	vii	
B30 Standard Introduction	ix	
Summary of Changes	xii	
Chapter 27-0	Scope, Definitions, References, and Personnel Competence	1
Section 27-0.1	Scope	1
Section 27-0.2	Definitions	1
Section 27-0.3	Reference to Other Codes and Standards	3
Section 27-0.4	Personnel Competence	4
Chapter 27-1	Construction and Installation	5
Section 27-1.1	Markings	5
Section 27-1.2	Mobile Material Placing Boom Construction	6
Section 27-1.3	Work Platforms, Access Walkways, and Gangways	6
Section 27-1.4	Electrical Installations	6
Section 27-1.5	Ergonomics	6
Section 27-1.6	Outriggers	7
Section 27-1.7	Controls and Indicators	7
Section 27-1.8	Guards	7
Section 27-1.9	Mobile and Stationary Placing Booms	7
Section 27-1.10	Delivery Systems	8
Section 27-1.11	Loss of Power	8
Section 27-1.12	Remote Starting	8
Section 27-1.13	Manuals	8
Section 27-1.14	Translation of Non-English Documentation Into English	9
Section 27-1.15	Fuel and Exhaust Systems	9
Section 27-1.16	Hoppers	9
Section 27-1.17	Pump Pressure Release	9
Chapter 27-2	Inspection, Testing, and Maintenance	11
Section 27-2.1	Inspection	11
Section 27-2.2	Testing	12
Section 27-2.3	Maintenance	13
Chapter 27-3	Operation	14
Section 27-3.1	Qualifications for and Conduct of Operators and Operating Practices	14
Section 27-3.2	Material Placement System Lockout/Tagout	21
Section 27-3.3	Signals	21
Figures		
27-0.1-1	Material Placement System: Truck-Mounted Concrete Pump With Integrated Placing Boom	2
27-0.1-2	Material Placement System: Separate Placing Boom	2
27-0.1-3	Material Placement System: Truck-Mounted Telescopic Conveyor System	2
27-0.1-4	Material Placement System: Examples of Delivery System Components	3
27-1.7.5-1	Standardized Joystick Movement	8
27-1.16-1	Grates and Hoppers	10
27-3.1.5-1	Area of Extended Outriggers	20



1.6.1-1	Danger Zone for Material Placement Systems and Delivery System	
	Operating Near Electrical Transmission Lines	22
27-3.3.2-1	Material Placement System Hand Signals	23
Table		
27-3.1.6.3-1	Minimum Required Clearances	23

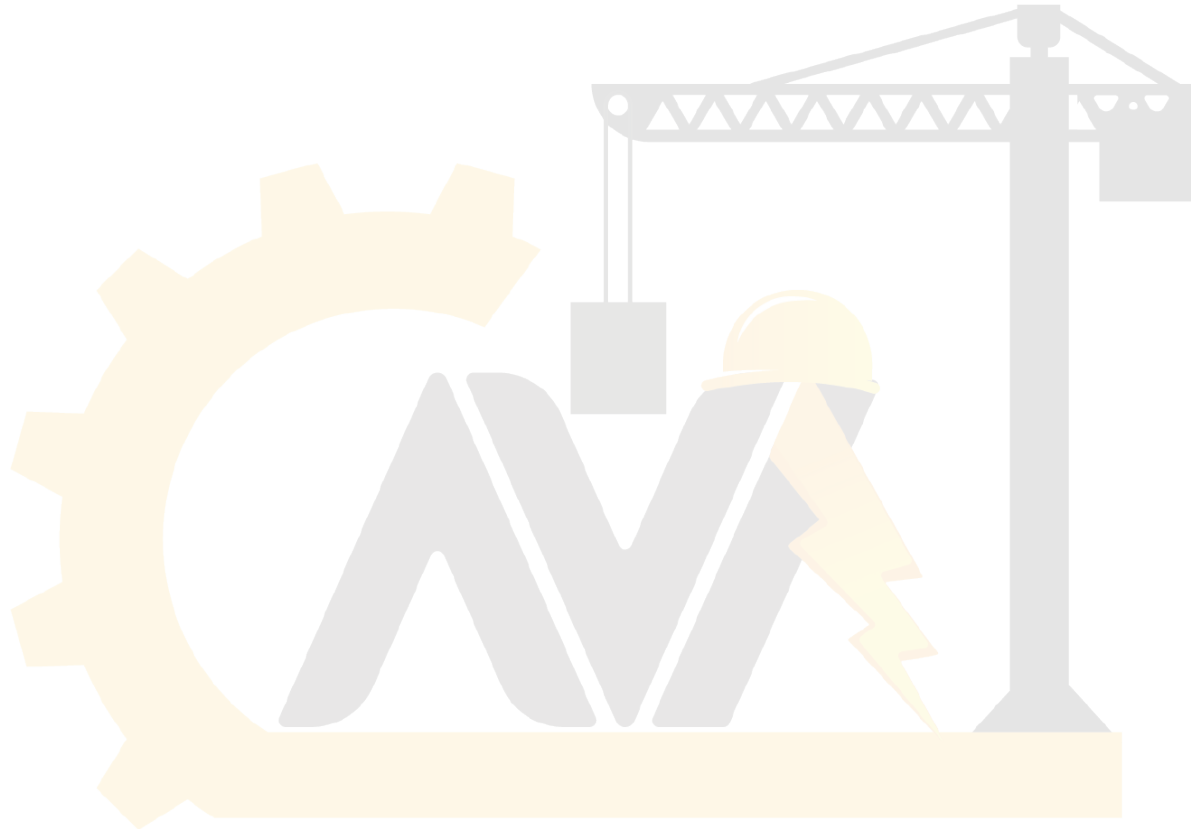

آریا ایمن آوات



FOREWORD

This American National Standard, Safety Standard for Cableways, Cranes, Derricks, Hoists, Hooks, Jacks, and Slings, has been developed under the procedures accredited by the American National Standards Institute (ANSI, formerly the United States of America Standards Institute). This Standard had its beginning in December 1916 when an eight-page Code of Safety Standards for Cranes, prepared by an American Society of Mechanical Engineers (ASME) Committee on the Protection of Industrial Workers, was presented at the annual meeting of ASME.

Meetings and discussions regarding safety on cranes, derricks, and hoists were held from 1920 to 1925, involving the ASME Safety Code Correlating Committee, the Association of Iron and Steel Electrical Engineers, the American Museum of Safety, the American Engineering Standards Committee (later changed to American Standards Association and subsequently to the USA Standards Institute), Department of Labor — State of New Jersey, Department of Labor and Industry — State of Pennsylvania, and the Locomotive Crane Manufacturers Association. On June 11, 1925, the American Engineering Standards Committee approved the ASME Safety Code Correlating Committee's recommendation and authorized the project with the U.S. Department of the Navy, Bureau of Yards and Docks, and ASME as sponsors.

In March 1926, invitations were issued to 50 organizations to appoint representatives to a Sectional Committee. The call for organization of this Sectional Committee was sent out October 2, 1926, and the committee organized November 4, 1926, with 57 members representing 29 national organizations. The Safety Code for Cranes, Derricks, and Hoists, ASA B30.2-1943, was created from the eight-page document referred to in the first paragraph. This document was reaffirmed in 1952 and widely accepted as a safety standard.

Due to changes in design, advancement in techniques, and general interest of labor and industry in safety, the Sectional Committee, under the joint sponsorship of ASME and the Naval Facilities Engineering Command, U.S. Department of the Navy, was reorganized as an American National Standards Committee on January 31, 1962, with 39 members representing 27 national organizations.

The format of the previous code was changed so that separate Volumes (each complete as to construction and installation; inspection, testing, and maintenance; and operation) will cover the different types of equipment included in the scope of B30.

In 1982, the Committee was reorganized as an Accredited Organization Committee, operating under procedures developed by ASME and accredited by ANSI.

This Standard presents a coordinated set of rules that may serve as a guide to government and other regulatory bodies and municipal authorities responsible for the guarding and inspection of the equipment falling within its scope. The suggestions leading to accident prevention are given both as mandatory and advisory provisions; compliance with both types may be required by employers of their employees.

In case of practical difficulties, new developments, or unnecessary hardship, the administrative or regulatory authority may grant variances from the literal requirements or permit the use of other devices or methods, but only when it is clearly evident that an equivalent degree of protection is thereby secured. To secure uniform application and interpretation of this Standard, administrative or regulatory authorities are urged to consult the B30 Committee, in accordance with the format described in Section IX of the B30 Standard Introduction, before rendering decisions on disputed points.

Safety codes and standards are intended to enhance public safety. Revisions result from committee consideration of factors such as technological advances, new data, and changing environmental and industry needs. Revisions do not imply that previous editions were inadequate.



The 2009 edition consolidated the requirements of two standards, CPMA 27-2000 and B30.27-2005, into the B30.27 Volume. This 2014 edition of B30.27 incorporates many global B30 changes, including the addition of para. 27-3.1.3, requirements for translation of documents, and several other changes.

This Volume of the Standard, which was approved by the B30 Standards Committee and by ASME, was approved by ANSI and designated as an American National Standard on February 19, 2014.

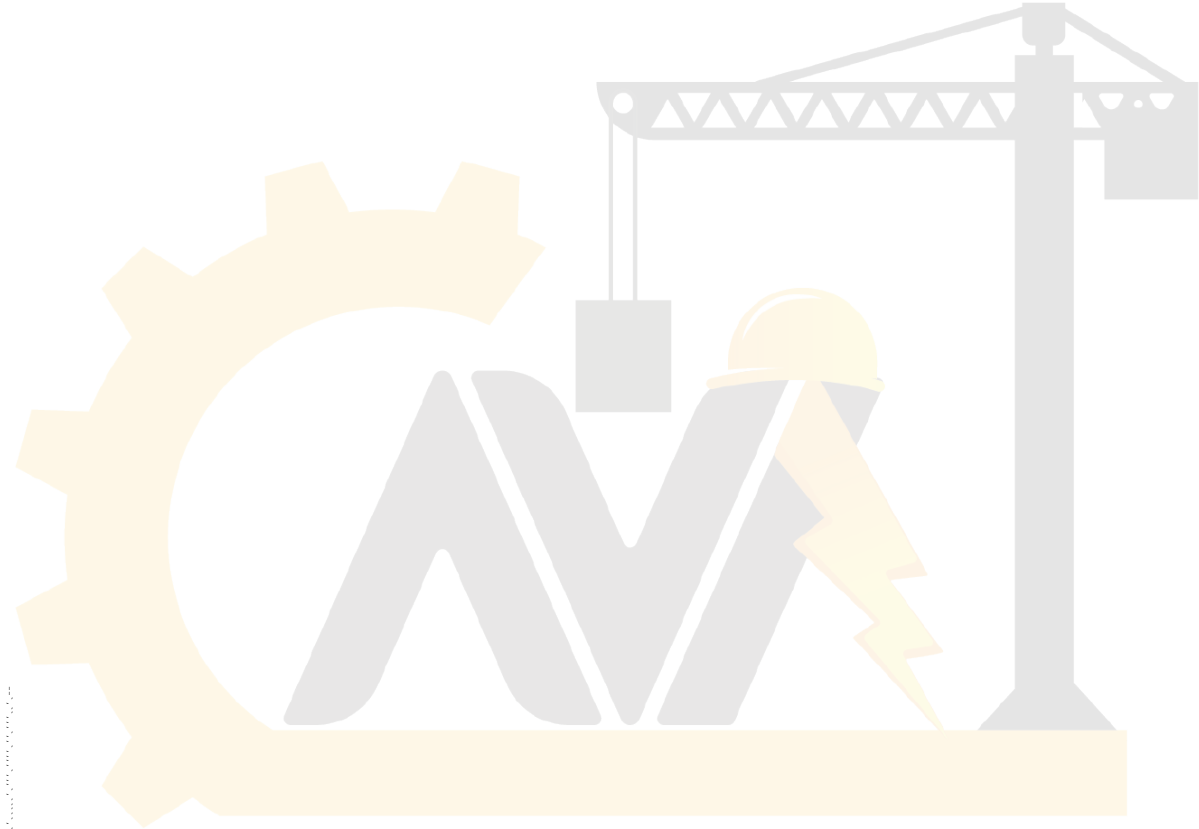

آریا ایمن آوات



ASME B30 COMMITTEE

Safety Standard for Cableways, Cranes, Derricks, Hoists, Hooks, Jacks, and Slings

(The following is the roster of the Committee at the time of approval of this Standard.)

STANDARDS COMMITTEE OFFICERS

L. D. Means, *Chair*
R. M. Parnell, *Vice Chair*
K. M. Hyam, *Secretary*

STANDARDS COMMITTEE PERSONNEL

- N. E. Andrew**, ThyssenKrupp Steel USA, LLC
C. M. Robison, *Alternate*, UT-Battelle/Oak Ridge National Laboratory
T. L. Blanton, NACB Group, Inc.
P. A. Boeckman, The Crosby Group, Inc.
C. E. Lucas, *Alternate*, The Crosby Group, Inc.
R. J. Bolen, Consultant
C. E. Cotton, *Alternate*, Navy Crane Center
M. E. Brunet, Manitowoc Cranes/The Manitowoc Crane Group
A. L. Calta, *Alternate*, Manitowoc Cranes/The Manitowoc Crane Group
B. D. Closson, Craft Forensic Services
B. A. Pickett, *Alternate*, Forensic Engineering and Applied Science Institute
R. M. Cutshall, Savannah River Nuclear Solutions
J. A. Danielson, Boeing Co.
P. W. Boyd, *Alternate*, Boeing Co.
L. D. DeMark, Sr., Equipment Training Solutions, LLC
D. F. Jordan, *Alternate*, BP America
D. W. Eckstine, Eckstine and Associates
R. J. Edwards, NBIS
A. J. Egging, National Oilwell Varco
C. W. Ireland, *Alternate*, National Oilwell Varco
E. D. Fidler, The Manitowoc Co.
G. D. Miller, *Alternate*, Manitowoc Cranes
J. A. Gilbert, Associated Wire Rope Fabricators
J. L. Gordon, Acco Chain and Lifting Products
N. C. Hargreaves, Hargreaves Consulting, LLC
C. E. Imerman, *Alternate*, Link-Belt Construction Equipment Co.
W. C. Dickinson, Jr., *Alternate*, Crane Industry Services, LLC
G. B. Hetherston, E. I. DuPont
J. B. Greenwood, *Alternate*, Navy Crane Center
K. M. Hyam, The American Society of Mechanical Engineers
D. C. Jackson, Tulsa Winch Group
S. D. Wood, *Alternate*, Link-Belt Construction Equipment Co.
M. M. Jaxtheimer, Navy Crane Center
S. R. Gridley, *Alternate*, Navy Crane Center
P. R. Juhren, Morrow Equipment Co., LLC
M. J. Quinn, *Alternate*, Morrow Equipment Co., LLC
R. M. Kohner, Landmark Engineering Services
D. Duerr, *Alternate*, 2DM Associates, Inc.
A. J. Lusi, Jr., LuMark Consulting
K. Shinn, *Alternate*, K. J. Shinn, Inc.
E. K. Marburg, Columbus McKinnon Corp.
J. R. Burkey, *Alternate*, Columbus McKinnon Corp.
L. D. Means, Means Engineering and Consulting
D. A. Henninger, *Alternate*, Bridon American
M. W. Mills, Liberty Mutual Group
D. L. Morgan, Mission Support Alliance
W. E. Osborn, Ingersoll Rand
R. M. Parnell, Industrial Training International, Inc.
W. C. Dickinson, Jr., *Alternate*, Crane Industry Services, LLC
J. T. Perkins, Engineering Consultant
J. R. Schober, *Alternate*, American Bridge Co.
J. E. Richardson, U.S. Department of the Navy
K. Kennedy, *Alternate*, Navy Crane Center
D. W. Ritchie, Dave Ritchie Consultant, LLC
L. K. Shapiro, *Alternate*, Howard I. Shapiro and Associates
J. W. Rowland III, Consultant
D. A. Moore, *Alternate*, Unified Engineering
J. C. Ryan, Boh Bros. Construction Co.
A. R. Ruud, *Alternate*, Atkinson Construction
D. W. Smith, STI Group
S. K. Rammelsberg, *Alternate*, Chicago Bridge & Iron Co.
W. J. Smith, Jr., NBIS
J. Schoppert, *Alternate*, NBIS Claims and Risk Management
R. S. Stemp, Lampson International, LLC
E. P. Vliet, *Alternate*, Turner Industries Group
R. G. Strain, Advanced Crane Technologies, LLC
J. Sturm, Sturm Corp.
P. D. Sweeney, General Dynamics Electric Boat
B. M. Casey, *Alternate*, General Dynamics Electric Boat
J. D. Wiethorn, Haag Engineering Co.
R. C. Wild, U.S. Army Engineering District USACE
D. N. Wolff, National Crane/The Manitowoc Crane Group
J. A. Pilgrim, *Alternate*, Manitowoc Cranes



HONORARY MEMBERS

J. W. Downs, Jr., Downs Crane and Hoist Co.
J. L. Franks, Consultant
J. M. Klibert, Lift-All Co., Inc.
R. W. Parry, Consultant
P. S. Zorich, RZP International Ltd.

B30 INTEREST REVIEW GROUP

P. W. Boyd, Boeing Co.
J. D. Cannon, Regional Technical Crane Safety Specialist
M. J. Eggenberger, Bay Ltd.
H. A. Hashem, Saudi Aramco
J. Hui, School of Civil Engineering, Nanjing
A. C. Mattoli, Prowinch, LLC

M. W. Osborne, E-Crane International USA
G. L. Owens, Consultant
A. G. Rocha, Belgo Bekaert Arames
W. G. Rumburg, Crane Consultants, Inc.
C-C. Tsaor, Institute of Occupational Safety on Health

B30 REGULATORY AUTHORITY COUNCIL

C. Shelhamer, *Chair*, New York City Department of Buildings
W. M. James Dougherty, Jr., *Vice Chair*, Construction Plans Review Specialist
K. M. Hyam, *Secretary*, The American Society of Mechanical Engineers
G. Beer, Iowa OSHA
L. G. Campion, U.S. Department of Labor/OSHA

W. L. Cooper, Arizona Division of Occupational Safety and Health
C. Harris, City of Chicago — Department of Buildings
C. R. Smith, Pennsylvania Department of State, Bureau of Professional and Occupational Affairs
C. N. Stribling, Jr., Kentucky Labor Cabinet
C. Tolson, State of California, OSH Standards Board

B30.27 SUBCOMMITTEE PERSONNEL

R. J. Edwards, *Chair*, NBIS
W. J. Smith, Jr., *Alternate*, NBIS
J. L. Bury, Putzmeister America
L. D. DeMark, Sr., Equipment Training Solutions, LLC
K. Rask, Brundage-Bone Concrete Pumping, Inc.

D. R. Remus, Reed Manufacturing
J. Schoppert, NBIS Claims and Risk Management
R. Waterman, Brundage-Bone Concrete Pumping, Inc.
R. C. Wild, U.S. Army Engineering District USACE

آریا ایمن آوات



SAFETY STANDARD FOR CABLEWAYS, CRANES, DERRICKS, HOISTS, HOOKS, JACKS, AND SLINGS

B30 STANDARD INTRODUCTION

(14)

SECTION I: SCOPE

The ASME B30 Standard contains provisions that apply to the construction, installation, operation, inspection, testing, maintenance, and use of cranes and other lifting and material-movement related equipment. For the convenience of the reader, the Standard has been divided into separate volumes. Each volume has been written under the direction of the ASME B30 Standard Committee and has successfully completed a consensus approval process under the general auspices of the American National Standards Institute (ANSI).

As of the date of issuance of this Volume, the B30 Standard comprises the following volumes:

- B30.1 Jacks, Industrial Rollers, Air Casters, and Hydraulic Gantries
- B30.2 Overhead and Gantry Cranes (Top Running Bridge, Single or Multiple Girder, Top Running Trolley Hoist)
- B30.3 Tower Cranes
- B30.4 Portal and Pedestal Cranes
- B30.5 Mobile and Locomotive Cranes
- B30.6 Derricks
- B30.7 Winches
- B30.8 Floating Cranes and Floating Derricks
- B30.9 Slings
- B30.10 Hooks
- B30.11 Monorails and Underhung Cranes
- B30.12 Handling Loads Suspended From Rotorcraft
- B30.13 Storage/Retrieval (S/R) Machines and Associated Equipment
- B30.14 Side Boom Tractors
- B30.15 Mobile Hydraulic Cranes
(withdrawn 1982 — requirements found in latest revision of B30.5)
- B30.16 Overhead Hoists (Underhung)
- B30.17 Overhead and Gantry Cranes (Top Running Bridge, Single Girder, Underhung Hoist)
- B30.18 Stacker Cranes (Top or Under Running Bridge, Multiple Girder With Top or Under Running Trolley Hoist)
- B30.19 Cableways
- B30.20 Below-the-Hook Lifting Devices
- B30.21 Manually Lever-Operated Hoists
- B30.22 Articulating Boom Cranes

- B30.23 Personnel Lifting Systems
- B30.24 Container Cranes
- B30.25 Scrap and Material Handlers
- B30.26 Rigging Hardware
- B30.27 Material Placement Systems
- B30.28 Balance Lifting Units
- B30.29 Self-Erecting Tower Cranes
- B30.30 Ropes¹

SECTION II: SCOPE EXCLUSIONS

Any exclusion of, or limitations applicable to the equipment, requirements, recommendations, or operations contained in this Standard are established in the affected volume's scope.

SECTION III: PURPOSE

The B30 Standard is intended to

- (a) prevent or minimize injury to workers, and otherwise provide for the protection of life, limb, and property by prescribing safety requirements
- (b) provide direction to manufacturers, owners, employers, users, and others concerned with, or responsible for, its application
- (c) guide governments and other regulatory bodies in the development, promulgation, and enforcement of appropriate safety directives

SECTION IV: USE BY REGULATORY AGENCIES

These volumes may be adopted in whole or in part for governmental or regulatory use. If adopted for governmental use, the references to other national codes and standards in the specific volumes may be changed to refer to the corresponding regulations of the governmental authorities.

SECTION V: EFFECTIVE DATE

(a) *Effective Date.* The effective date of this Volume of the B30 Standard shall be 1 yr after its date of issuance.

¹ This volume is currently in the development process.



, installation, inspection, testing, maintenance, operation of equipment manufactured and constructed after the effective date of this Volume shall conform to the mandatory requirements of this Volume.

(b) *Existing Installations.* Equipment manufactured and facilities constructed prior to the effective date of this Volume of the B30 Standard shall be subject to the inspection, testing, maintenance, and operation requirements of this Standard after the effective date.

It is not the intent of this Volume of the B30 Standard to require retrofitting of existing equipment. However, when an item is being modified, its performance requirements shall be reviewed relative to the requirements within the current volume. The need to meet the current requirements shall be evaluated by a qualified person selected by the owner (user). Recommended changes shall be made by the owner (user) within 1 yr.

SECTION VI: REQUIREMENTS AND RECOMMENDATIONS

Requirements of this Standard are characterized by use of the word *shall*. Recommendations of this Standard are characterized by the word *should*.

SECTION VII: USE OF MEASUREMENT UNITS

This Standard contains SI (metric) units as well as U.S. Customary units. The values stated in U.S. Customary units are to be regarded as the standard. The SI units are a direct (soft) conversion from the U.S. Customary units.

SECTION VIII: REQUESTS FOR REVISION

The B30 Standard Committee will consider requests for revision of any of the volumes within the B30 Standard. Such requests should be directed to

Secretary, B30 Standard Committee
ASME Codes and Standards
Two Park Avenue
New York, NY 10016-5990

Requests should be in the following format:

- Volume: Cite the designation and title of the volume.
Edition: Cite the applicable edition of the volume.
Subject: Cite the applicable paragraph number(s) and the relevant heading(s).
Request: Indicate the suggested revision.
Rationale: State the rationale for the suggested revision.

Upon receipt by the Secretary, the request will be forwarded to the relevant B30 Subcommittee for consideration and action. Correspondence will be provided to

the requester defining the actions undertaken by the B30 Standard Committee.

SECTION IX: REQUESTS FOR INTERPRETATION

The B30 Standard Committee will render an interpretation of the provisions of the B30 Standard. Such requests should be directed to

Secretary, B30 Standard Committee
ASME Codes and Standards
Two Park Avenue
New York, NY 10016-5990

Requests should be in the following format:

- Volume: Cite the designation and title of the volume.
Edition: Cite the applicable edition of the volume.
Subject: Cite the applicable paragraph number(s) and the relevant heading(s).
Question: Phrase the question as a request for an interpretation of a specific provision suitable for general understanding and use, not as a request for approval of a proprietary design or situation. Plans or drawings that explain the question may be submitted to clarify the question. However, they should not contain any proprietary names or information.

Upon receipt by the Secretary, the request will be forwarded to the relevant B30 Subcommittee for a draft response, which will then be subject to approval by the B30 Standard Committee prior to its formal issuance.

Interpretations to the B30 Standard will be published in the subsequent edition of the respective volume, and will be available online at <http://cstools.asme.org/>.

SECTION X: ADDITIONAL GUIDANCE

The equipment covered by the B30 Standard is subject to hazards that cannot be abated by mechanical means, but only by the exercise of intelligence, care, and common sense. It is therefore essential to have personnel involved in the use and operation of equipment who are competent, careful, physically and mentally qualified, and trained in the proper operation of the equipment and the handling of loads. Serious hazards include, but are not limited to, improper or inadequate maintenance, overloading, dropping or slipping of the load, obstructing the free passage of the load, and using equipment for a purpose for which it was not intended or designed.

The B30 Standard Committee fully realizes the importance of proper design factors, minimum or maximum dimensions, and other limiting criteria of wire rope or chain and their fastenings, sheaves, sprockets, drums, and similar equipment covered by the standard, all of



are closely connected with safety. Sizes, strengths, and similar criteria are dependent on many different factors, often varying with the installation and uses.

These factors depend on

- (a) the condition of the equipment or material
- (b) the loads
- (c) the acceleration or speed of the ropes, chains, sheaves, sprockets, or drums
- (d) the type of attachments

(e) the number, size, and arrangement of sheaves or other parts

(f) environmental conditions causing corrosion or wear

(g) many variables that must be considered in each individual case

The requirements and recommendations provided in the volumes must be interpreted accordingly, and judgment used in determining their application.

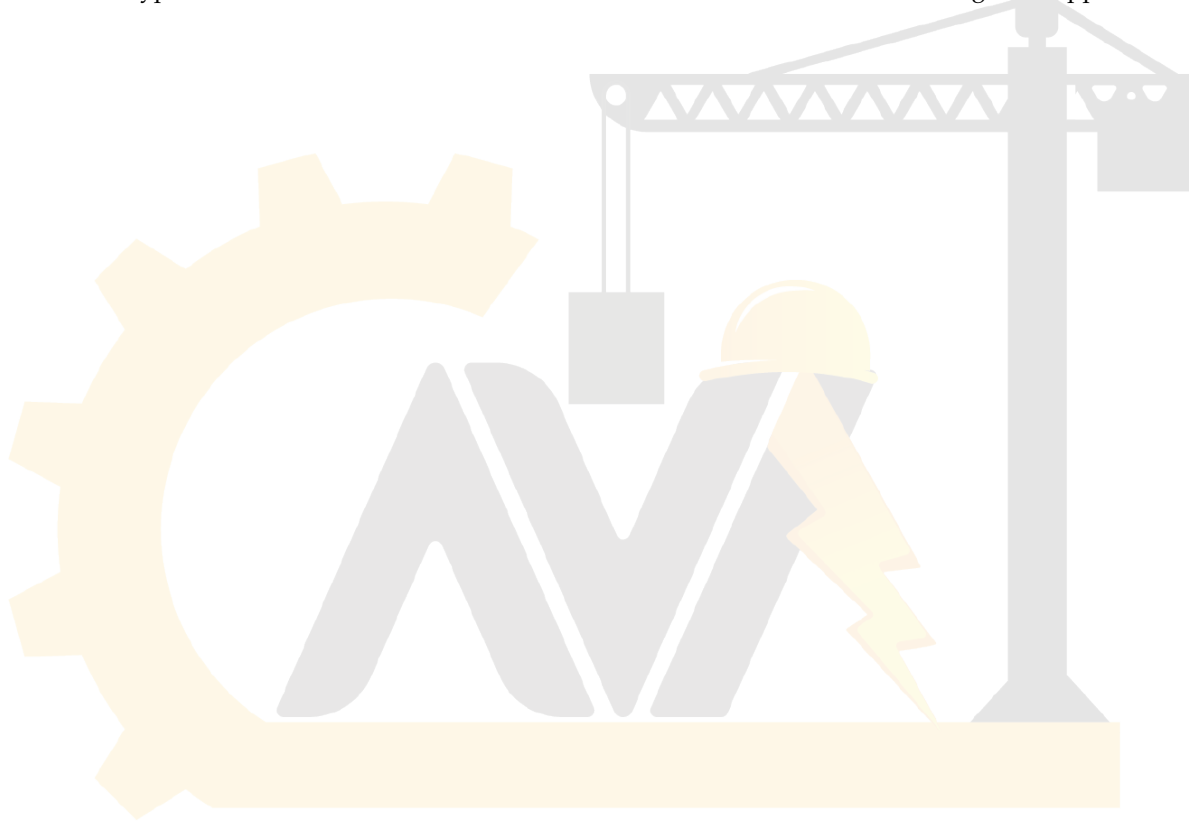

آریا ایمن آوات



ASME B30.27-2014 SUMMARY OF CHANGES

Following approval by the ASME B30 Committee and ASME, and after public review, ASME B30.27-2014 was approved by the American National Standards Institute on February 19, 2014.

ASME B30.27-2014 includes editorial changes, revisions, and corrections identified by a margin note, (14).

<i>Page</i>	<i>Location</i>	<i>Change</i>
ix	B30 Standard Introduction	Updated
1, 3, 4	27-0.2	(1) Definition of <i>designated person</i> deleted (2) Definition of <i>signalperson</i> added (3) Definition of <i>spotter</i> revised
	27-0.3	Updated
	27-0.4	Added
5	27-1.1.4	Last sentence in subpara. (d) added
6	27-1.1.8	Last sentence in subpara (c) added
	27-1.2.4	Added
	27-1.3	Last word in subpara. (d) revised
9	27-1.14	Added, and remaining sections renumbered
10	Figure 27-1.16-1	Title revised
12	27-2.1.3.4	First two words in subpara. (j) added
13	27-2.3	(1) Subparagraph (b) revised (2) Subparagraphs (i) and (j) added, and remaining subparagraphs relettered
14	27-3.1.1	Subparagraph (a)(2) revised
15	27-3.1.3	Added, and remaining paragraphs renumbered
19	27-3.1.5	Subparagraphs (j) and (k) added
21	27-3.1.6	Title and paras. 27-3.1.6.3 and 27-3.1.6.4 revised
23	Table 27-3.1.6.3-1	Revised in its entirety

MATERIAL PLACEMENT SYSTEMS

Chapter 27-0

Scope, Definitions, References, and Personnel Competence

SECTION 27-0.1: SCOPE

Volume B30.27, Material Placement Systems, includes provisions that apply to the construction, installation, operation, inspection, testing, and maintenance of trailer and truck-mounted material placement systems. Included in this are mechanical and hydraulic pea gravel systems, mobile telescoping boom conveyors, separate placing booms, and material placement accessories (see Figs. 27-0.1-1 through 27-0.1-4). Truck-mounted material placement systems can be either with or without an integral placing boom.

This Volume does not apply to the conveyor parts of mobile telescoping boom conveyors, mortar conveying and spraying machines, or dry mix shotcreting machines. The conveyor section of these machines is covered by ASME B20.1.

(14) SECTION 27-0.2: DEFINITIONS

concrete delivery hose: a flexible delivery hose having a coupling on each end.

control panel: controls mounted on the material placement system.

delivery systems: delivery lines, pipes, hoses, attachment components, and transfer valves, through which material is transported (see Fig. 27-0.1-4).

durably marked: a method of attaching information to a part, assembly, or machine that will satisfy the need for the marking, e.g., in the case of pipe or hose components, a marking that would last until the component is installed on a machine or put into use would be considered durably marked. For all other items required to be durably marked, the marking would last for the expected life of the part or machine under reasonably foreseeable circumstances.

end hose: a flexible concrete delivery hose that only has one coupling.

fixed guard: a component used to shield the user from machine interaction and attached by mechanical means. On material placement systems, temporary or removable guards do exist, such as a hopper grate that rotates

up for cleaning but is covered by a separate safety switch.

grooved connection: a type of pipe connection where a groove is machined or rolled directly into the outside of the pipe wall, creating a flange height of less than 0.15 in. (3.8 mm).

hopper: a receptacle for the material to be transported, which can include an agitator, a mixer, or both.

manual valve override: a mechanical valve actuator used to operate an electrically controlled valve in emergency or breakdown situations.

manual valve: a valve whose manual actuator is the only means of valve actuation.

maximum support force: the maximum force exerted on the supporting surface at any one outrigger.

metric connection: a type of pipe connection where the raised flange diameter, shape, and thickness are manufactured to metric specifications.

normal operating conditions: conditions during which a material placement system is performing functions within the scope of the original design. Under these conditions, no one other than the operator is on the material placement system.

outrigger: extendable or fixed members attached to the mounting base, which rest on supports at the outer ends used to support the machine.

placing booms: manual or power driven, slewable working devices, consisting of one or more extendable or foldable parts supporting the material delivery system, and directing the discharge into the desired location.

priority switching: transferring control of one or more functions from a control location to a different control location.

qualified person: a person who, by possession of a recognized degree in an applicable field, or certificate of professional standing, or who by extensive knowledge, training, and experience, has successfully demonstrated the ability to solve or resolve problems relating to the subject matter and work.

Fig. 27-0.1-1 Material Placement System: Truck-Mounted Concrete Pump With Integrated Placing Boom

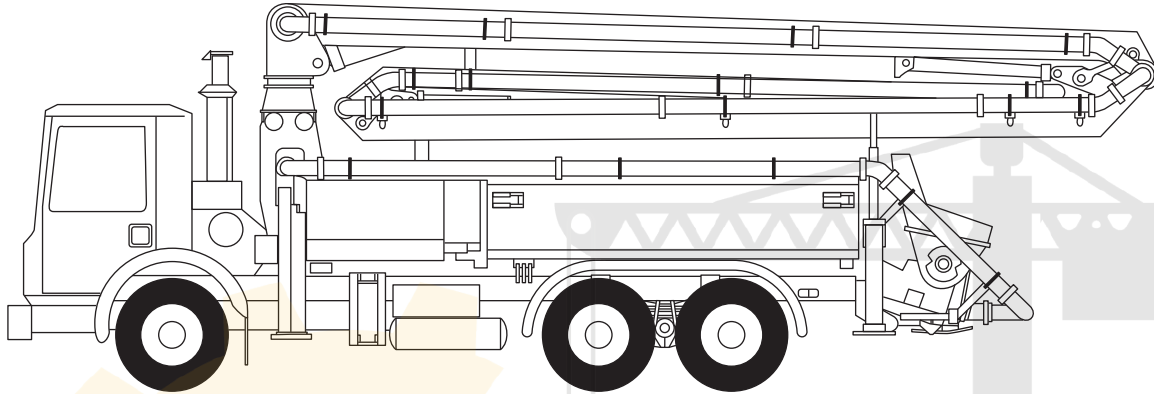

Fig. 27-0.1-2 Material Placement System: Separate Placing Boom

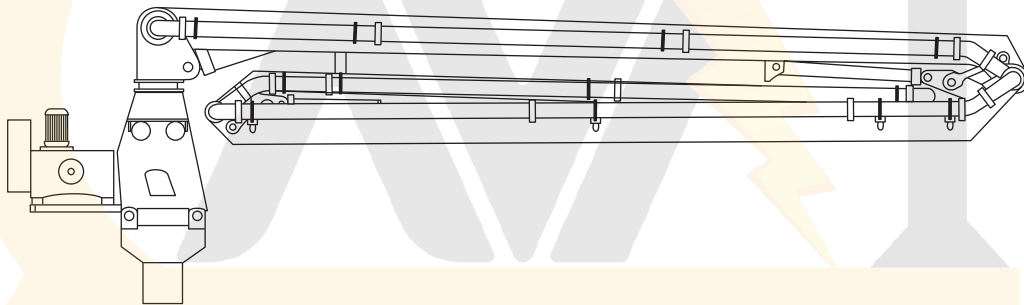

Fig. 27-0.1-3 Material Placement System: Truck-Mounted Telescopic Conveyor System

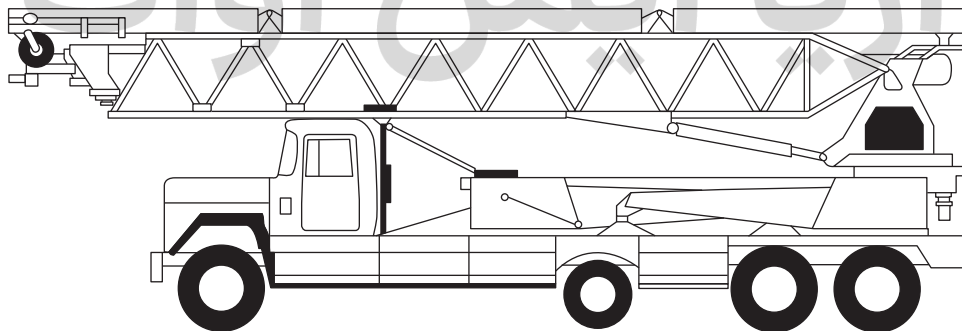
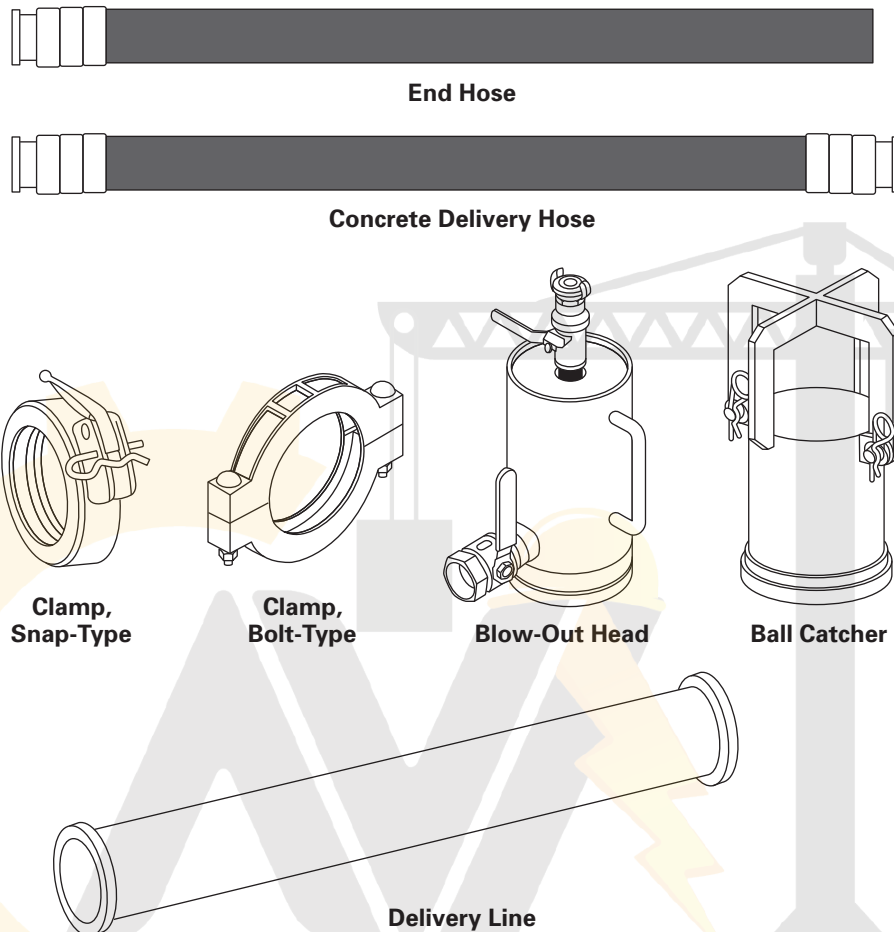

Fig. 27-0.1-4 Material Placement System: Examples of Delivery System Components



raised-end connection: a type of pipe connection where the raised flange is tapered and self aligning.

rated load: maximum allowable working load designated by the manufacturer.

remote control: a portable control device connected to the machine by a wire cable or linked by radio or other means.

safety device: a means placed in use for the specific purpose of preventing an unsafe condition.

sheave: a grooved wheel or pulley used with a rope to change the direction and point of application of a pulling force.

shortrigging: one or more outriggers not fully extended on the side away from the boom operational area.

signalperson: a person positioned at a vantage point where both the point of discharge and the operator of the material placement system can be seen and who relays operational signals to the operator.

specific type (of material placement system): a model, style, or size classification of material placement system (e.g.,

three section boom, four section boom, 50 meter class, conveyor).

spotter: a person positioned at a vantage point where the distance between a hazard and the material placement system can be clearly seen and evaluated and the material placement system's operator can be alerted if a pre-determined safety distance is compromised.

waterbox: the structural member holding the differential hydraulic cylinders in alignment with the material cylinders, which contains the flushing water.

SECTION 27-0.3: REFERENCE TO OTHER CODES AND STANDARDS (14)

The following is a list of publications referenced in this Volume:

- ANSI Z244.1-2008, Lock-out, Tag-out of Energy Sources — Minimum Safety Requirements
- ANSI Z535-2011, Product Safety Signs and Labels
- Publisher: American National Standards Institute (ANSI), 25 West 43rd Street, New York, NY 10036 (www.ansi.org)



2011, Mobile and Locomotive Cranes
2012-2010, Articulating Boom Cranes

Publisher: The American Society of Mechanical Engineers (ASME), Two Park Avenue, New York, NY 10016-5990; Order Department: 22 Law Drive, P.O. Box 2900, Fairfield, NJ 07007-2900 (www.asme.org)

ISO 3411:2007, Earth-moving machinery — Human physical dimensions of operators and minimum operator space envelope¹

ISO 7000:2012, Graphical symbols for use on equipment — Registered symbols¹

ISO 7296-1:1991, Cranes — Graphic symbols — Part 1: General¹

ISO 13850:2006, Safety of machinery — Emergency stop — Principles for design¹

¹ May also be obtained from American National Standards Institute (ANSI), 25 West 43rd Street, New York, NY 10036.

Publisher: International Organization for Standardization (ISO), Central Secretariat, 1, ch. de la Voie-Creuse, Case postale 56, CH-1211 Genève 20, Switzerland/Suisse (www.iso.org)

SAE J2703-2008, Cranes — Access and Egress

Publisher: Society of Automotive Engineers (SAE International), 400 Commonwealth Drive, Warrendale, PA 15096 (www.sae.org)

27-0.4: PERSONNEL COMPETENCE

(14)

Persons performing the functions identified in this Volume shall meet the applicable qualifying criteria stated in this Volume and shall, through education, training, experience, skill, and physical fitness, as necessary, be competent and capable to perform the functions as determined by the employer or employer's representative.

آریا ایمن آوات

Chapter 27-1 Construction and Installation

SECTION 27-1.1: MARKINGS

27-1.1.1 Placing Boom Rating and Identification Markings

(a) The following information shall be legibly marked on a durable identification plate on the placing boom:

- (1) manufacturer, supplier, or importer
- (2) year of manufacture
- (3) fabrication (serial) number
- (4) type or model
- (5) maximum design working pressure in the hydraulic system
- (6) rated load

(a) for placing booms, maximum weight per foot of delivery system when filled with material based on 150 lb/ft³ (2 400 kg/m³)

(b) for conveyor, maximum weight of material per foot of belt

(b) Power rating for electrical equipment above 24 V (voltage, frequency, power, amperage draw).

(c) Placing booms shall be clearly marked with a label affixed near the tip elbow warning about the use of improper diameter delivery system.

(d) A durable plate showing the maximum weight of the hanging system components shall be attached to the boom tip.

(e) Placing booms shall not be used to move freely suspended loads. A safety sign shall be placed on the machine to this effect.

27-1.1.2 Material Placement System Rating and Identification Markings

The following information shall be legibly marked on a durable identification plate on the lower support structure of the material placement system:

- (a) manufacturer, assembler, supplier, or importer
- (b) year of manufacture
- (c) fabrication (serial) number
- (d) type or model
- (e) maximum working pressure of material placement system hydraulic circuit(s)
- (f) maximum material pressure, if applicable
- (g) maximum working pressure supplied to the boom hydraulic system

27-1.1.3 Straight Delivery Pipes Rating and Identification Markings

The following information shall be legibly and durably marked on straight delivery pipes longer than 12 in. (305 mm):

- (a) manufacturer or supplier (name or code)
- (b) nominal diameter
- (c) maximum working pressure, when new
- (d) weight of pipe per foot when filled with material based on 150 lb/ft³ (2 400 kg/m³)

27-1.1.4 Delivery System Elbow Rating and Identification Markings

(14)

The following information shall be legibly and durably marked on delivery system elbows:

- (a) Manufacturer or supplier (name or code).
- (b) Nominal diameter.
- (c) Maximum working pressure, when new.
- (d) Weight of elbow when filled with material based on 150 lb/ft³ (2 400 kg/m³). Elbows installed between the concrete valve and outlet side of the turret pipe are excluded from weight-marking requirements.

27-1.1.5 Delivery System Hose Rating and Identification Markings

The following information shall be legibly marked on the delivery hose:

- (a) manufacturer
- (b) nominal diameter
- (c) working pressure, when new
- (d) weight
 - (1) for delivery hose, pounds per foot when filled with material based on 150 lb/ft³ (2 400 kg/m³)
 - (2) for end hose, total weight of component when filled with material based on 150 lb/ft³ (2 400 kg/m³)

27-1.1.6 Safety Signs

Safety signs shall meet the requirements of ANSI Z535, parts 1, 3, and 4.

27-1.1.7 Hand Signals

Hand signals in accordance with para. 27-3.3.2 shall be posted conspicuously on the material placement system or placing boom.



27-1.1.8 Lifting System Accessory Identification Markings

The following information shall be legibly and durably marked on shut-off valves, clamps, and reducers:

- (a) Manufacturer or supplier (name or code).
- (b) Maximum working pressure, when new.
- (c) Weight of the component, with concrete at 150 lb/ft³ (2 400 kg/m³). Accessories installed between the concrete valve and outlet side of the turret pipe are excluded from weight-marking requirements.

27-1.1.9 Air Compressor Rating Markings

If the machine is equipped with an air compressor, the following information shall be legibly marked on a durable identification plate:

- (a) at the compressor
 - (1) volume stream
 - (2) maximum working pressure
 - (3) highest working speed per minute
 - (4) installed engine performance in kW or HP
 - (5) power rating for high voltage (above 24 V) electrical equipment (voltage, frequency, power, amperage draw)
- (b) at the air chamber
 - (1) permissible working pressure of the pressure vessel
 - (2) volume of the pressure vessel (e.g., in gallons)
 - (3) the construction identification for pressure vessels

NOTE: This requirement does not apply to any part of the air system installed by the chassis manufacturer.

SECTION 27-1.2: MOBILE MATERIAL PLACING BOOM CONSTRUCTION

27-1.2.1 Structural

The material placement system shall be designed and constructed so when operated in accordance with manufacturer's intended use, stresses in load-bearing components shall not exceed structural limits.

27-1.2.2 Stability

The material placement system shall be designed and constructed so three outriggers of the machine support structure remain in contact with the support surface under the following conditions:

- (a) The unit is set up within 3 deg of level.
- (b) 125% of the rated static load is applied to the boom. Stability of a representative model of the truck-mounted material placement system with integral placing boom shall be verified by performing the test described in para. 27-2.2.2.

27-1.2.3 Lifting Attachments

(a) Machines or their parts designed to be lifted by cranes or other lifting devices shall be equipped with suitable attachment points.

(b) Attachment points shall be clearly marked for identification purposes.

(c) Any component weighing more than 500 lb (227 kg) and having identified lifting attachment points shall have the component weight legibly and durably marked on the component.

27-1.2.4 Replacement Parts

Replacement parts shall be manufactured using at least the same design factors of the parts they are intended to replace.

SECTION 27-1.3: WORK PLATFORMS, ACCESS WALKWAYS, AND GANGWAYS

(a) Work platforms, access walkways, and gangways shall be a skid-resistant type.

(b) Access for maintenance, assembly, dismantling, and testing should be provided.

(c) The machine designer should consider weather conditions in the design phase to minimize adverse effects, such as pooling of water and accumulation of ice and mud.

(d) Access provisions for getting on and off the material placement system shall be in accordance with SAE J2703.

SECTION 27-1.4: ELECTRICAL INSTALLATIONS

(a) Each electrically powered placing boom shall have a power disconnect switch mounted at or near the base of the placing boom. This switch shall have provisions to apply lockout/tagout procedures in accordance with ANSI Z244.1.

(b) Electrical equipment shall be located or guarded so that live parts are not exposed to inadvertent contact under normal operating conditions.

(c) Electrical equipment shall be protected from concrete, dirt, grease, oil, and moisture infiltration. Fixtures, wiring, and connections exposed to the weather shall be of weather-resistant type.

(d) Overload protection shall be provided for each individual motor.

SECTION 27-1.5: ERGONOMICS

Control panels, manual override levers, access doors, and covers shall be located to provide access to accommodate human physical dimensions as outlined in ISO 3411.



27-1.6: OUTRIGGERS

The machine shall be constructed so that the operator can see the area of outrigger movement from the outrigger control station.

(b) Means shall be provided to hold all outriggers in the retracted position while traveling and in the extended position when set for operating.

(c) If equipped with detachable outrigger floats (feet), they shall be securable to the outrigger jack.

(d) The maximum downward force imposed by the outrigger shall be marked at each outrigger.

(e) Power-actuated jacks, where used, shall be provided with the means (such as integral load hold check valves on hydraulic cylinders, mechanical locks, etc.) to prevent loss of support under load.

SECTION 27-1.7: CONTROLS AND INDICATORS

27-1.7.1 Emergency Stops

(a) Each machine shall be equipped with an emergency stop system.

(b) The emergency stop system actuator(s) shall be visible, accessible, and easy to operate.

(c) The machine shall be equipped with an emergency stop actuator at control panel(s) and at the remote control device(s). The machine may be fitted with additional emergency stop actuators.

(d) Emergency stops shall

(1) cause the machinery to stop instantaneously, taking into account stored energy.

(2) prevent the automatic restart of the machine. The machine will have to be started intentionally.

(3) be constructed according to ISO 13850.

27-1.7.2 Outriggers

(a) Control devices for slewable, telescopic, or adjustable outriggers shall return to the neutral position when released.

(b) Control devices for outriggers shall be situated outside of the area of outrigger movement, or access to the area of outrigger movement shall be otherwise restricted.

(c) Control circuits for the outriggers shall be independent of each other.

(d) Outrigger control systems shall be designed so they are nonfunctional when the machine is locked out in accordance with ANSI Z244.1.

27-1.7.3 General Control Requirements

(a) If there are multiple control locations, the same operation (e.g., start, close, open) shall only be possible from one location at a time. Priority switching (either manual or automatic) shall be used to transfer the control between the control locations.

(b) Control devices shall be designed to prevent unintentional operation.

(c) Control systems shall be designed so that they are nonfunctional when the equipment is locked out in accordance with ANSI Z244.1.

(d) All control devices shall be constructed, arranged, and marked so their function is indicated.

(e) Control devices that activate boom movements shall return to the neutral position when released.

27-1.7.4 Hour Meters

Hour meters shall be installed on any material placement system requiring maintenance based on hours.

27-1.7.5 Standardized Joystick Movements

Joystick movements shall be consistent with the standardized movements shown in Fig. 27-1.7.5-1.

SECTION 27-1.8: GUARDS

(a) Any hazard that is inaccessible is considered guarded by location.

(b) A fixed guard shall be installed for rotating shafts. The underside of a mobile truck chassis-mounted material placement system is considered guarded by location.

(c) A fixed guard shall be installed over V-belts, drive pulleys, chains, sprockets, gears, and other moving parts.

(d) All exhaust pipes shall be guarded or insulated to prevent contact with personnel when performing routine duties.

(e) Whenever guarding is impractical, prominent means such as safety signs or lights shall be provided at the point of hazard in lieu of guarding.

(f) A fixed guard shall be installed to prevent unintentional access to the moving parts in the waterbox.

SECTION 27-1.9: MOBILE AND STATIONARY PLACING BOOMS

27-1.9.1 Placing Booms

(a) Mobile placing booms shall be equipped with a remote control with sufficient range to operate the material placement system from a distance equivalent to the boom length.

(b) The lifting and lowering speed at the end of the boom shall not exceed 3 ft/sec (1 m/s) when activating any one section.

(c) The lifting and lowering speed at the end of the boom shall not exceed 10 ft/sec (3 m/s) when activating any combination of boom functions.

(d) The horizontal slewing speed at the end of the boom shall not exceed 5 ft/sec (1.5 m/s).

(e) An integrally mounted holding device, such as a load hold check valve, shall be provided with each hydraulic cylinder on each boom section to prevent uncontrolled movement of the boom in the event of a hydraulic system failure (e.g., supply hose rupture).

Fig. 27-1.7.5-1 Standardized Joystick Movement

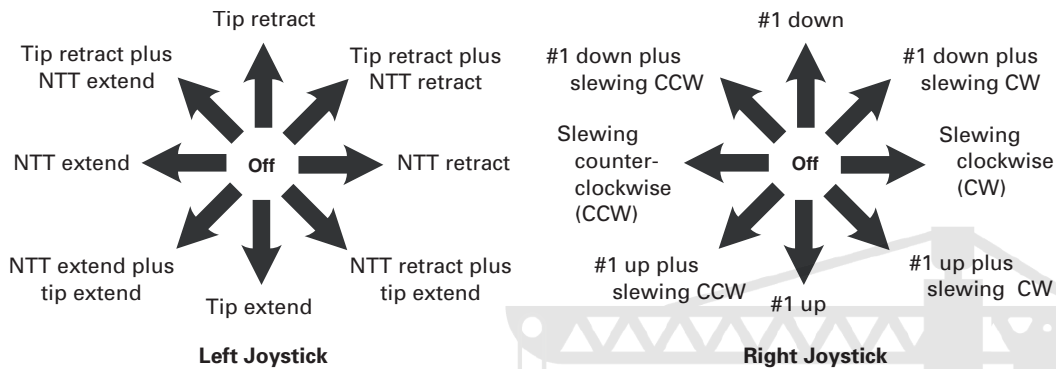

GENERAL NOTE: NTT = next to tip. It means the section of boom attached to the tip section. For example, on a four-section boom, NTT would be number 3. On a three-section boom, NTT would be number 2. Each remote box will show the configuration correctly for the unit it will run. There is no standard for any sections not listed, meaning that extra sections may have pushbuttons, additional joysticks, or some other configuration.

27-1.9.2 Boom Tip Attachments

Provisions shall be made so that attachments suspended from the boom tip can be restrained.

SECTION 27-1.10: DELIVERY SYSTEMS

27-1.10.1 Delivery Line

Delivery system components supplied with a machine shall have a working pressure rating at least equal to the maximum pressure of the machine configuration, as delivered.

27-1.10.2 Delivery System Components

(a) New delivery system components shall meet the following minimum ratios of burst pressure versus working pressure:

- (1) end hoses — 2:1
- (2) boom pipes and boom couplings — 2:1
- (3) other concrete placing line and accessories, including concrete delivery hose, delivery line, valves, and couplings — 2:1

(b) Delivery system components for boom units shall have a minimum of 85 bar (1 233 psi) working pressure, when new. Any boom unit capable of exceeding 85 bar material pressure shall have the delivery system's working pressure requirements clearly marked on the boom.

(c) Pipeline couplings shall be constructed to minimize the possibility of inadvertent opening.

(d) Delivery systems with grooved connections [a groove machined or rolled directly into the outside of the pipe wall, creating a flange height of less than 0.15 in. (3.8 mm)] shall not be used on placing booms or on lay-down delivery line or hoses.

(e) Air blow-out caps shall be equipped with a separate bleed-off valve to allow the operator to relieve pressure in the system.

SECTION 27-1.11: LOSS OF POWER

Interruption of power to the material placement system shall not cause a hazardous situation.

SECTION 27-1.12: REMOTE STARTING

A material placement system powered by the vehicle engine shall be designed so the engine cannot be started from a remote location unless the drive axles are disengaged.

SECTION 27-1.13: MANUALS

The manufacturer, supplier, or importer shall furnish with each material placement system information applicable to the following:

- (a) installation
- (b) hazards
- (c) lockout/tagout procedures
- (d) operation
- (e) inspection
- (f) testing
- (g) lubrication
- (h) maintenance
- (i) parts
- (j) wiring diagram (may be supplied separately)
- (k) hydraulic diagram (may be supplied separately)
- (l) safety sign ordering information and location guide (may be supplied separately)
- (m) spare parts list containing relevant safety-related spare parts, such as relief valves, check valves, and guards, with part location



27-1.14 TRANSLATION OF NON-ENGLISH DOCUMENTATION INTO ENGLISH

(a) The wording of non-English safety information and manuals regarding use, inspection, and maintenance shall be translated into English by professional translation industry standards, including, but not limited to

(1) translation of the complete paragraph message, instead of word-by-word

(2) grammatical accuracy

(3) respectfulness of the source document content without omitting or expanding the text

(4) translating the terminology accurately

(5) reflecting the level of sophistication of the original document

(b) The finished translation shall be verified for compliance with (a)(1) through (a)(5) above by a qualified person having an understanding of the technical content of the subject matter.

(c) Pictograms used to identify controls shall be described in the manuals. The pictograms should comply with ISO 7000, ISO 7296-1, or another recognized source, if previously defined. The text of the description shall meet the criteria of (a) and (b) above.

(d) Any non-English documentation provided in addition to English shall be translated and reviewed in accordance with the requirements listed above.

SECTION 27-1.15: FUEL AND EXHAUST SYSTEMS

(a) The material placement system's fuel system components shall be compatible with the fuel used.

(b) The fuel system filling area shall be located away from potential fuel ignition sources on the machine.

(c) Engine exhaust gases shall be piped to the outside of the cab and discharged in a direction away from the operator and other locations where personnel would be performing routine duties.

SECTION 27-1.16: HOPPERS

(a) Grates of hoppers of reversible pumps that can be opened without a tool or that have to be opened more

than once a day shall be configured in such a way that when they are opened, operation of the concrete pump and agitator is stopped, and they shall be secured against restarting while the grate remains open.

(b) A valve mechanism capable of crushing, tearing, or cutting shall be guarded by a cover grate on the opening of the charging hopper within the dimensions shown in Fig. 27-1.16-1, or the machine shall be constructed in such a way that the crushing points are inaccessible.

(c) Agitators or screw conveyors located inside of hoppers shall be guarded with a cover grate constructed within the dimensions shown in Fig. 27-1.16-1.

(d) Power-operated hopper cover grates or hopper covers shall have a control device with self-acting reset. The location of the control levers shall be far enough away from the crushing points to prevent contact with the moving parts.

(e) A grate or cover that can be raised shall be securable in the open position or constructed in such a way that it will not close unintentionally.

SECTION 27-1.17: PUMP PRESSURE RELEASE

27-1.17.1 Reversible Pumps

Reversible pumps shall be constructed so pressure caused by blockages in the delivery system can be removed by reversing pumping.

27-1.17.2 Nonreversible Pumps

Nonreversible pumps shall be constructed so personnel are not endangered by the forceful ejection of concrete when removing the pressure caused by blockages. This can be accomplished by

(a) a restraining device allowing the pump manifold to be opened safely

(b) a pressure release gate in the manifold

(c) any other pressure release mechanism that will not endanger personnel when used

Fig. 27-1.16-1 Grates and Hoppers

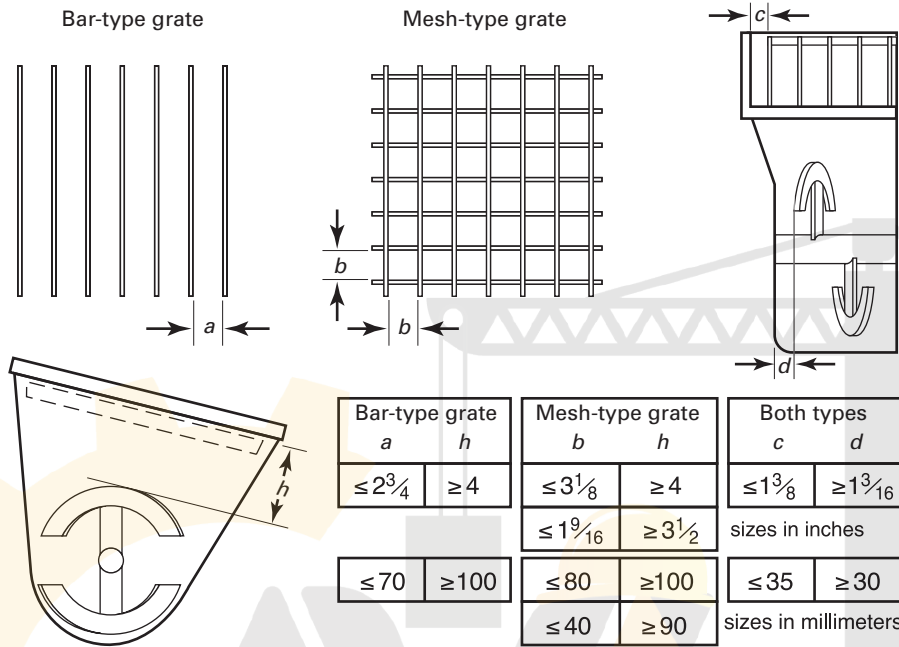

آریا ایمن آوات

Chapter 27-2

Inspection, Testing, and Maintenance

SECTION 27-2.1: INSPECTION

27-2.1.1 Inspection Classifications

(a) *Initial Inspection.* Prior to initial use, all new, repaired, or altered material placement systems shall be inspected by a qualified person to verify compliance with the provisions of this Volume.

(b) *Frequent and Periodic Inspections.* The inspection procedure for material placement systems in regular service is divided into two general classifications based upon the intervals at which the inspections are to be performed. The inspection intervals are dependent upon the nature of the components and degree of safety, exposure to wear, malfunction, or deterioration. The two general classifications of regular inspection are designated as “frequent” and “periodic.”

27-2.1.2 Frequent Inspection

27-2.1.2.1 Frequent inspection shall be performed by a designated person at daily to monthly intervals and shall include observations prior to and during operation.

27-2.1.2.2 A designated person shall determine whether conditions found during the inspection constitute a hazard and whether a more detailed inspection is required.

27-2.1.2.3 Frequent inspection of the material placing boom and structural support system shall include, as applicable

- (a) safety devices, such as holding valves, guards, and interlocks, for proper operation
- (b) boom controls for proper operation and engagement
- (c) boom and outrigger hooks, straps, and latches for proper operation and engagement
- (d) hydraulic hoses for wear, rubbing, and cracking
- (e) hydraulic oil level
- (f) hydraulic oil leaks
- (g) remote control boxes and cables for proper operation, exposed wires, broken controls, missing control guards, or broken plugs
- (h) boom and outrigger structures for visible deformations, cracks, and damage
- (i) boom and outrigger pins for visible wear, damage, and missing hardware
- (j) tires for sufficient tread, proper inflation, cuts, and loose lug nuts

(k) proper loading of accessories to prevent loss while traveling

(l) proper lubrication of moving parts

27-2.1.2.4 Frequent inspection of the delivery system components shall include

(a) boom delivery system for

(1) minimum wall thickness to withstand the maximum material pressure, according to the manufacturer’s instructions

(2) dents or cracks

(3) missing locking pins

(4) leaking gaskets

(b) delivery system hoses for

(1) internal wear, according to the manufacturer’s instructions

(2) separation of the ferrule from the hose

(3) bulges, kinks, soft spots, cuts, or abraded areas, which may indicate broken or misplaced reinforcement

(4) presence of hardened concrete

(c) couplings for

(1) cracked, broken, distorted, or missing components

(2) proper operation of the adjusting nut, if so equipped

(3) concrete preventing proper operation

(4) system compatibility

(d) separately laid pipeline components for

(1) sufficient wall thickness to withstand the maximum material pressure of the material placement system, according to the manufacturer’s instructions

(2) dents, holes, or deformed ends

(3) the presence of old concrete inside the pipeline

(e) cables or slings used to secure hanging system components

(f) missing or damaged safety signs and operational labels

27-2.1.2.5 Frequent inspection of conveyor system components shall include

(a) conveyor belts for proper tension, proper alignment (i.e., in center of pulleys and rollers), and unusual wear (e.g., grooves or holes in belt)

(b) telescope drive cable or chain for excessive wear, damage, and proper tension

(c) sheaves for excessive wear or damage

(d) chains for excessive wear or damage

(e) chain sprockets for excessive wear or damage



- ... pulleys for proper adjustment, concrete
... excessive wear, or damage
- ... rods for proper adjustment or damage
- (h) scraper blade assemblies for excessive wear, damage, concrete buildup, or improper adjustment
- (i) hydraulic cylinder pins or anchors for excessive wear or damage
- (j) missing or loose mounting bolts, guards, or hardware
- (k) missing or damaged safety signs and operational labels
- (l) proper lubrication of moving parts

27-2.1.3 Periodic Inspections

27-2.1.3.1 Complete inspections of the material placing boom and structural support system shall be performed by a qualified person at the intervals listed below

- (a) first 5 yr — every 2,000 working hours, or at least once per year, whichever occurs first
- (b) 5 yr to 10 yr — every 1,000 working hours, or at least once per year, whichever occurs first
- (c) 10 yr and older — every 500 working hours, or at least once per year, whichever occurs first

27-2.1.3.2 A qualified person shall inspect

- (a) the placing boom for corrosion, cracking, deformation, or damage
- (b) the structural support system for corrosion, cracking, deformation, or damage
- (c) measured boom pin wear

27-2.1.3.3 If the inspection of para. 27-2.1.3.2 reveals a condition determined as hazardous, the machine shall be taken out of service until repairs are made.

- (14) **27-2.1.3.4** The periodic inspection shall include the requirements of frequent inspections (paras. 27-2.1.2.3 and 27-2.1.2.4) and in addition, the following items, as applicable, which can be inspected by a designated person:

- (a) measured gear lash and bearing clearances
- (b) loose or missing fasteners, including pins or pin retainers
- (c) slewing and telescope bearings, gear drives, and gears for mounting and wear
- (d) hydraulic component mounting(s)
- (e) missing or loose mounting bolts to the carrier chassis
- (f) truck mounting for cracks, deformation, or damage
- (g) hydraulic and pneumatic pumps and motors
- (1) loose bolts or fasteners
- (2) leaks at joints between sections
- (3) shaft seal leaks
- (4) unusual noises or vibration

- (5) loss of operating speed
- (6) excessive heating of the fluid
- (7) loss of pressure
- (h) hydraulic and pneumatic valves
- (1) cracks in valve housing
- (2) improper return of spool to neutral position
- (3) leaks at spools or joints
- (4) sticking spools
- (5) failure of relief valves to attain correct pressure setting
- (6) relief valve pressures shall be checked as specified by the manufacturer
- (i) hydraulic and pneumatic cylinders
- (1) drifting caused by fluid leaking across the piston
- (2) rod seals leakage
- (3) leaks at welded joints
- (4) scored, nicked, or dented cylinder rods
- (5) dented case (barrel)
- (6) loose or deformed rod eyes or connecting joints
- (j) controls marking, operational labels, and safety signs are present, attached in the appropriate place, and legible
- (k) concrete pump components (as recommended by the manufacturer)

27-2.1.3.5 A designated person shall determine whether conditions found during the inspection of para. 27-2.1.3.4 constitutes a hazard and whether a more detailed inspection is required.

27-2.1.4 Material Placement Systems Not in Regular Use

A material placement system that has been idle for a period of 1 mo or more shall be given a frequent inspection before being placed in service.

27-2.1.5 Inspection Records

Dated periodic inspection records shall be maintained by a designated person.

SECTION 27-2.2: TESTING

27-2.2.1 Operational Testing

All new production material placement systems shall be tested by the manufacturer after final assembly to verify

- (a) proper operation of all safety devices
- (b) proper operation of all controls
- (c) proper positioning of all boom sections in all intended operational positions
- (d) proper positioning of outriggers in all intended operational positions
- (e) proper setting of hydraulic pressures and relief settings
- (f) no unusual vibrations or noise



The boom will support the intended load without sagging down in excess of the manufacturer's specification.

- (h) proper operation and engaging of latching and locking devices
- (i) compliance with the requirements of this Volume

27-2.2.2 Manufacturer's Stability Test

A representative unit of each model and chassis in each intended operation configuration shall be tested for stability. A written test report shall be kept on file. The stability test shall comply with the following minimum guidelines:

(a) The margin of stability shall be determined by calculation of the static load imposed by the boom and its systems and mountings, plus the maximum allowable load imposed on the boom by the material in the delivery system, including end hose, and the boom rotated to the least stable position. The calculation of the material load shall be based on material with a bulk density of 150 lb/ft³ (2 400 kg/m³).

(b) If having the outriggers, extendable axles, or other means in use are part of the normal configuration to meet the stability requirements, they shall be set per manufacturer's instructions.

(c) The test load equivalent to 125% of the rated load (1.25 times) shall be applied to the boom to verify its stability. The manufacturer shall determine the most critical configuration(s) of the unit for this test. Ballast may be applied to the unit that is equivalent to the weight of material in the hopper (filled to the top of delivery cylinder opening), one delivery cylinder (filled 75%), and the deck delivery line.

(d) None of the stability testing shall cause permanent deformation to any component. While being tested, three outriggers shall remain in contact with the support surface. During the stability test, the lifting of one outrigger on the opposite side of the load does not necessarily indicate a condition of instability.

27-2.2.3 Postmaintenance Test

Before being returned to service after maintenance is performed, any altered, replaced, or repaired components shall be tested for proper operation per the manufacturer's recommendations.

SECTION 27-2.3: MAINTENANCE

(14)

(a) The manufacturer shall provide a recommended preventive maintenance schedule to minimize the possibility of mechanical failures and excessive and unnecessary wear.

(b) A preventive maintenance program shall be established and should be based on the recommendations outlined in the material placement system manufacturer's manual. Dated records of maintenance performed should be maintained.

(c) Under severe conditions, or if excessive wear is noted, scheduled intervals should be adjusted to prevent breakdowns and excessive wear.

(d) Maintenance shall be performed by a designated person.

(e) Maintenance should be performed in accordance with the manufacturer's recommended procedures.

(f) All guards shall be reinstalled, all safety devices reactivated, and maintenance equipment removed after maintenance is completed.

(g) Welding on the boom, outrigger, or structural member shall be performed in accordance with the recommendations of the manufacturer. In the absence of a manufacturer's recommendation, the welding can be performed per the recommendations of a qualified person.

(h) Replacement parts shall meet or exceed the manufacturer's specifications.

(i) Repairs shall be made according to the manufacturer's instructions, if instructions are available. Absent instructions from the manufacturer, repairs shall be made according to the directions of a qualified person.

(j) Repairs shall return the material placement system to a condition of structural, mechanical, and functional integrity to permit operation of the machine in accordance with the manufacturer's published performance specifications.

(k) Missing or illegible operational labels and safety signs shall be replaced.

(l) Lubrication should be performed according to the manufacturer's recommendations and procedures.

(m) Delivery of lubricant to intended points should be verified.

(n) Machinery shall not be in operation while lubricants are being applied, unless equipped for automatic or remote lubrication or the lubrication point specifically requires movement for the lubricating procedure.



Chapter 27-3 Operation

SECTION 27-3.1: QUALIFICATIONS FOR AND CONDUCT OF OPERATORS AND OPERATING PRACTICES

(14) 27-3.1.1 Operators

(a) Material placement systems shall be operated only by the following personnel:

(1) persons who have met the requirements of paras. 27-3.1.2(a) through (c).

(2) persons who have met the requirements of para. 27-3.1.2(d) and are training for the type of material placement system being operated. Trainees shall be under the supervision of a designated person. The number of trainees permitted to be supervised by a single designated person, the physical location of the designated person while supervising, and the type of communication required between the designated person and the trainee shall be determined by a qualified person.

(3) maintenance personnel who have completed all operator trainee qualification requirements and demonstrated operational ability as defined in para. 27-3.1.2(b)(4). Operation by these persons shall be limited to those material placement system functions necessary to perform maintenance on the machine or verify the performance of the material placement system after maintenance has been performed.

(4) inspectors who have completed all operator trainee qualification requirements and demonstrated operational ability as defined in para. 27-3.1.2(b)(4). Operation by these persons shall be limited to those material placement system functions necessary to accomplish the inspection.

(b) During material placement system operations, no one other than the personnel specified in (a) above shall be within 5 ft (1.5 m) of the material placement system or climb up on the machine, with the exception of supervisors, those specified persons authorized by supervisors whose duties require them to do so in the performance of their duties, or concrete truck drivers having the knowledge and permission of the material placement system operator.

27-3.1.2 Qualifications for Operators

Operators shall be required to successfully meet the qualifications for the specific type of material placement system they are operating.

(a) Operator and operator trainees shall meet the following physical qualifications unless it can be shown

that failure to meet the qualifications will not affect the operation of the material placement system. In such cases, specialized clinical or medical judgments and tests may be required.

(1) vision of at least 20/30 Snellen in one eye, with or without corrective lenses.

(2) ability to distinguish colors, regardless of position, if color differentiation is required.

(3) adequate hearing, to meet operational demands, with or without a hearing aid.

(4) sufficient strength, endurance, agility, coordination, and speed of reaction to meet the operational demands.

(5) shall have normal depth perception, field of vision, reaction time, manual dexterity, coordination, and no tendencies to dizziness or similar undesirable characteristics.

(6) should successfully pass with a negative result a substance abuse test. The level of testing will be determined by the standard practice for the industry where the material placement system is employed, and this test shall be confirmed by a recognized laboratory service.

(7) no evidence of physical defects or emotional instability that could render a hazard to the operator or others or that in the opinion of the examiner could interfere with the operator's performance. If evidence of this nature is found, it may be sufficient cause for disqualification.

(8) evidence that an operator is subject to seizures or loss of physical control shall be sufficient reason for disqualification. Specialized medical tests may be required to determine these conditions.

(b) Operator requirements shall include, but not be limited to, the following:

(1) evidence of successfully passing a physical examination as defined in (a) above.

(2) satisfactory completion of a written examination covering operational characteristics, controls, power line avoidance, stability requirements, and emergency control skills, such as response to fire, power line contact, loss of stability, or control malfunction, as well as characteristic and performance questions appropriate to the material placement system type for which qualification is sought.

(3) operators shall demonstrate their ability to read and comprehend the material placement system manufacturer's operation and maintenance instruction materials.



completing an operation test demonstrating proficiency in handling the specific type material placement system, including both prestart and poststart inspection, setup procedures, maneuvering skills, shutdown, and securing procedures.

(5) operators shall demonstrate understanding of the applicable sections of the B30 Standard and federal, state, and local requirements.

(c) Operators who have successfully qualified for a specific type material placement system shall be required to be requalified if supervision deems it necessary. Requalification shall include, but not be limited to, the following:

(1) evidence of successfully passing a current physical examination as defined in (a) above.

(2) satisfactory completion of a written examination covering operational characteristics, controls, power line avoidance, stability requirements, and emergency control skills, such as response to fire, power line contact, loss of stability, or control malfunctions appropriate to the material placement system for which they are being qualified.

(3) operators shall demonstrate their ability to read and comprehend the material placement system manufacturer's operation and maintenance instruction materials.

(4) completing an operations test demonstrating proficiency in handling the specific type material placement system on which they are being requalified, including both prestart and poststart inspections, setup procedures, maneuvering skills, shutdown, and securing procedures.

(5) operators shall demonstrate understanding of the applicable sections of the B30 Standard and federal, state, and local requirements.

(d) Trainee qualification requirements shall include, but not be limited to, the following:

(1) evidence of successfully passing a current physical examination as defined in (a) above.

(2) satisfactory completion of a written examination covering operational characteristics, controls, power line avoidance, stability requirements, and emergency control skills, such as response to fire, power line contact, loss of stability, or control malfunctions appropriate to the material placement system for which they are being qualified.

(3) operator trainees shall demonstrate their ability to read and comprehend the material placement system manufacturer's operation and maintenance instruction materials.

(e) Trainee qualification, operator qualification, and operator requalification shall be performed by a qualified person.

(f) Operator physical examinations shall be required every 3 yr or more frequently if supervision deems it necessary.

27-3.1.3 Responsibilities

(14)

While the organizational structure of various projects may differ, the following roles are described here for purposes of delineating responsibilities. All responsibilities listed below shall be assigned in the work site organization. All personnel designated to fulfill responsibilities in this section shall meet the competency requirements described in Section 27-0.4. (A single individual may perform one or more of these roles.) A material placement system is a concrete pump or mobile concrete conveyor.

liquid structural material supplier (typically a ready mixed concrete supplier): batches and supplies the material to the material placement system for delivery to the point of placement.

material placement system operator (pump operator): directly controls the material placement system's functions.

material placement system owner (pump owner): has custodial control of a material placement system by virtue of lease or ownership.

material placement system user: orders the material placement system's presence on a work site and controls its use there.

placing crew: personnel involved in placing and finishing the material delivered by the material placement system.

pour supervisor: directly oversees the work being performed by a material placement system and the associated placing crew.

site supervisor: exercises supervisory control over the work site on which a material placement system is being used and over the work that is being performed on that site.

27-3.1.3.1 Responsibilities of the Material Placement System Owner and Material Placement System User.

In some situations, the owner and user are the same entity and are therefore accountable for all of the following responsibilities. In other cases, the user may lease or rent a material placement system from the owner without supervisory, operational, maintenance, support personnel, or services from the owner. In those situations, paras. 27-3.1.3.1.1 and 27-3.1.3.1.2 shall apply.

27-3.1.3.1.1 The material placement system owner's responsibilities shall include the following:

(a) providing a material placement system that meets the requirements of Chapters 27-1 and 27-2, as well as specific job requirements defined by the user

(b) providing a material placement system and all necessary components, specified by the manufacturer, that meet the user's requested configuration and capacity

(c) providing additional technical information pertaining to the material placement system, necessary for



placement system operation, when requested by the material placement system user

(d) providing operation instructions, maintenance information, and warning decals and placards installed in the locations prescribed by the material placement system manufacturer

(e) establishing an inspection, testing, and maintenance program in accordance with Chapter 27-2 and informing the material placement system user of the requirements of this program

(f) using personnel that meet the requirements for competency as defined in Section 27-0.4, for inspection, testing, and maintenance as required in Chapter 27-2

(g) supplying delivery system, if part of the job scope, in adequate condition for the job requirements

(h) communicating to the site supervisor and pour supervisor any and all requirements for the assembly, disassembly, cleaning, storage, security, and inspection of the supplied delivery system

(i) communicating to the site supervisor and pour supervisor any expectations of obtaining prior approval before allowing any other entity to use the supplied delivery system

(j) verifying that any auxiliary equipment is available in working condition when the requirements for that equipment have been communicated by the material placement system owner to the material placement system user and the site supervisor

(k) communicating to the site supervisor and the pour supervisor the requirements of the discharge area, restraining devices, training, accessories, and procedures when using compressed air for cleaning

(l) ensuring that training for cleaning with compressed air has been completed for any operator who will be cleaning with compressed air

27-3.1.3.1.2 The material placement system user's responsibilities shall include the following:

(a) complying with the requirements of this Volume, manufacturer's requirements, and those regulations applicable at the work site

(b) using supervisors for material placement system activities that meet the requirements for a qualified person as defined in Section 27-0.2

(c) training the material placing crew in the recognition of and avoidance of hazards when working with and near a material placement system

(d) training personnel assigned to the pump in the recognition of and avoidance of hazards when working with and near a material placement system

(e) using material suppliers that have trained their personnel in the recognition and avoidance of hazards when working with and near material placement systems

(f) ensuring that the area for the material placement system is adequately prepared. The preparation includes, but is not limited to, the following:

(1) access roads for the material placement system, material delivery to the material placement system, and access for other associated equipment

(2) sufficient room to assemble and disassemble the material placement system

(3) an operating area that is suitable for the material placement system with respect to levelness, surface conditions, support capability, proximity to power lines, excavations, slopes, underground utilities, subsurface construction, and obstructions to material placement system operation

(4) traffic control as necessary to restrict unauthorized access to the material placement system's working area

(g) using material placement system operators who meet the requirements of paras. 27-3.1.1 and 27-3.1.2(f) and are qualified to perform the tasks that will be required with the material placement system to which they are assigned to operate

(h) informing the material placement system owner of the presence of power lines in the proximity of the work area, at the time of ordering

(i) ordering equipment and delivery system adequate for job requirements

(j) providing any auxiliary equipment as communicated by the material placement system owner

(k) ordering a mix that is compatible with the material placement system ordered

(l) ordering the delivery of perishable material in a sequence that will prevent blockages in the delivery system

27-3.1.3.2 Responsibilities of Site Supervisor and Pour Supervisor. In some situations, the site and pour supervisors may be the same person.

27-3.1.3.2.1 The site supervisor's responsibilities shall include the following:

(a) determining if site-specific regulations are applicable to material placement system operations

(b) ensuring that a qualified person is designated as the pour supervisor

(c) ensuring that material placement system operations are coordinated with other job-site activities that will be affected by or will affect placing operations

(d) ensuring that the area for the material placement system is adequately prepared. The preparation includes, but is not limited to, the following:

(1) access roads for the material placement system, material delivery to the material placement system, and access for other associated equipment

(2) sufficient room to assemble and disassemble the material placement system



an operating area that is suitable for the material placement system with respect to levelness, surface conditions, support capability, proximity to power lines, excavations, slopes, underground utilities, subsurface construction, and obstructions to material placement system operation

(4) traffic control as necessary to restrict unauthorized access to the material placement system's working area

(e) ensuring that material placement system operators meet the requirements of para. 27-3.1.2

(f) ensuring that conditions that may adversely affect material placement system operations are addressed. Such conditions include, but are not limited to, the following:

- (1) power line location
- (2) wind velocity or gusting winds
- (3) heavy rain
- (4) fog
- (5) extreme cold
- (6) darkness
- (7) lightning
- (8) poor soil conditions

(g) allowing material placement system operation near electric power lines only when the requirements of para. 27-3.1.6 have been met

(h) supplying the delivery system, if part of the job scope, in adequate condition for the job requirements

(i) ensuring that any delivery system left on the job for continuing use is in adequate condition for the job requirements

(j) performing any stated requirements for the assembly, disassembly, cleaning, storage, security, and inspection of the supplied delivery system

(k) obtaining prior approval to use a delivery system owned by another entity

(l) verifying that any auxiliary equipment is available in working condition, when the requirements for that equipment have been communicated by the material placement system owner

(m) satisfying the requirements of para. 27-3.1.3.1.1(l) when using compressed air for cleaning

(n) ordering a mix that is compatible with the material placement system ordered

(o) sequencing the delivery of perishable material to prevent blockages in the delivery system

(p) determining whether or not to add water to the material

27-3.1.3.2.2 The pour supervisor's responsibilities shall include the following:

(a) being present at the job site during placing operations

(b) allowing material placement system operation near electric power lines only when the requirements of

para. 27-3.1.6 and any additional requirements determined by the site supervisor have been met

(c) ensuring that the preparation of the area needed to support material placement systems has been completed before material placement system operations commence

(d) ensuring necessary traffic controls are in place to restrict unauthorized access to the material placement system's work area

(e) ensuring that personnel involved in material placement system operations understand their responsibilities, assigned duties, and the associated hazards

(f) addressing safety concerns raised by the operator or other personnel and being responsible if he decides to overrule those concerns and directs material placement system operations to continue (In all cases, the manufacturer's criteria for safe operation and the requirements of this Volume shall be adhered to.)

(g) appointing the signal person(s) and conveying that information to the material placement system operator and ensuring that signal person(s) appointed meet the requirements of Section 27-3.3

(h) stopping material placement system operations if alerted to an unsafe condition affecting those operations

(i) ensuring precautions are implemented when hazards associated with special placing operations are present. Such operations include, but are not limited to, the following:

- (1) working at underground job sites
- (2) placing in occupied buildings
- (3) pumping underwater
- (4) operating mobile material placement systems on barges
- (5) placing heavyweight concrete

(j) ensuring that any delivery system left on the job for continuing use is in adequate condition for the job requirements

(k) performing any stated requirements for the assembly, disassembly, cleaning, storage, security, and inspection of the supplied delivery system

(l) obtaining prior approval to use a delivery system owned by another entity

(m) verifying that any auxiliary equipment is available in working condition, when the requirements for that equipment have been communicated by the material placement system owner

(n) satisfying the requirements of para. 27-3.1.3.1.1(l) when using compressed air for cleaning

(o) verifying that the material delivered is the same as the material ordered

(p) verifying that perishable material on the job is within specified time constraints before unloading into the material placement system

(q) determining whether or not to add water to the material



ating a person to oversee the delivery of material to the hopper if the material placement system operator is required to operate away from the machine and verifying that the designated person knows the proper steps to be taken if air or foreign objects enter the hopper

27-3.1.3.3 Responsibilities of Material Placement System Operators. The operator shall be responsible for the following listed items. The operator shall not be responsible for hazards or conditions that are not under his direct control and that adversely affect the placement operations. Whenever the operator has doubt as to the safety of material placement system operations, the operator shall stop the material placement system's functions in a controlled manner. Placing operations shall resume only after safety concerns have been addressed.

27-3.1.3.3.1 The operator's responsibilities shall include the following:

- (a) reviewing the requirements for the placing job with the pour supervisor before operations.
- (b) knowing what types of site conditions could adversely affect the operation of the material placement system and consulting with the pour supervisor concerning the possible presence of those conditions.
- (c) understanding and applying the information contained in the material placement system manufacturer's operating manual.
- (d) understanding the material placement system's functions and limitations as well as its particular operating characteristics.
- (e) refusing to operate the material placement system when any portion of the material placement system would enter the danger zone of energized power lines, except as defined in para. 27-3.1.6.
- (f) performing a frequent inspection as specified in para. 27-2.1.2.
- (g) promptly reporting to a designated person the need for adjustments or repairs.
- (h) following applicable lockout/tagout procedures.
- (i) not operating the material placement system when physically or mentally unfit.
- (j) following procedures to ensure that the danger of hosewhipping is minimized.
- (k) not engaging in any practice that will divert attention while operating the material placement system controls.
- (l) testing the material placement system function controls prior to beginning operations and not proceeding if it creates a hazardous condition.
- (m) operating the material placement system's functions, under normal operating conditions, in a smooth and controlled manner.
- (n) knowing and following the procedures specified by the manufacturer or approved by a qualified person

for assembly, disassembly, and setting up the material placement system.

- (o) observing each outrigger during extension, setting, and retraction or using a signalperson to observe each outrigger during extension, setting, or retraction.
- (p) knowing the standard and special signals as specified in Section 27-3.3 and responding to such signals from the signalperson who is directing the machine operation. The operator shall obey a stop signal at all times, no matter who gives it.
- (q) before leaving the material placement system unattended, adhering to the manufacturer's recommendations for securing the unit.
- (r) not using a concrete delivery hose as an end hose unless an anti-hosewhipping device is properly installed.
- (s) complying with the training required by para. 27-3.1.3.1.1(l) when using compressed air for cleaning.
- (t) ensuring that any delivery system removed from the placing line is cleaned to prevent blockages.
- (u) knowing that the decision whether or not to add water to the material belongs only to the site supervisor or pour supervisor.
- (v) informing the pour supervisor of the proper steps to be taken if air or foreign material has entered the hopper.

27-3.1.3.4 Responsibilities of Liquid Structural Material Suppliers. The liquid structural material supplier (typically the ready-mixed concrete supplier) brings the material from the batch plant to the job site. They shall be responsible for the batching, transportation, quality of components, uniformity of components, and delivery into the material placement system. They are not responsible for the design of the mix, unless specifically asked to provide a design.

27-3.1.3.4.1 The liquid structural material supplier's responsibilities shall include the following:

- (a) providing a mix consisting of the material components specified
- (b) delivering the material according to the specified time criteria
- (c) training of the liquid structural material supplier drivers about the duties and hazards of working with material placement systems

27-3.1.3.4.2 The liquid structural material supplier driver's responsibilities shall include the following:

- (a) delivering material into the hopper at a rate sufficient to prevent air from being introduced into the material placement system
- (b) notifying the material placement system operator when their truck is empty or if air has entered the material placement system



ifying the material placement system operator
When material is discharged with the mix into the
operator
(d) activating the material placement system emergency stop if unable to communicate with the operator and air or foreign material has entered the hopper

27-3.1.3.5 Responsibilities of the Placing Crew.

The placing crew's responsibilities shall include the following:

- (a) remaining beyond the reach of the discharge hose(s) until directed otherwise by the material placement system operator
- (b) wearing personal protective equipment to protect against injury caused by material hazards
- (c) complying with the responsibilities, assigned duties, and avoidance of the associated hazards per para. 27-3.1.3.2.2(e)

27-3.1.4 Conduct of Operators

- (a) Operators shall operate the material placement system in accordance with the manufacturer's recommendations or, lacking such recommendations, as directed by a qualified person.
- (b) The operator shall not divert his attention from the operation of the material placement system while operating the material placement system.
- (c) When physically or mentally unfit, an operator shall not engage in the operation of equipment.
- (d) The operator shall respond to signals from the spotter. However, the operator shall obey a stop signal at all times, no matter who gives it.
- (e) Each operator shall be held responsible for those operations under the operator's direct control. If there is any doubt as to the safety of the situation, the operator shall consult with a qualified person before proceeding.
- (f) The operator shall not leave the machine controls unattended when the material placement system is operating.
- (g) The operator shall disable the material placement system according to the manufacturer's recommendations before leaving the material placement system controls unattended.
- (h) When site weather conditions exceed the manufacturer's operating parameters, the manufacturer's recommendations for securing the material placement system shall be followed.
- (i) The operator shall be familiar with the equipment and its proper care. The operator shall promptly report the need for adjustments or repairs or potentially hazardous conditions to a designated person and also notify the next operator.
- (j) All controls shall be tested by the operator at the start of a new shift. If any controls fail to operate properly, which could create a hazardous condition, they

shall be adjusted or repaired before operations are begun.

(k) The manufacturer's boom assembly and disassembly procedures shall be followed. In the absence of such procedures, the directions of a qualified person shall be followed.

(l) When removing pins or bolts from a detachable boom, workers should stay out from under the boom.

(m) Each outrigger shall be visible to the operator or a spotter during extension, slewing, or jacking.

(n) The operator shall not set up or operate the material placement system when it results in a hazardous condition.

27-3.1.5 Operating Practices

Material placement systems shall

- (a) not be used as cranes or hoists to lift objects or other loads
- (b) not be overloaded by
 - (1) hanging system pipe or hose beyond the specification of the manufacturer
 - (2) installing boom pipe, elbows, or clamps heavier than manufacturer's specifications
 - (3) attaching pipeline directly to the boom tip elbow without a flexible delivery hose that allows boom movement
 - (4) securing the boom to any fixed object
- (c) be set up level according to the manufacturer's specification
- (d) be operated with all outriggers fully slewed, extended, and jacked level in accordance with the manufacturer's procedures. Shorttrigging is permitted only if all the following conditions are met:
 - (1) It is documented by a qualified person that shorttrigging is unavoidable.
 - (2) The boom is not operated beyond the area of fully extended outriggers (see Fig. 27-3.1.5-1).
 - (3) Any outriggers left retracted are jacked and the unit leveled.
 - (4) The manufacturer's or a qualified person's documented procedures are followed.
- (e) not be used to drag hose or separately laid delivery system
- (f) not be operated without a sling or cable attaching each piece of hanging delivery system to the boom
- (g) not be moved to different locations unless both the boom and outriggers are stowed in the transport position or as directed by the manufacturer's specification
- (h) not be operated when lightning is present
- (i) not be operated when wind force exceeds the manufacturer's recommendation for safe operation
- (j) not be transported at more than 10 mi/hr unless the boom tie-down strap, if originally equipped, is utilized

(14)

Fig. 27-3.1.5-1 Area of Extended Outriggers

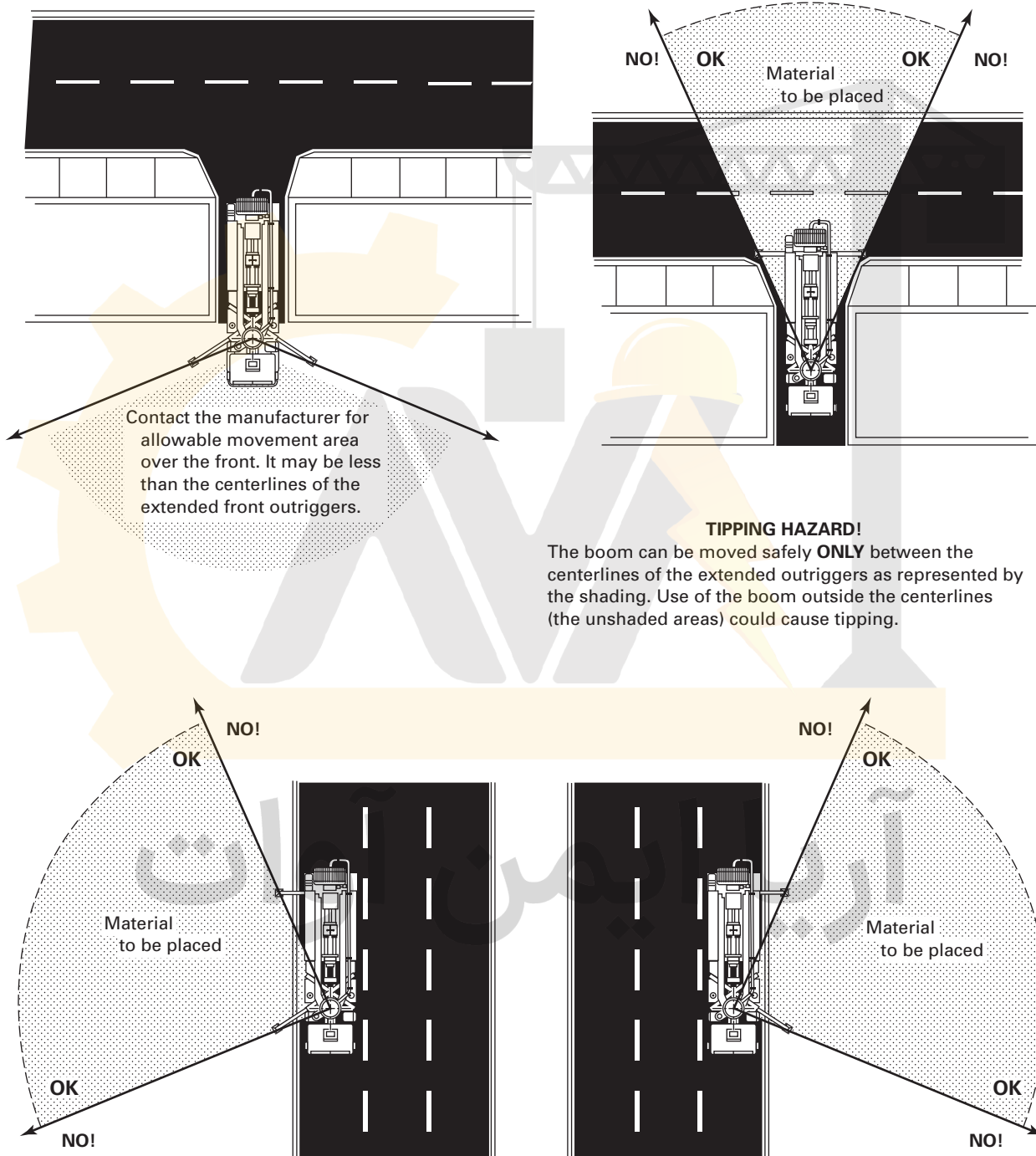



...y be set up when a combination of supplied ...er pads and, if needed, timbers, cribbing, or other ...ural members distribute the load of the outriggers so as not to exceed the allowable bearing capacity of the underlying material

(14) 27-3.1.6 Operating of Boom or Conveyor Near Electric Power Lines

27-3.1.6.1 Material placement systems shall not be operated near energized electrical power lines unless no combination of boom, delivery system, or machine components could enter the danger zone as shown in Fig. 27-3.1.6.1-1.

27-3.1.6.2 In the event operating within the danger zone is unavoidable, the following steps shall first be taken to ensure de-energization of the power lines:

- (a) The electrical utility or owner of the power lines shall de-energize the lines.
- (b) The lines shall be visibly grounded and appropriately marked at the job site location.
- (c) A qualified representative of the owner of the power line or a designated representative of the electrical utility shall verify that steps (a) and (b) above have been completed and the lines are not energized.

27-3.1.6.3 If a material placement system is positioned so the placing boom is capable of entering the danger zone, a spotter shall be appointed whose sole responsibility is to verify the clearances established in Table 27-3.1.6.3-1 are maintained and shall have the ability to alert the operator.

27-3.1.6.4 Any overhead wire shall be considered to be an energized line unless and until the person owning such line or the electrical utility authorities indicate it is not an energized line. Caution shall be exercised when working near overhead lines, because they can move horizontally or vertically due to wind, moving the danger zone to new positions. Operators shall not rely on the coverings of wires for their protection.

Prior to operating near energized electric power lines (excluding extension cords, power cables to equipment, insulated lighting feeds, or wires not accessible by the boom or conveyor because of location in a building, covering by conduit, or buried in the earth), determine whether any part of the material placement system or any part of its hanging components could get within

- 20 ft (6.1 m) of lines rated between 0.1 kV and 350 kV or
- 50 ft (15.25 m) of lines rated above 350 kV

If so, one of the following steps shall be taken:

- (a) Verify that the power lines have been de-energized and visibly grounded in accordance with the provisions of 27-3.1.6.2.
- (b) Maintain a 20-ft clearance (for power lines rated at 350 kV or less) or a 50-ft clearance (for power lines

rated above 350 kV) from the danger zone as shown in Fig. 27-3.1.6.1-1.

(c) Maintain the distances shown in Table 27-3.1.6.3-1 if a planning meeting with the appropriate personnel has been conducted prior to the operation. Appropriate personnel will vary according to circumstances but will always include the operator, the pour supervisor, the spotter, and any personnel who would touch the delivery system while the boom is in near proximity to the power lines.

27-3.1.6.5 In transit with the boom lowered, the clearance shall be as specified in Table 27-3.1.6.3-1 and illustrated in Fig. 27-3.1.6.1-1.

27-3.1.7 Cleaning Pipeline

27-3.1.7.1 Cleaning the boom pipeline should be accomplished by sucking a sponge ball backwards through the delivery pipeline per the manufacturer's specifications. Unless specified by the manufacturer, material delivery systems shall not be cleaned out with compressed air and then only when all of the following conditions have been met:

- (a) The operation is planned and supervised by a qualified person.
- (b) The system to be cleaned has been secured against movement.
- (c) All hoses at the discharge end have been removed, except when a short hose is part of a planned discharge into a ready mix truck.
- (d) The discharge is controlled.

27-3.1.7.2 Compressed Air Compressed air shall not be used to remove a blockage in a material delivery system.

27-3.1.8 Knowledge of Manual Content

Personnel responsible for the supervision, installation, operation, inspection, or maintenance of the material placement system shall be familiar with the applicable contents of the manual(s) supplied by the manufacturer.

SECTION 27-3.2: MATERIAL PLACEMENT SYSTEM LOCKOUT/TAGOUT

(a) A lockout/tagout policy and procedure shall be developed, documented, and implemented by the owner or user of the material placement system.

(b) The lockout/tagout policy and procedure shall comply with the requirements of ANSI Z244.1.

(c) The policy shall give consideration to the following areas:

- (1) material placement system power disconnection means
- (2) work to be done on the material placement system

Fig. 27-3.1.6.1-1 Danger Zone for Material Placement Systems and Delivery System Operating Near Electrical Transmission Lines

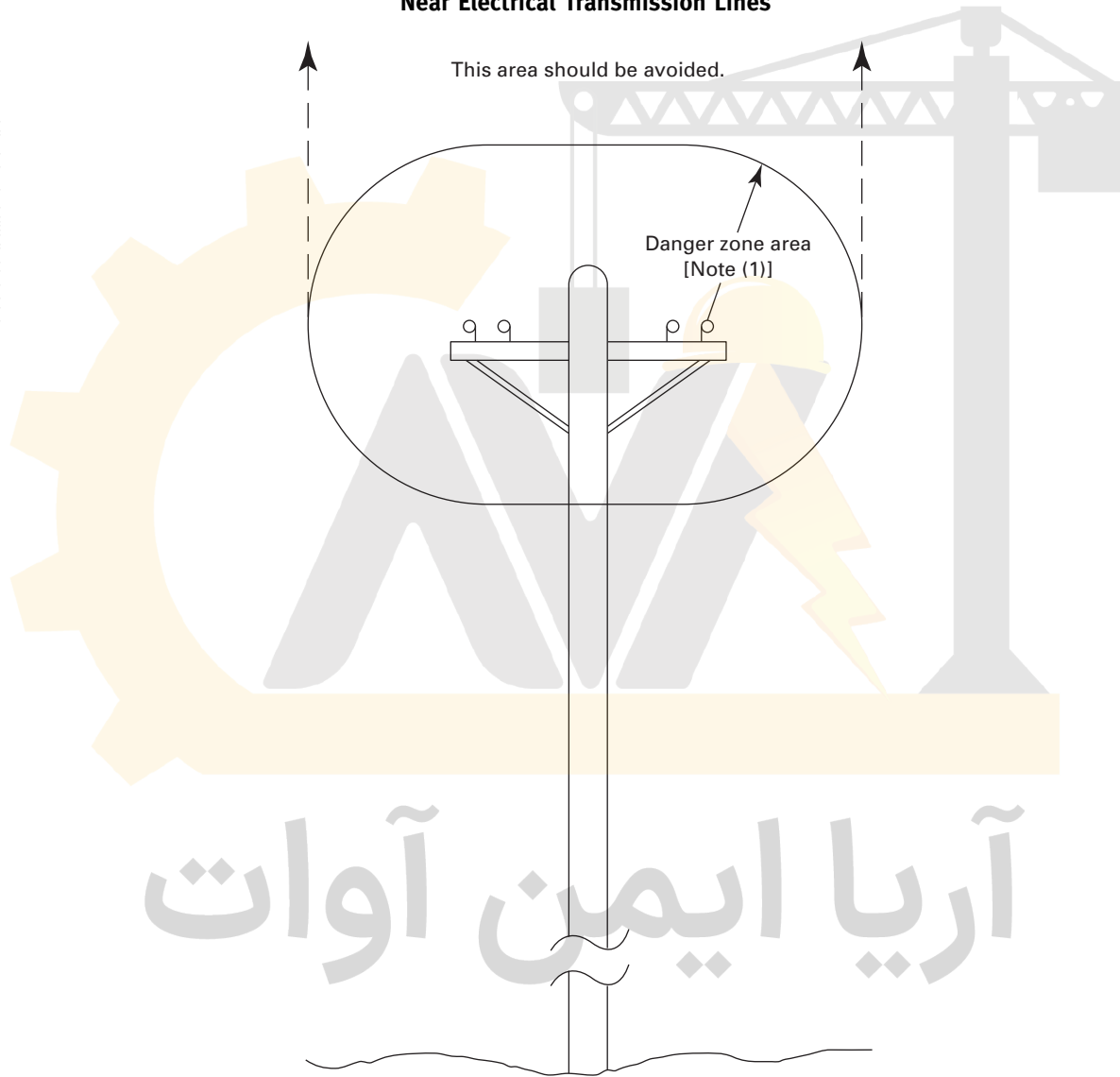

NOTE:

(1) For minimum radial distance of danger zone, see Table 27-3.1.6.3-1.

27-3.3: SIGNALS

27-3.3.1 Standard Signals

Standard signals to the operator shall be in accordance with para. 27-3.3.2 unless voice communication equipment (telephone, radio, or equivalent) is utilized. Signals shall be discernible or audible at all times. No response shall be made unless signals are clearly understood.

27-3.3.2 Hand Signals Hand signals shall be in accordance with Fig. 27-3.3.2-1.

27-3.3.3 Special Signals For operations not covered by para. 27-3.3.2, or for special conditions that occur from time to time, additions to or modifications of the standard signals or hand signals may be required. In all such cases, these special signals shall be agreed upon in advance by both the operator and designated spotter and should not be in conflict with standard signals.

27-3.3.4 Instructions

If it is necessary to give instructions to the operator other than those provided by established signal system, the material placement system movements shall be stopped.

Table 27-3.1.6.3-1 Minimum Required Clearances (14)

Normal Voltage, kV (Phase to Phase)	Minimum Required Clearance, ft (m) [Note (1)]
Operation Near Energized Power Lines	
0.1 to 50	10 (3)
Over 50 to 200	15 (4.50)
Over 200 to 350	20 (6.10)
Over 350 to 500	25 (7.62)
Over 500 to 750	35 (10.67)
Over 750 to 1 000	45 (13.72)
Over 1 000	As established by the line owner
Operation in Transit With Boom or Conveyor Lowered for Travel	
To 0.75	4 (1.22)
Over 0.75 to 50	6 (1.83)
Over 50 to 345	10 (3.05)
Over 345 to 750	16 (4.87)
Over 750 to 1 000	20 (6.10)

NOTE:

(1) Environmental conditions, such as fog, smoke, or precipitation, may require increased clearances.

Fig. 27-3.3.2-1 Material Placement System Hand Signals

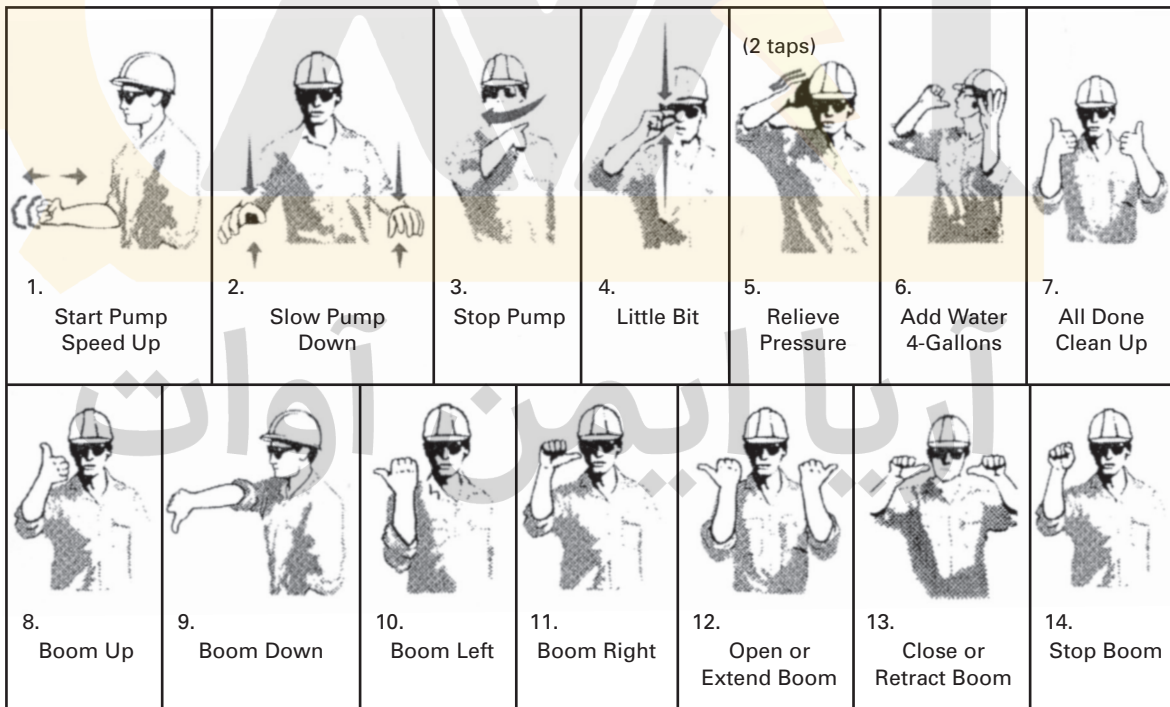

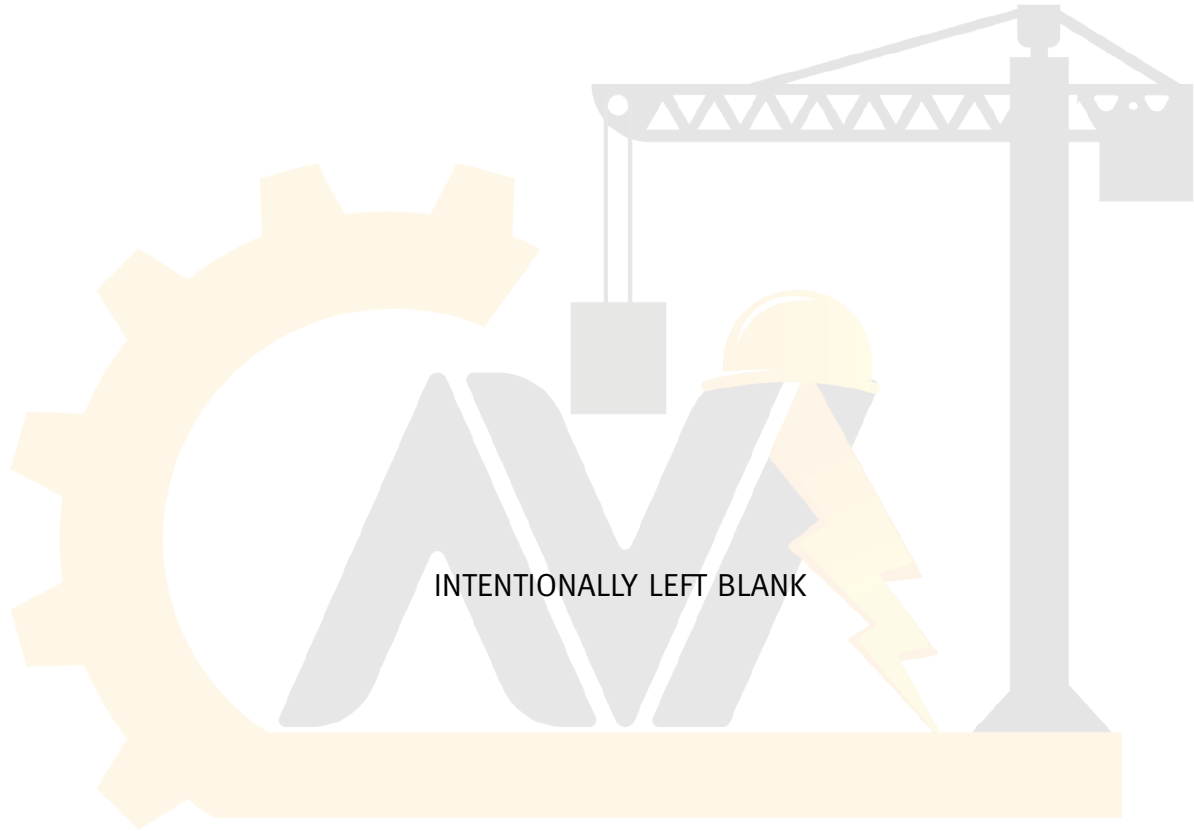

آریا ایمن آوات



INTENTIONALLY LEFT BLANK

آریا ایمن آوات



30.27-2014

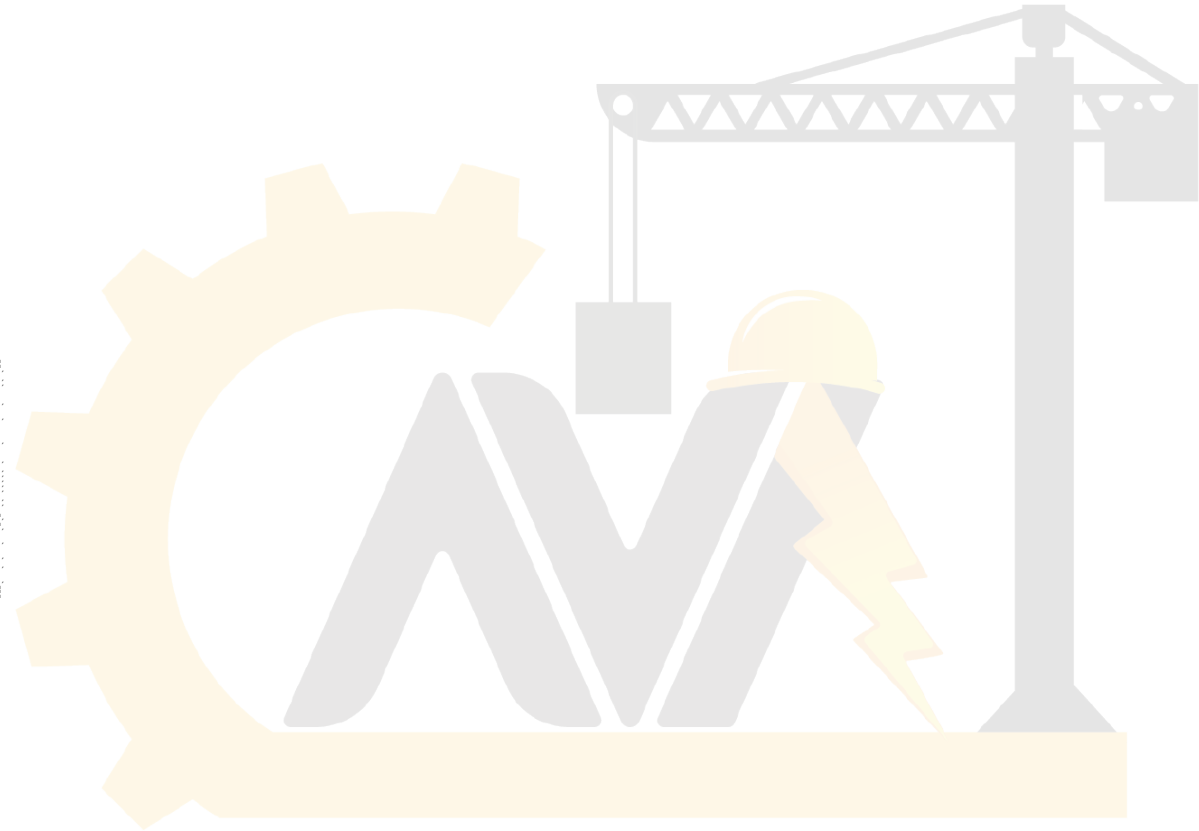

آریا ایمن آوات

ISBN 978-0-7918-6918-5



9 780791 869185



J17414