



A Guide to Cranes and Derricks



NCDOL

N.C. Department of Labor

آریا ایمن اوات

N.C. Department of Labor
Occupational Safety and Health Division
1101 Mail Service Center
Raleigh, NC 27699-1101

Cherie Berry
Commissioner of Labor

**N.C. Department of Labor
Occupational Safety and Health Program**

Cherie Berry
Commissioner of Labor
OSHA State Plan Designee

Allen McNeely
Deputy Commissioner for Safety and Health

Kevin Beauregard
Assistant Deputy Commissioner for Safety and Health

Bobby Davis
Reviewer

Acknowledgments

A Guide to Cranes and Derricks was originally prepared by David V. MacCollum, president of David V. MacCollum, Ltd., of Sierra Vista, Ariz. NCDOL recognizes with much appreciation the contributing organizations that offered and supplied material and information used in this guide. *Wire Rope Slings Pocket Reference Guide* extracts shown in the PDF version of this document are provided on behalf of union ironworkers and their employers by the Institute of the Ironworking Industry. Figures 14 and 15 were provided courtesy of Award Services Crane Safety Systems, a division of Ronald M. Ward & Associates Inc. of Orlando, Fla. N.C. Department of Labor employee Bobby Davis incorporated these documents into this guide, including information from the U.S. Department of Energy (DOE) Hoisting and Rigging Standard, DOE-STD-1090-2001 www.hss.doe.gov/nuclearsafety/ns/techstds/standard/standard.html#1001. DOE's current Hoisting and Rigging Standard, DOE-STD-1090-2007, can be found at www.hss.doe.gov/nuclearsafety/ns/techstds/standard/std1090-07/index.html. This guide was updated in 2010.

This guide is intended to be consistent with all existing OSHA standards; therefore, if an area is considered by the reader to be inconsistent with a standard, then the OSHA standard should be followed.

To obtain additional copies of this guide, or if you have questions about North Carolina occupational safety and health standards or rules, please contact:

**N.C. Department of Labor
Education, Training and Technical Assistance Bureau
1101 Mail Service Center
Raleigh, NC 27699-1101**

Phone: (919) 807-2875 or 1-800-NC-LABOR

Additional sources of information are listed on the inside back cover of this guide.

The projected cost of the NCDOL OSH program for federal fiscal year 2010–2011 is \$18,011,652. Federal funding provides approximately 31 percent (\$5,501,500) of this fund.



Contents

Part	Page
Foreword	iv
1 Reasons for Crane Accidents and Preventive Measures	1
2 Types of Cranes Generally Used in the Workplace	4
3 Analysis of Eight Hazards Common to Most Cranes	9
4 Crane Safety Programs	23
References, Requirements and Standards	28

آریا ایمن آوات

Foreword

Construction cranes are a common sight on North Carolina city skylines. People watch in amazement as stacks of material and loads of concrete become our newest buildings. But the very power and size of cranes can pose many dangers to the employees who work in and around them.

A Guide to Cranes and Derricks examines the hazards and describes safety measures the reader can take when implementing a crane safety program for a company. The guide also includes the new standards for cranes in North Carolina.

In North Carolina, N.C. Department of Labor enforces the federal Occupational Safety and Health Act through a state plan approved by the U.S. Department of Labor. NCDOL offers many educational programs to the public and produces publications to help inform people about their rights and responsibilities regarding occupational safety and health.

When reading this guide, please remember the mission of the N.C. Department of Labor is greater than just regulatory enforcement. An equally important goal is to help citizens find ways to create safe and healthy workplaces. Everyone profits when managers and employees work together for safety. This booklet, like the other educational materials produced by the N.C. Department of Labor, can help.

Cherie Berry
Commissioner of Labor

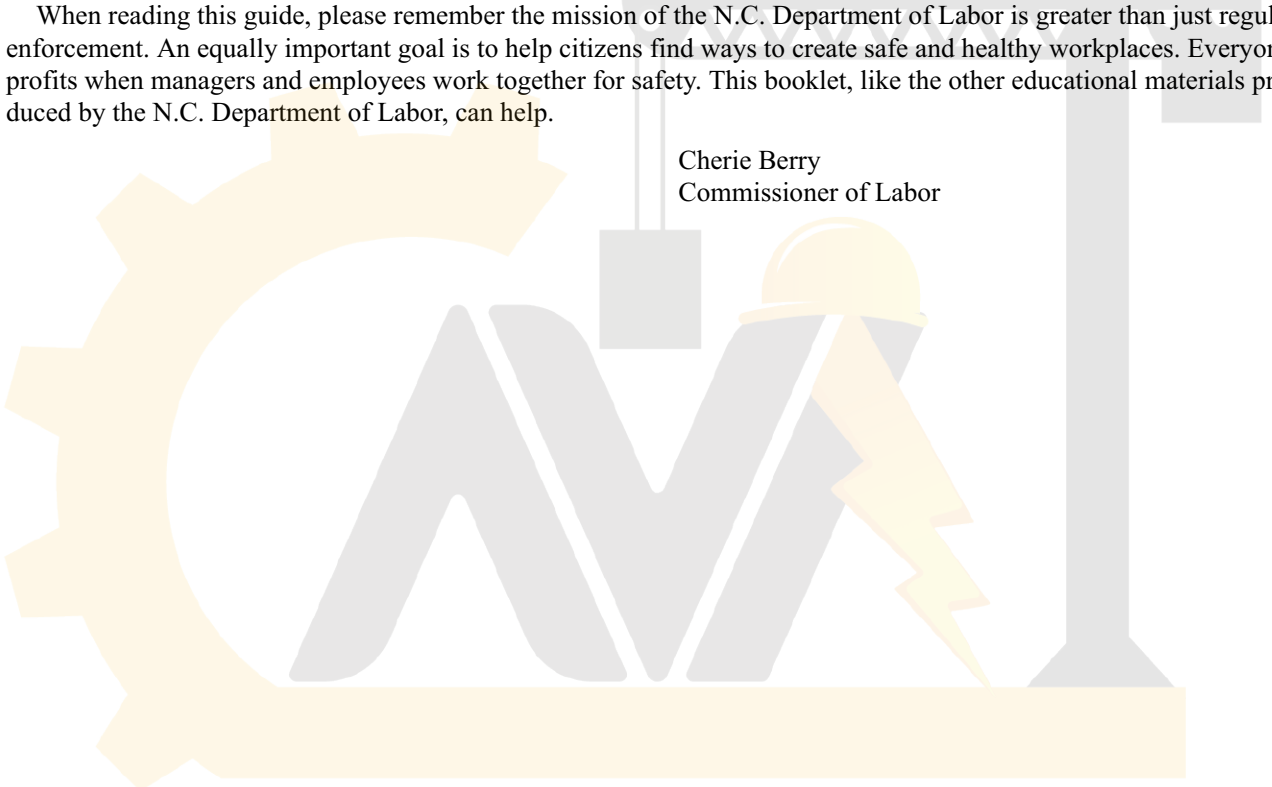

آریا ایمن آوات

Reasons for Crane Accidents and Preventive Measures

In our highly mechanized world, cranes are the workhorses that have increased productivity and economic growth in construction, mining, logging, maritime operations, and maintenance of production and service facilities. It is not unusual in large metropolitan areas to see several crane booms outlined against the skyline within a few blocks of each other and in rural areas to see cranes performing a great variety of jobs.

Statistics show, however, that there are inherent hazards that occur during normal working circumstances. A crane can be a very dangerous piece of equipment. Most crippling injuries and deaths from crane accidents can be attributed to several basic hazards.

Those supervising the use of cranes can greatly improve workplace safety by targeting the craning hazards that cause the most injury and death. Basic hazard prevention measures can be taken to eliminate these hazards. It is important to ensure the safety of all personnel who may be in the immediate areas where cranes are being operated, not just the riggers, signalers and operators.

Workplace safety is more than complying with a few safety rules. Everyone must be involved—management, supervisors and the work crew. Each has specific safety responsibilities, and a mutual understanding of who is responsible for what is essential. A fact that is often overlooked is that hazards are the primary cause of most accidents, so hazard prevention is what brings about a safe workplace. But, what is a hazard? How can a hazard be controlled?

As it relates to cranes, a hazard may be thought of as any unsafe condition. Hazards may be present in three forms:

- **Dormant:** A dormant hazard is an undetected hazard created either by design or crane use.
- **Armed:** An armed hazard is a dormant hazard that has become armed and ready to cause harm during certain work circumstances.
- **Active:** An active hazard is an armed hazard triggered into action by the right combination of factors. At this point it is too late to take any preventive action to escape injury or avoid death.

To change the design of a crane on a jobsite to make it safer is almost impossible, but there are measures within the control of every crane owner or user that can be taken to prevent a hazard from becoming armed and active. In decreasing order of importance, the most effective ways to control hazards are:

1. *Eliminate or minimize the hazard.* The major effort during the planning phase of any project must be to select appropriate work methods for cranes to eliminate hazards created by particular work circumstances.
2. *Guard the hazard.* Hazards that cannot be totally eliminated through planning must be reduced to an acceptable level of risk by the use of appropriate safety devices to guard, isolate or otherwise render the hazard effectively inert or inaccessible. If this cannot be done, then nearby personnel should be protected from the hazard. For example, the employer should ask the manufacturer to assist in installing guards to provide physical protection against moving parts. Listed below are other methods of guarding particular hazards or the danger zone they create.
 - a. Install screens or covers over moving parts.
 - b. To prevent electrocution when cranes are to be used in the vicinity of overhead energized power lines, have the local electric utility install line guards or covers on the lines. Use an insulated link on the hoist line to prevent the passage of electric current from the hook through the load to the person guiding the load on the ground.
 - c. Install fences, guardrails or other barriers to prevent entry into the danger zone created by the rotating crane cab.
 - d. Ask the manufacturer to install a crush-resistant cab and restraint system that encloses the operator in a protective frame to give the operator a place of safety if upset occurs.
3. *Give warning.* When a hazard cannot be controlled by applying either the first or second method, an active, intercessory warning device should be installed that detects a hazard and emits a timely, audible and/or visual warning signal. Examples are alarms, horns and flashing lights. Warning systems must emit the standard variety of sounds or flashes so the meaning of the warning will be understood. Some hazard detection systems not only give audible or visual warnings but are wired to stop or prohibit movement. On cranes, this is especially important so the boom can be stopped before it reaches a hazardous position. There are numerous suppliers of such items.

Signs and labels are passive warnings. They must be very explicit and state what the hazard is, what harm will result, and how to avoid the hazard. The signs for life-threatening hazards should be pictorial if possible, with the word DANGER written in white letters on an oval red background with a black border. Signs and labels are not substitutes for eliminating or guarding the hazard. Rather, warnings are best used to make users aware of a specific change of circumstances that can create a hazardous situation or of a dormant hazard that could not be totally eliminated or controlled. Warnings should also inform users as to why the specified safeguard must be used.

Requirements for signs and labels are set forth in Occupational Safety and Health Administration (OSHA) standards, "Specifications for Accident Prevention Signs and Tags," 29 CFR 1910.145; "Signs, Signals, and Barricades," 29 CFR 1926.200; and Society of Automotive Engineers Recommended Practices (SAE) J115, "Safety Signs."

4. *Special procedures and training.* When a hazard cannot be eliminated or its risk reduced by any of the first three methods, then planning, special operating procedures, training and audits must be employed to guarantee that a viable, continuing regimen will effect avoidance of the hazard.

5. *Personal protective equipment.* Use of gloves, taglines to guide the load, hard hats, safety shoes, aprons, goggles, safety glasses, lifelines, life jackets and other protective equipment at all appropriate times will also protect users from injury.

Often a combination of several of these five preventive measures is necessary to control a life-threatening hazard.

In light of all the tower crane fatalities in the news during recent years, as well as a high number of other crane related fatalities and accidents North Carolina has experienced, it is important that NCDOL be proactive in taking action to address safety concerns and work to prevent further incidents. Therefore, inspection of tower and mobile crane operation is now added to our Special Emphasis Program referenced in Operational Procedures Notice (OPN) 123H. This will be an ongoing effort for inspection of mobile cranes, tower cranes and derricks at job or work sites throughout the state. The primary focus will be to increase crane inspection activity, training and outreach efforts, and consultative services in this area. All counties are included in this part of the construction emphasis program. Compliance officers are directed to stop and conduct inspection activity whenever they see a crane in use (consultation can also stop and offer services).

Mobile cranes include truck-mounted cranes, crawler cranes, locomotive cranes, wheel-mounted cranes and articulating boom cranes. Tower cranes include hammerhead tower cranes, fixed tower cranes, climber tower cranes, luffing boom tower cranes, self-erector tower cranes and mobile tower cranes.

Compliance inspections will ensure that the operator is adequately trained, the employer/operator are following OSHA and ANSI requirements for the particular crane they are operating, cranes have been inspected prior to service and on a daily basis per ANSI and OSHA standards, the crane and operation thereof are in good repair, cranes are receiving required preventative maintenance, and that proper documentation is maintained by the employer.

The table below presents a summary of North Carolina crane-related accidents for June 1998–June 2007. (Reports indicate date, standard industrial classification (SIC), employee type and age.)

Table 1
North Carolina crane-related accidents

Date	SIC	Accident Description	Employee Type	Employee Age
03/27/07	1791	Crushed by crane	Laborer	25
01/30/06	1622	Struck by crane boom	Laborer	48
12/01/05	5084	Crushed by two cranes	Laborer	48
05/07/04	1799	Struck by crane	Rigger/operator	33
09/16/02	1791	Crushed by falling crane	Laborer	30
08/01/01	3443	Fall from crane collapse	Laborer	20
08/01/01	3443	Fall from crane collapse	Laborer	37
03/23/00	1791	Struck by loose crane boom	Tower erector	26
05/04/00	1791	Struck by crane	Construction worker	34
06/29/98	3441	Struck by falling steel from crane	Material Handler	59

National Injury Data

The Census of Fatal Occupational Injuries (CFOI) is a multisource data system maintained by the U.S. Bureau of Labor Statistics (BLS) to identify work-related deaths in the United States. A NIOSH review of CFOI data identified 719 cases between 1992 and 2002 in which a mobile crane[†] was the primary or secondary source of a fatal injury [NIOSH 2004]. Incidents in which the victim was struck by an object such as an uncontrolled hoisted load or part(s) of a mobile crane accounted for 290 (40.3 percent) of these fatalities (Table 2). Electrocution fatalities due to cranes contacting overhead power lines or other electrical sources accounted for 173 (24.1 percent) of the 719 CFOI cases. A previous NIOSH alert [NIOSH 1995] addressed crane-related electrocution hazards. This alert primarily addresses injuries and deaths when workers are struck by falling or swinging objects resulting from crane stability issues related to tip-over, boom collapse, and uncontrolled hoisted loads. According to CFOI data, 153 (52.8 percent) of 290 mobile crane-related fatalities in which the victim was struck by an object (such as an uncontrolled hoisted load or crane part) occurred in construction. Forty-four (15 percent) occurred in manufacturing (Table 3).

Table 2

Events resulting in mobile crane-related occupational injury deaths: United States, 1992–2002

	Number of deaths	Percent
Struck by falling or swinging object (e.g., crane part or hoisted load)	290	40.3
Contact with electrical current (e.g., overhead power lines)	173	24.1
Fall from crane structure or cab	88	12.2
Transportation (e.g., moving crane from site to site)	76	10.6
Caught in crane moving parts	73	10.2
Other	19	2.6
Total	719	100.0

Table 3

Struck by mobile crane-related occupational injury deaths by industry: United States, 1992–2002

	Number of deaths	Percent
Construction	153	52.8
Manufacturing	44	15.2
Transportation and public utilities	35	12.0
Services	20	6.9
Wholesale trade	14	4.8
Mining	12	4.1
Agriculture, forestry, and fishing	6	2.1
Other	6	2.1
Total	290	100.0

[†]The following occupational injury and illness source codes for cranes were included: unspecified (3430); floating (3431); hammerhead (3433); mobile, truck, and rail mounted (3434); portal, tower, and pillar (3437); and N.E.C. (3439). These specific codes were selected to limit the analysis to types of mobile cranes. Excluded crane types include gantry (3432); monorail and underhung (3435); overhead (3436); and storage and retrieval hoist systems (3438).

Types of Cranes Generally Used in the Workplace

Rough Terrain and Wheel-Mounted Telescoping Boom

Figure 1

Wheel-Mounted Crane—Telescoping Boom (Single Control Station)

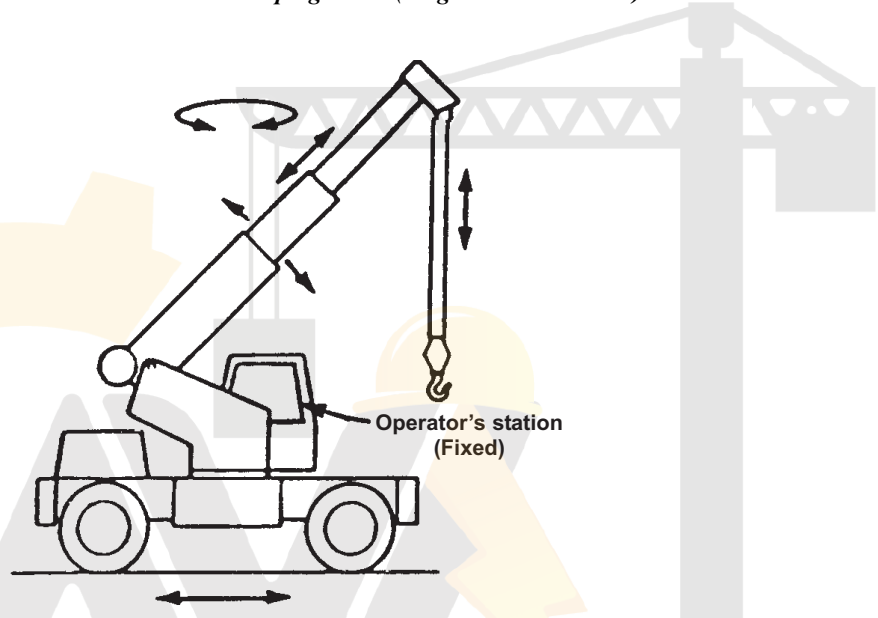

Hydraulic Boom

Figure 2

Wheel-Mounted Crane—Telescoping Boom (Multiple Control Station)

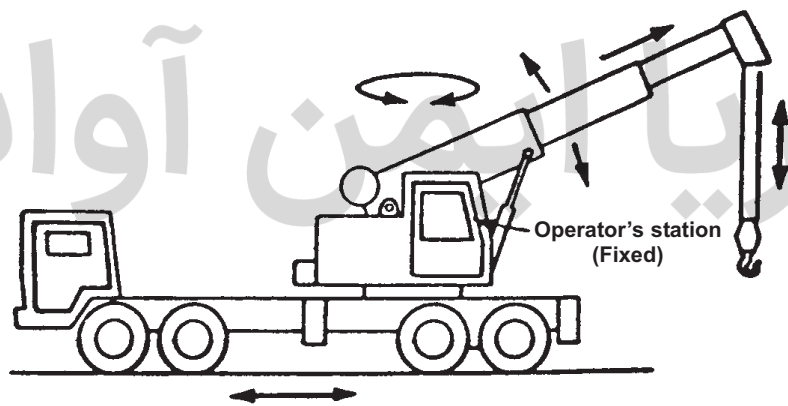

Latticework Boom

Figure 3

Wheel-Mounted Crane (Multiple Control Station)

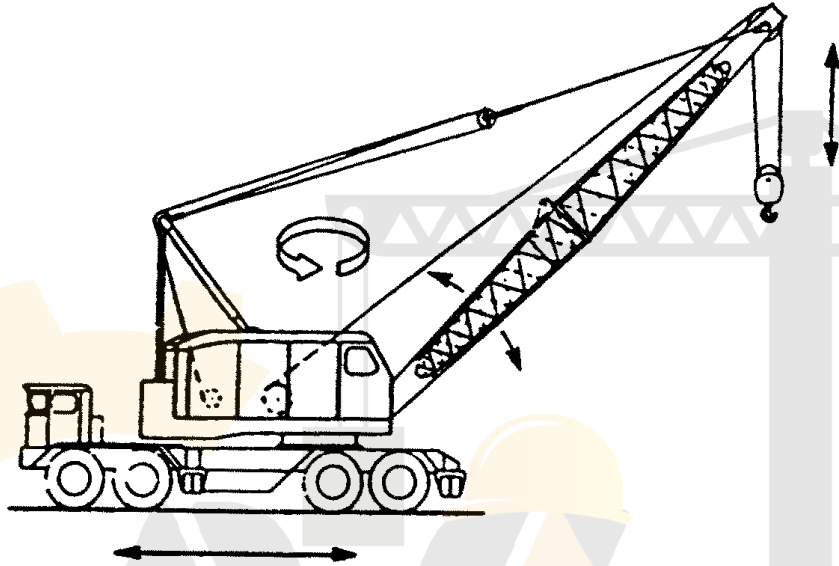

Hydraulic Boom

Figure 4

Commercial Truck-Mounted Crane—Telescoping Boom

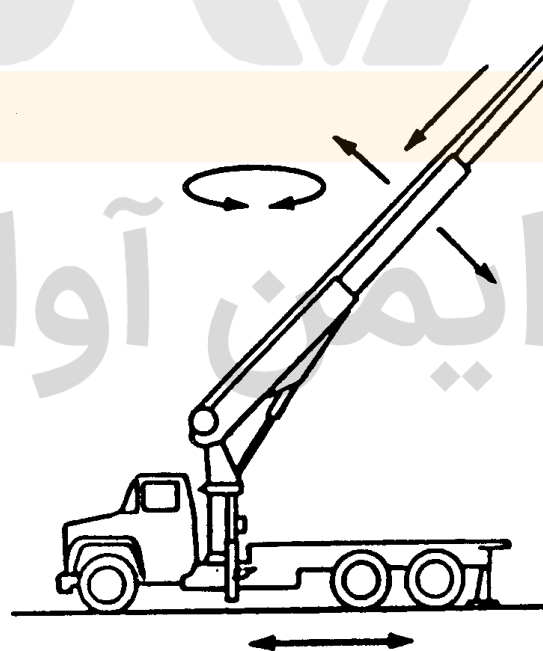

Tower Crane

Figure 5

Hammerhead

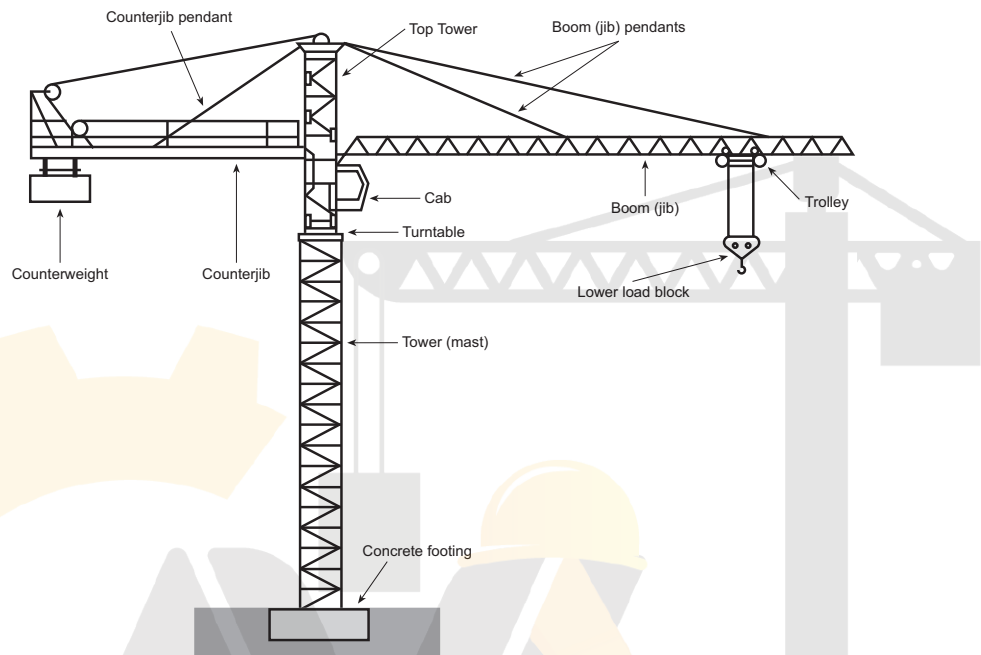

Tower Crane

Figure 6

Luffing Boom

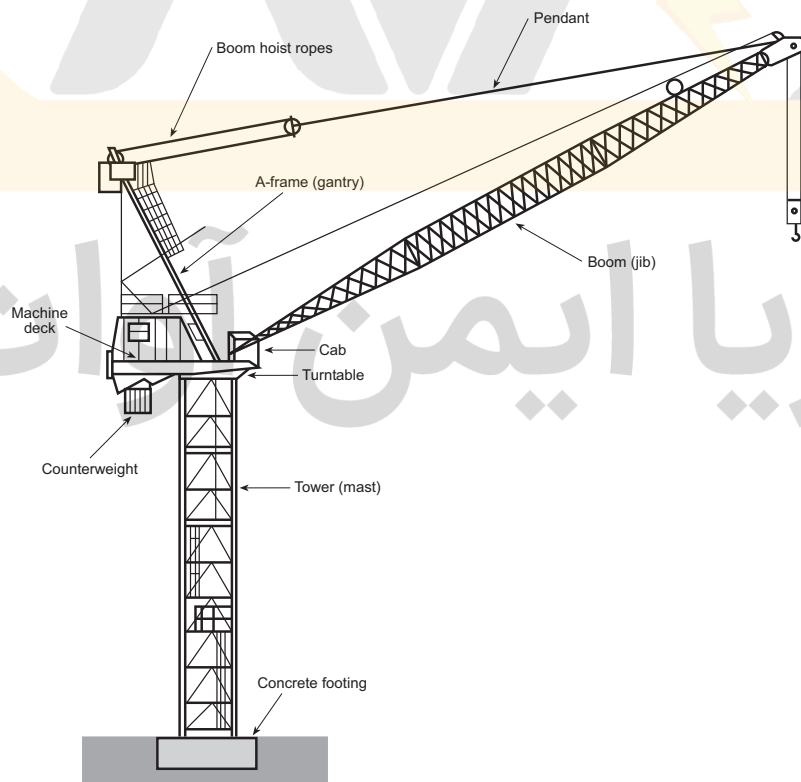

Articulated Boom

Figure 7

Commercial Truck-Mounted Remote Control

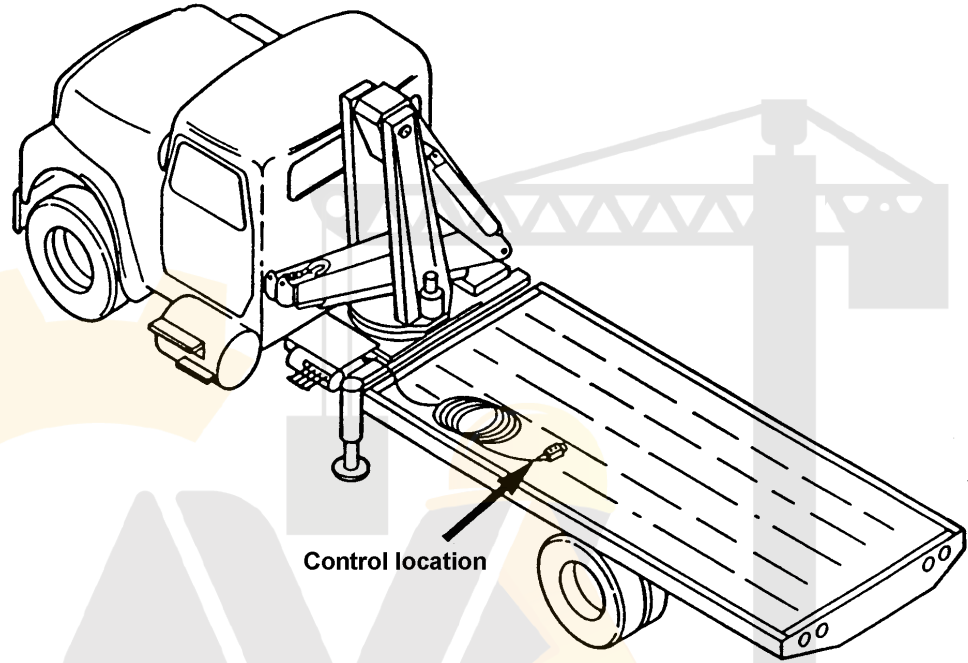

Trolley Boom

Figure 8

Trolley Boom Crane

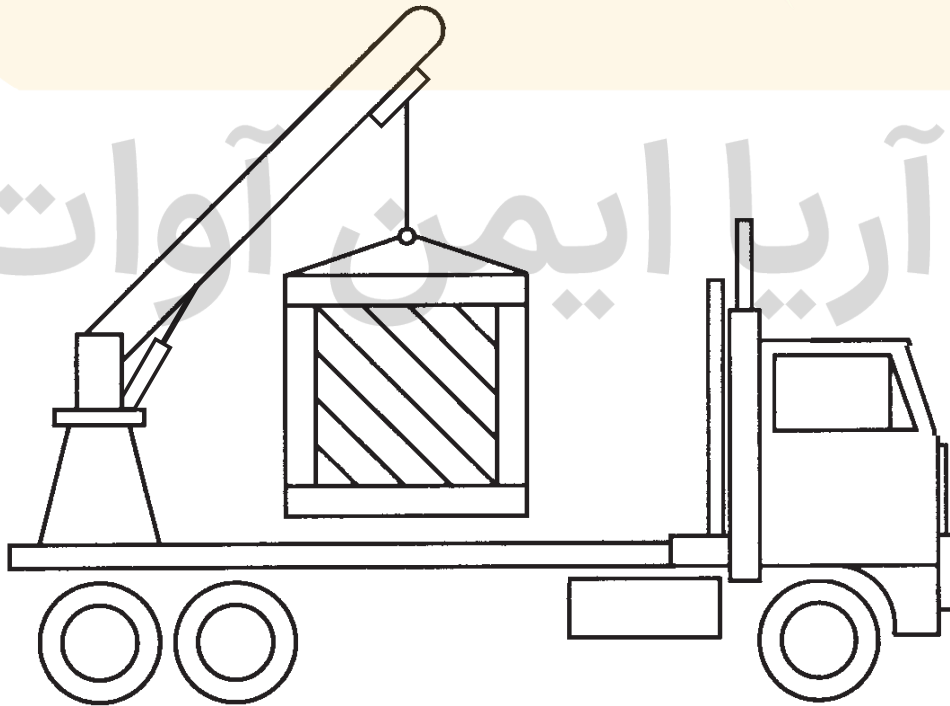

Crawler-Mounted Latticework Boom Cranes

Figure 9

Crawler Crane

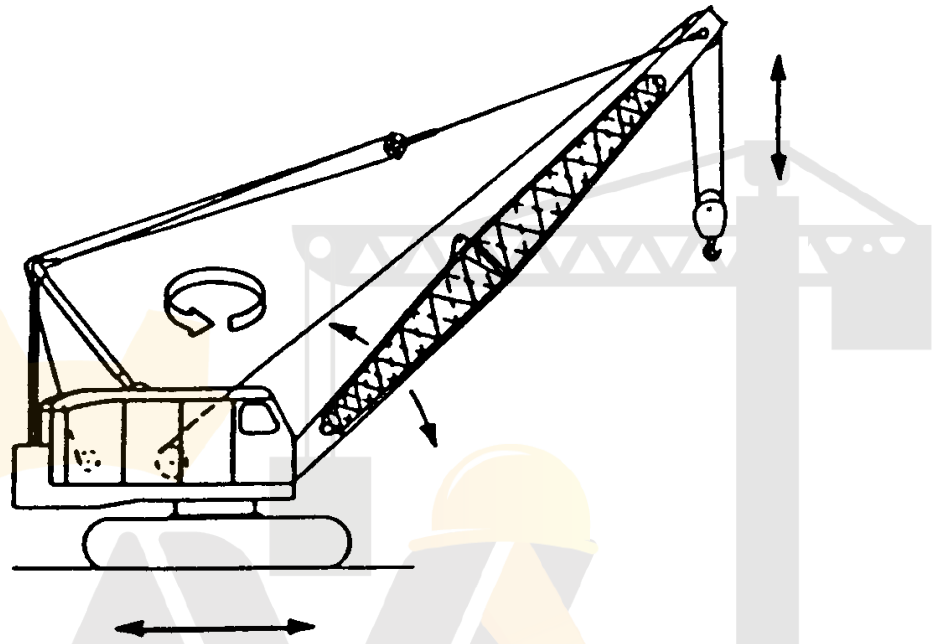

آریا ایمن آوات

3

Analysis of Eight Hazards Common to Most Cranes

This part analyzes eight hazards common to most cranes. Each analysis includes a definition, description, risks presented by the hazard, reasons why the hazard occurs, preventive measures and any applicable OSHA requirements.

The lack of qualifications on the part of crane operators figures prominently into these hazards. The crane owner and job supervisor must ensure that their crane operators are qualified and competent, not only in machine operations but in load capacity calculations as well. Minimum competent personnel requirements are included in Part 4.

Power Line Contact

Definition

Power line contact is the inadvertent contact of any metal part of a crane with a high-voltage power line.

Description

Most power line contacts occur when a crane is moving materials adjacent to or under energized power lines and the hoist line or boom touches a power line. Contact also frequently occurs during pick-and-carry operations when loads are being transported under energized power lines. Sometimes the person who is electrocuted is touching the crane or getting on or off of it when the hoist line or boom inadvertently comes into contact with an energized power line.

In some circumstances, when a crane comes into contact with a power line and sufficient ground fault is created, the electric utility's distribution system is automatically deenergized by a reclosure switch to avoid the blowing of intervening fuses. Many times people assume that the power line is deenergized when the sparks stop at the point of contact. But this can be very misleading, because the circuit is automatically reenergized several seconds later, so there usually is not enough time given by this type of deenergization to keep someone from being shocked again. *The best hazard prevention method to avoid such an occurrence is to position the crane to keep a 10-foot clearance so the boom or hoist line cannot reach the power lines.*

Risks Presented by Power Line Contact

Power line contact is the greatest risk to be found in craning operations. A single contact can result in multiple deaths and/or crippling injuries. Each year approximately 150 to 160 people are killed by power line contact, and about three times that number are seriously injured. On an average, eight out of 10 of the victims were guiding the load at the time of contact.

Why Crane Power Line Contacts Occur

Power line contact usually occurs because no one considered the need for specific hazard prevention measures to avoid using cranes near power lines. All too often no prejob safety planning is done, so when the crane arrives at the worksite, the workers are placed in a hurried set of circumstances that burdens them with unreasonably dangerous tasks.

Preventive Measures

The key to avoiding power line contact is prejob safety planning. *Planning is one of the greatest accident deterrents available in the workplace.* Because of the large number of employers involved in controlling the workplace—landowner, construction management, prime contractor, subcontractors crane rental firms, electric utilities—planning is necessary to establish the person in charge.

A single individual should have overall supervision and coordination of the project and must initiate positive direction to ensure that prejob safety planning is done before any cranes arrive at the worksite.

Cranes and power lines should not occupy the same work area. In too many instances, work areas encompass existing power lines that have clearances acceptable for normal roadway traffic but not for cranes. The crane operator, those guiding the load and those closely involved in the particular craning operation need visual guidance from the ground so they are made aware of the danger zone and can conduct all of their work outside of this dangerous area. The area within a radius of

10 feet in any direction from power lines is an unsafe work area and must be clearly marked off on the ground by marker tape, fences, barriers, etc. That way, everyone at the worksite has the visual clues to ensure that the crane is positioned so that the boom and hoist line cannot intrude into the danger zone created by the power lines. Figure 10 shows how to map this danger zone surrounding power lines so it is impossible for the boom in any position or the hoist line to come closer than 10 feet and intrude into the danger zone. If the danger zone can be penetrated by a crane boom, the electric utility must be notified to deenergize, relocate, bury or insulate the lines while the crane is operating in that location.

Figure 10

Power Lines Properly Guarded to Prevent Contact With a Crane

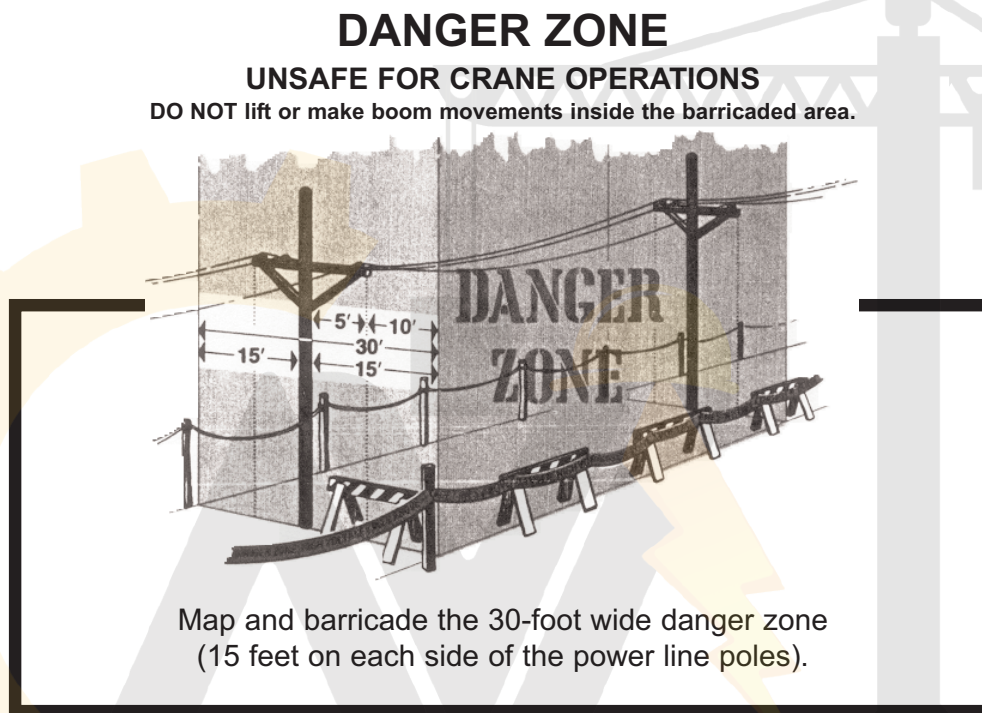

ALWAYS notify the power company before you begin crane operations near power lines.

It is extremely difficult for a crane operator to:

- Judge accurately clearances between a crane and power lines simply through the use of vision.
- See more than one visual target at a time.
- Overcome the camouflaging characteristics that trees, buildings and other objects have upon power lines.

Sometimes a crane operator cannot judge the clearance of the boom from the power line because the boom blocks the operator's view to the right. Sole reliance upon the performance of crane operators, riggers and signalers, without any planning to separate cranes from power lines, has resulted in many deaths.

Pick-and-carry operations with mobile cranes often result in power line contact, even though the same route had been taken previously. Cage-type boom guards, insulated links and proximity warning devices provide safety backups for operators, but such devices are not substitutes for maintaining the 10-foot clearance, which is most important. Use of these devices must be consistent with the product manufacturer's recommendations.

Truck-mounted trolleys or articulated crane booms that utilize an electrical remote control system to load or unload bricks, cement block, trusses and other building supplies have also caused many injuries and deaths. In the event the boom contacts a power line, the individual holding the control box at the end of the electrical control cable is usually electrocuted instantly. Such equipment should never be used near power lines. A safer purchase choice would be non-conductive, pneumatic-powered or remote radio control systems.

Controls for flatbed-mounted cranes that are located where they can be operated by an individual standing on the ground leaves the operator vulnerable to the initial fault current path in the event the boom strikes a power line.

Table 4 shows the safe working distance from power lines. Figure 11 illustrates the prohibited zone around a power line.

Table 4
Minimum Clearance Distances From Power Lines

A. While Operating	
Voltage (Nominal, kV, Alternating Current)	Minimum Clearance Distance (Feet)
Up to 50	10
Over 50 to 200	15
Over 200 to 350	20
Over 350 to 500	25
Over 500 to 750	35
Over 750 to 1,000	45
Over 1,000	(as established by the utility owner/ operator or registered professional engineer who is a qualified person with respect to electrical power transmission and distribution)
Note: The value that follows "to" is up to and includes the value. For example, over 50 to 200 means up to and including 200 kV.	
B. While Traveling With No Load and Boom/Mast Lowered	
Voltage (Nominal, kV, Alternating Current)	Minimum Clearance Distance (Feet)
Up to 0.75	4
Over .75 to 50	6
Over 50 to 345	10
Over 345 to 750	16
Over 750 to 1,000	20
Over 1,000	(as established by the utility owner/ operator or registered professional engineer who is a qualified person with respect to electrical power transmission and distribution)

Figure 11

Danger Zone for Cranes and Lifting Personnel Near Electrical Transmission Line

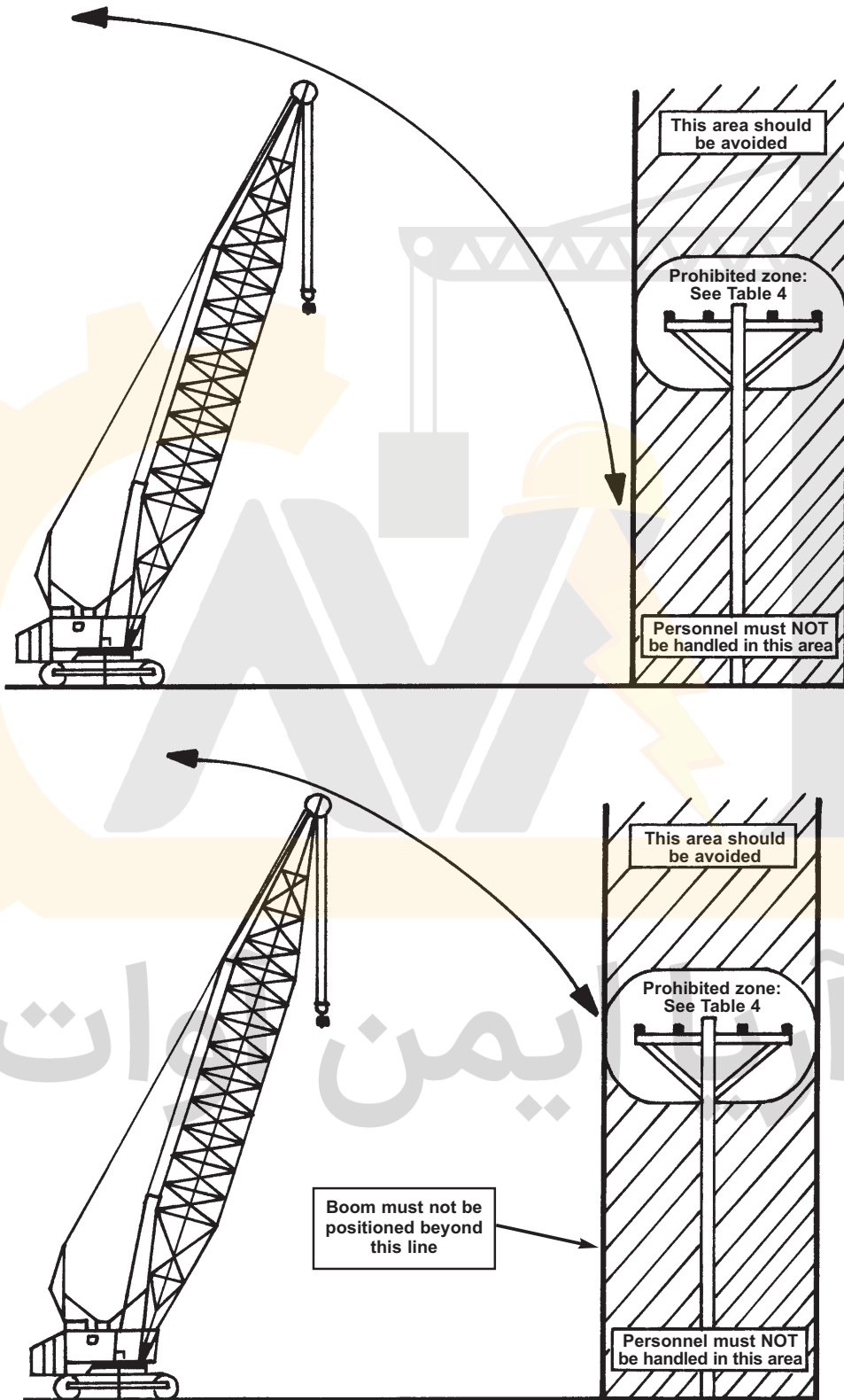

OSHA Requirements

- 29 CFR 1910.180(b)—Crawler locomotive and truck cranes—General requirements
- 29 CFR 1910.180(j)—Crawler locomotive and truck cranes—Operations near overhead lines
- 29 CFR 1910.333(c)(3)—Selection and use of work practices—Working on or near exposed energized parts—Overhead lines
- 29 CFR 1926.1407—1411—Cranes and derricks—Power line safety

Working Around Power Lines: Stay Away

Always Do	Never Do
<ul style="list-style-type: none"> • ALWAYS keep a safe distance of at least 10 feet between you and your equipment from the power lines. • ALWAYS survey the site for overhead power lines. LOOK UP! • ALWAYS, when using crane and/or equipment near energized power lines of 50,000 volts (50kV) or more, make sure the minimum distance between the lines and any part of the crane is 10 feet plus 4 inches for each 10kV over 50kV. • ALWAYS request an observer to assist you where it is difficult to maintain the desired clearance by visible means. • ALWAYS require that the only job of the observer is to help the operator maintain the safe clearance. • ALWAYS treat overhead power lines as if they were energized. • ALWAYS, when in doubt, call the electric company to find out what voltage is on the lines. • ALWAYS ask the electric company to either de-energize and ground the lines or install insulation while you are working near them. • ALWAYS make sure ladders and tools are non-conductive. 	<ul style="list-style-type: none"> • NEVER get closer than 10 feet to an overhead power line! • NEVER work at a site without checking for power lines. LOOK UP! • NEVER, when using cranes and/or equipment near energized power lines of 50,000 volts (50kV) or more, get closer than 10 feet plus 4 inches for each 10kV over 50kV. • NEVER use cranes and/or alone where it is difficult by visible means to maintain the desirable clearance. • NEVER forget that overhead power lines could be energized. • NEVER allow the observer to perform another job while helping the operator to maintain a safe clearance. • NEVER take a chance without consulting first with the electric company to find out what voltage the lines carry. • NEVER work near power lines until you are certain that they have been de-energized and grounded or insulated by the electric company. • NEVER work with ladders and tools if they have not been rated nonconductive.

Overloading

Definition

Overloading occurs when the rated capacity of a crane is exceeded while a load is being lifted and maneuvered, resulting in upset or structural failure.

Description

Cranes can easily upset from overloading. On some models the weight of a boom without a load can create an imbalance and cause some high-reach hydraulic cranes to upset when the boom is positioned at a low angle. This has occurred even with outriggers extended.

Today's crane operator is confronted with a number of variables that affect lifting capacity:

1. The ability to lower a boom increases the radius and reduces its capacity.
2. The ability to extend a hydraulic boom increases the radius and reduces lifting capacity.

3. The ability to lower a boom while extending a boom quickly reduces lifting capacity.
4. The crane's tipping capacity can vary when the boom is positioned at the various points of the compass or clock in relation to its particular carrier frame.
5. The operator may neglect to extend the outriggers and affect the crane's stability.
6. The operator may mistakenly rely upon perception, instinct or experience to determine whether the load is too heavy and may not respond fast enough when the crane begins to feel light. (Fundamental to a lift are prelift determinations of the weight of the load and the net capacity of the crane—29 CFR 1926.1417(o).)

All of these variables create conditions that lead to operators inadvertently exceeding the rated capacity, tipping the load and upsetting the crane. The variables may also lead to structural failure of the crane. That is, under certain loads and at particular configurations, the crane may break before it tips.

Risks Presented by Overloading

It is estimated that one crane upset occurs during every 10,000 hours of crane use. Approximately 3 percent of upsets result in death, 8 percent in lost time, and 20 percent in damage to property other than the crane. Nearly 80 percent of these upsets can be attributed to predictable human error when the operator inadvertently exceeds the crane's lifting capacity. This is why employers must ensure their operators' competence (see Table 5).

Table 5

Analysis of 1,000 Crane Upset Occurrences During a 20-Year Period

Approximately

15%	In travel mode
39%	Making swing with outriggers retracted
15%	Making a pick with outriggers retracted
14%	Making a pick or swing with outriggers extended
6%	Making a pick or swing; use of outriggers unknown
7%	Outrigger failure
4%	Other activity

Also reported:

3%	Deaths
8%	Lost-time injuries
20%	Significant property damage other than the crane

Why Overloading Occurs

Overloading occurs when poorly trained personnel are allowed to operate cranes. The operator must always know the weight of the load.

Preventive Measures

During the last 30 years much progress has been made in the availability of systems to prevent crane upset due to overloading. Crane operation is no longer a "seat-of-the-pants" skill but requires both planning and training in the use of the latest technologies such as load-measuring systems.

With the advent of solid-state micro-processing electronics, load-measuring systems evolved. Such systems can sense the actual load as related to boom angle and length, warn the operator as rated capacity is approached, and stop further movement. Load-measuring systems automatically prevent exceeding the rated capacity at any boom angle, length or radius. Today most U.S. crane manufacturers are promoting the sale of load-measuring systems as standard equipment on new cranes. There are after-market suppliers of these devices for older model cranes.

For years, the only control to avoid upset from overload has been reliance upon an operator's performance and the use of load charts. However, such charts are complex. Optimally, formal training should be provided for all crane operators, to ensure a working knowledge of crane load charts. However, on-the-job training can be adequate if the trainer is qualified.

OSHA Requirements

- 29 CFR 1910.179(b)(5)—Overhead and gantry cranes—Rated load marking
- 29 CFR 1910.180(c)—Crawler locomotive and truck cranes—Load ratings
- 29 CFR 1910.180(h)(3)—Crawler locomotive and truck cranes—Moving the load
- 29 CFR 1926.1417—Cranes and derricks—Operation
- 29 CFR 1926.1433—Cranes and derricks—Design, construction and testing

Failure to Use Outriggers; Soft Ground and Structural Failure

Definition

Crane upset can occur when an operator does not extend the outriggers or when a crane is positioned on soft ground.

Description

Many cranes upset because the use of outriggers is left to the discretion of the operator. For example, sometimes an operator cannot extend the outriggers because of insufficient space or a work circumstance that arises when planning is not done. Or outrigger pads may be too small to support the crane even on hard ground. However, the use of outriggers is not voluntary. Load capacity charts are based either on the use of fully extended outriggers or on “rubber,” for rubber-tired cranes. If circumstances are such that outriggers cannot be fully extended, then capacities in the on-rubber chart must be used.

Outriggers have collapsed because they were overloaded, defective or located on inadequate foundation. When outriggers are being used, carrier tires must not be supporting weight. They must be clear of the ground. Outrigger pads must be positively attached to the connecting cylinder.

Risks Presented by the Failure to Use Outriggers

An analysis of some 1,000 crane accidents (see Table 5) has shown that half of the incidents involving outriggers occurred when the crane operator was either swinging the cab or extending or lowering a boom without outriggers extended. These actions increase the lifting radius so upset occurs.

Why Outriggers Are Not Used

Supervisors and managers may unjustifiably rely upon their operators' knowledge of the need for outriggers. Management should assure itself that every crane operator is competent. Determining the load weight is generally viewed as the responsibility of the site supervisor, who must inform the operator before the lift is made. The operator must still be able to determine or estimate load weights, to evaluate and verify the weight provided. Based on the load weight, the operator knows if it is necessary to use outriggers. Management may also fail to insist that equipment brought onto the project be equipped with available safeguards, such as interlocks to restrict boom movement when outriggers are retracted.

Preventive Measures

Since such a high proportion of accidents occur when outriggers are not extended, design changes to overcome this hazard are needed. The surest way to avoid an accident is to make the machine inoperable until the operator activates necessary safeguards. Some aerial basket designs include limit switches to prevent boom movement until outriggers are extended and in place to avert upset. The newer aerial basket trucks have hydraulic systems with interlocks that preclude boom operation until outriggers are fully extended and fully supporting the crane, with wheels completely off the ground.

Soil failure occurs because the ground is too soft or the outrigger pads are not big enough. Soils range from wet sand that can only support 2,000 pounds per square foot to dry hard clay that can support 4,000 pounds per square foot to well-cemented hardpan that can support as much as 10,000 pounds per square foot. When poor soil is encountered, or the outriggers have inadequate floats or pads, well-designed blocking or cribbing is needed under the outriggers. On all types of cranes where floats are used OSHA requires that they be securely attached. It also requires that blocking used to support outriggers be strong enough to prevent crushing, be free of defects and be of sufficient width and length to prevent shifting or toppling under load.

OSHA Requirements

- 29 CFR 1910.180(h)(3)(ix)—Crawler locomotive and truck cranes—Handling the load
- 29 CFR 1926.1433—Cranes and derricks—Design, construction and testing

Two-Blocking

Definition

Two-blocking occurs when the hoist block or hook assembly comes into contact with the boom tip, causing the hoist line to break and the hook and load to fall, endangering workers below.

Description

Both latticework and hydraulic boom cranes are prone to two-blocking. When two-blocking occurs on latticework booms, the hoist line picks up the weight of the boom and lets the pendant guys go slack. Often a whip action is created when a crawler crane with a long boom without a load is “walking” and the headache ball and empty chokers can drift up to the boom tip. Ordinarily, while the operator is busy watching the pathway of travel to avoid any rough ground that can violently jerk the crane, he or she does not watch the boom tip. When a hoist line two-blocks, it assumes the weight of the boom and relieves the pin-up guys of the load. Then, if the crane crawler goes over a rock or bump, the flypole action of a long boom is sufficient to break the hoist line. The weight of the load plus the weight of the boom on a latticework boom (when combined with a little extra stress when lifting a load) can cause the hoist line to break if two-blocking occurs.

The power of the hydraulic rams that extend hydraulic booms is often sufficient to break the hoist line if two-blocking occurs. If operators fail to pay out the load line while extending the boom, the hoist line can be inadvertently broken. If the load line breaks while supporting a worker on a boatswain’s chair or several workers on a floating scaffold or a load above people, a catastrophe can result. When an operator must use two controls, one for the hoist and one for the hydraulic boom extension, the chance of error is increased.

In many circumstances, both latticework and hydraulic boom cranes will two-block when the hook is near the tip and the boom is lowered. Two-blocking incidents can also occur without resulting in actual failure, but causing damage that will result in failure at a later time.

Risks Presented by Two-Blocking

Hundreds of deaths and crippling injuries have resulted from two-blocking occurrences. Over the years, there have probably been thousands of two-blocking occurrences that have broken the hoist line. Most occurrences probably went unrecorded because no one was injured when the hoist line failed and dropped the hook and/or load.

Why Two-Blocking Occurs

Two-blocking occurs because the crane operator is often visually overtaxed. He or she is unable to watch the load and headache ball or hook simultaneously.

Preventive Measures

Anti-two-blocking devices have long been available, but industry acceptance of these devices as a preventive measure has lagged. OSHA requires an anti-two-blocking device or a two-block damage prevention feature where cranes are used to hoist personnel.

There are several ways to prevent two-blocking:

1. An anti-two-blocking device can be used. This device is a weighted ring around the hoist line that is suspended on a chain from a limit switch attached to the boom tip. When the hoist block or headache ball touches the suspended, weighted ring, the limit switch opens and an alarm warns the operator. It can also be wired to intercede and stop the hoisting. The circuitry is no more complex than an electric door bell.
2. On hydraulic cranes the hydraulic valving can be sequenced to pay out the hoist line when the boom is being extended, thus avoiding two-blocking.

3. Adequate boom length can be ensured to accommodate both the boom angle and sufficient space for rigging, such as slings, spreader bars and straps. To avoid bringing the hook and headache ball into contact with the boom tip, a boom length of 150 percent of the intended lift is required for a boom angle of 45 degrees or more.

OSHA Requirements

- 29 CFR 1910.179(g)(5)(iv)—Overhead and gantry cranes—Switches
- 29 CFR 1910.179(n)(4)(i)—Overhead and gantry cranes—Handling the load—Hoist limit switch
- 29 CFR 1926.1431—Cranes and derricks—Hoisting personnel

Pinchpoints

Definition

There are two types of crane pinchpoints:

1. Within the swinging radius of the rotating superstructure of a crane in areas in which people may be working, is a pinchpoint where people can be crushed or squeezed between the carrier frame and the crane cab, or the crane cab and an adjacent wall or other structure.
2. Many unguarded gears, belts, rotating shafts, etc., within the crane are pinchpoints to which employees may be exposed.

Description

A pinchpoint is created by the narrow clearance between the rotating superstructure (cab) of a crane and the stationary carrier frame. When a crane must be used in a confined space, another dangerous pinchpoint is the close clearance between the rotating cab/counterweight and a wall, post or other stationary object. This hazard is inherent in rough terrain cranes, truck-mounted cranes, crawler cranes and other mobile cranes. Many people, especially oilers, have been crushed by such pinchpoints.

Analysis of such occurrences shows that the victims usually entered the danger zone to access:

- the water jug
- the tool box
- the outrigger controls
- an area to perform maintenance
- an area for storage of rigging materials

In all of the known cases where someone entered the danger zone and was caught in a pinchpoint, the danger zone was outside the crane operator's vision. Survivors have stated that they believed the crane operator was not going to rotate or slew the boom at that particular moment.

Many unguarded moving parts are found in the machinery space, which serves as a shelter for the engine and hoist system.

Risks Presented by Pinchpoints

Many deaths or serious injuries have been recorded as a result of being crushed between the cab and carrier frame. Many amputations have been caused by unguarded moving parts within the crane.

Why Workers Are Crushed by the Rotating Cab

Workers have been crushed by the rotating cab because management failed to ensure that the crane was adequately barricaded and that all incentives to enter the swing zone were removed. Crane cabs are usually used for storage of lunch buckets, tools and supplies. The machinery that runs the crane requires oiling, adjustment and maintenance from time to time. Workers are, therefore, exposed to the hazard of the rotating cab and the hazard created by the many unguarded moving parts of the crane.

Preventive Measures

The swing area of the crane cab and counterweight must be barricaded against entry into the danger zone.

The removal of water jugs, tool boxes and rigging materials from crane cabs would reduce the incentive to enter the danger zone.

The installation of rear view mirrors for the crane operator provides an added safeguard so the operator can see into the turning area of the cab and counterweight.

OSHA Requirements

- 29 CFR 1926.1424—Cranes and derricks—Work area control
- 29 CFR 1910.180(i)(6)—Crawler locomotive and truck cranes—Swinging locomotive cranes
- Numerous OSHA standards address machine guarding and the guarding of moving parts

Obstruction of Vision

Definition

Safe use of a crane is compromised when the vision of an operator, rigger or signaler is blocked, and employees cannot see what the others are doing.

Description

There are two general categories for obstructions of operators' vision:

- obstruction by the crane's own bulk
- obstruction by the work environment

The crane size alone limits the operator's range of vision and creates many blind spots, preventing the rigger, signaler, oiler and others affected by the crane's movement from having direct eye contact with the crane operator. When a cab-controlled mobile crane is moved or travels back and forth, the operator must contend with many blind spots on the right side of the crane.

Many situations arise in craning activities that can almost instantaneously turn a simple lift into a life-taking catastrophe:

1. In many instances the work environment requires that loads be lifted to or from an area that is outside of the view of the operator. The crane boom may obstruct the operator's range of vision on the right side.
2. Often a load is lifted several stories high, and the crane operator must rely upon others to ensure safe movement of the load being handled.
3. Many people are affected by a crane's movement. Welders with their hoods on, carpenters, ironworkers or other workers may be working in the immediate vicinity of a crane, preoccupied with their tasks and unaware of the activity of the crane. They also may be out of the range of vision of the crane operator. Both the lack of awareness on the part of others and the obstructed vision of the crane operator contribute to craning accidents.

Risks Presented by Obstruction of Vision

When operators, riggers, signalers, oilers and others cannot see each other or the suspended load, the risk of accident becomes very high.

Why People Are Injured by Movement of the Load or the Crane

People are injured during craning when management fails to provide an effective communication system for the crane operator and signalers to ensure that all are aware of any changes in circumstances. Often signalers have not been adequately trained to perform their important task.

Preventive Measures

The key to a safe craning operation is the planning of all activities, starting with prejob conferences and continuing with daily planning to address any changes that need to be made.

To overcome the hazard of blind spots while loads are being lifted, the use of radios and telephones is much more effective than relying upon several signalers to relay messages by line of sight.

The use of automatic travel alarms is an effective way to warn those in the immediate vicinity of crane travel movement in pick-and-carry functions.

It should also be recognized that OSHA requires the windows of cranes to be made of safety glass or the equivalent, which does not introduce visible distortion that will interfere with the safe operation of the crane.

OSHA Requirements

- 29 CFR 1910.179(I)—Overhead and gantry cranes—Warning device
- 29 CFR 1926.16(a)—Rules of construction
- 29 CFR 1926.201(b)—Signaling—Crane and hoist signals
- 29 CFR 1926.1417—Cranes and derricks—Operation
- 29 CFR 1926.1419—Cranes and derricks—Signals—General requirements

Travel Upset in Mobile Hydraulic Cranes (Rough-Terrain and Wheel-Mounted Telescoping Boom)

Definition

Because of a high center of gravity, a mobile hydraulic crane can easily upset and crush the operator between the boom and the ground.

Description

This type of crane is easily overturned on road shoulders or other embankments during travel from one location to another.

Risks Presented by Travel Upsets

Numerous travel upsets have been recorded. When the mobile hydraulic crane upsets on the left side where the operator's cab is located, the lightweight sheet metal cab is easily crushed, usually trapping the operator before escape is possible. Crawler tractors can remain stable up to a 57 degree side slope. Mobile hydraulic cranes, however, are rarely stable on side slopes beyond 35 degrees. Because of their versatility with four-wheel drive and four-wheel steer, rough-terrain cranes do encounter slopes of over 35 degrees that could cause upset.

The lightweight sheet metal cab on almost all types of cranes is also vulnerable to crushing during upset from overloading as discussed in "Overloading," and the operator has no safe sanctuary in this type of cab to prevent serious injury.

Why Crane Operators Are Crushed When a Crane Upsets

Crush-resistant cabs are not routinely installed on cranes.

Preventive Measures

In the 1950s it was recognized that protective canopies that would resist the crushing effect of rollover could be designed and fabricated for heavy crawler-type bulldozers. Beginning in the late 1960s, rollover protection system (ROPS) standards were developed by the Society of Automotive Engineers (SAE) for tractors (both crawler and wheel), loaders, graders, compactors, scrapers, water wagons, rear dumps, bottom dumps, fifth wheel attachments, and various other pieces of equipment. Death and crippling injuries from rollover and falling objects have been substantially reduced because of ROPS. The same technology could be applied to mobile hydraulic cranes so operators would have the protection of a crush-resistant cab in the event of upset. The crane manufacturer or an after-market supplier should be contacted for installation of a crush-resistant cab and seatbelt.

Boom Disassembly on Latticework Boom Cranes

Definition

If a boom is not blocked, improper disassembly can cause it to collapse upon those who are removing pins under the boom while the boom is suspended.

Description

Latticework booms are disassembled for shortening, lengthening or transporting. Boom collapse occurs on truck- or crawler-mounted cranes when the boom is lowered to a horizontal position and suspended from the boom tip with pendant guys, but the boom is not blocked. If the lower pins connecting boom sections are knocked out by workers who are under the boom, the boom can collapse upon them, resulting in death or serious injuries.

Risks Presented by Boom Disassembly

There are at least three circumstances that lead to accidents when latticework boom sections are being dismantled:

1. Workers are unfamiliar with the equipment.
2. A poor location is chosen for dismantling.
3. Not enough time is allotted to meet the task deadline.

Why Workers Are Crushed by Latticework Booms During Disassembly

Workers are crushed during disassembly of latticework booms when there is a lack of supervision to ensure that the manufacturer's disassembly procedures are followed.

Preventive Measures

1. Plan boom disassembly location and procedures that are consistent with the manufacturer's instructions.
2. Use blocking or cribbing on each boom section. Figure 12 should be posted in the crane cab and Figure 13 should be attached to each boom section.
3. Use one of several types of pins that substantially reduce the risk of crushing, such as:
 - a. Double-ended pins that can be removed while one is standing beside the boom by driving the pin in from the outside. (See Dickie, D.E., *Crane Handbook*, Figure 3.41 at 78.)
 - b. Step pins that can only be inserted from inside facing out, and can only be removed by driving from the outside in. (See Dickie, D.E., *Crane Handbook*, Figure 3.39 at 78.)
 - c. Welded lugs that prevent pins from being entered the wrong way. This requires the pin to be inserted inside facing out and can only be removed by driving it from the outside in. (See Dickie, D.E., *Crane Handbook*, Figure 3.40 at 78).
 - d. Screw pins with threads that insert or retract the pin.
4. Post warnings at pin connections. Be sure that comprehensive text warning of this hazard and informing of ways to avoid it is contained in operators' manuals.

OSHA Requirements

- 29 CFR 1926.1417—Cranes and derricks—Operation

Figure 12

Unsafe (Upper) and Safe (Lower) Way to Block a Boom Section

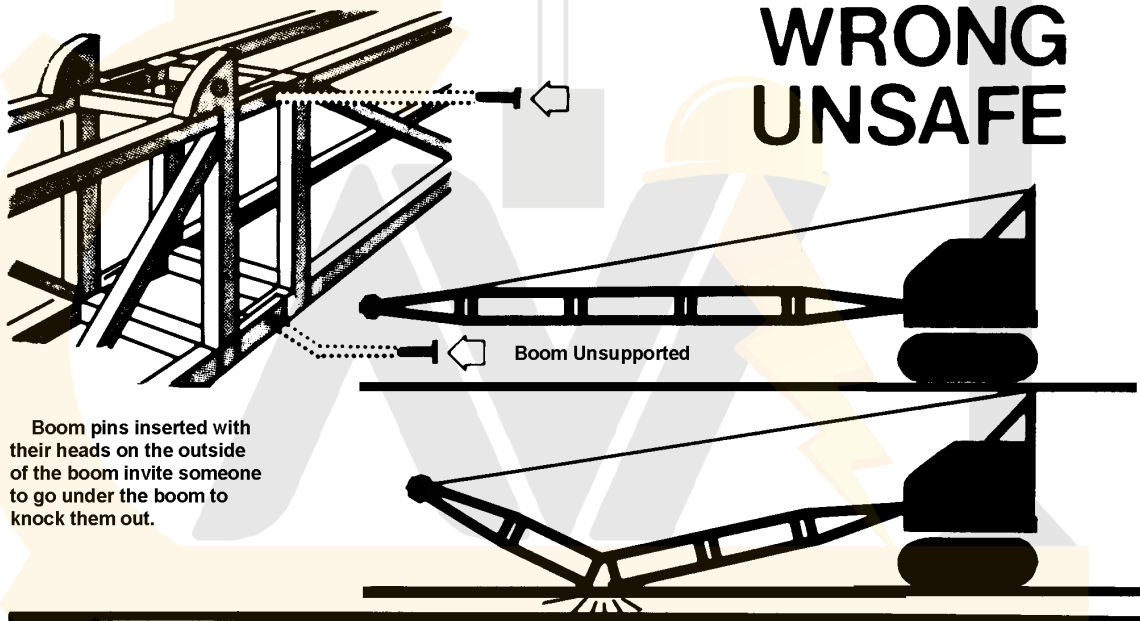

Boom pins inserted with their heads on the outside of the boom invite someone to go under the boom to knock them out.

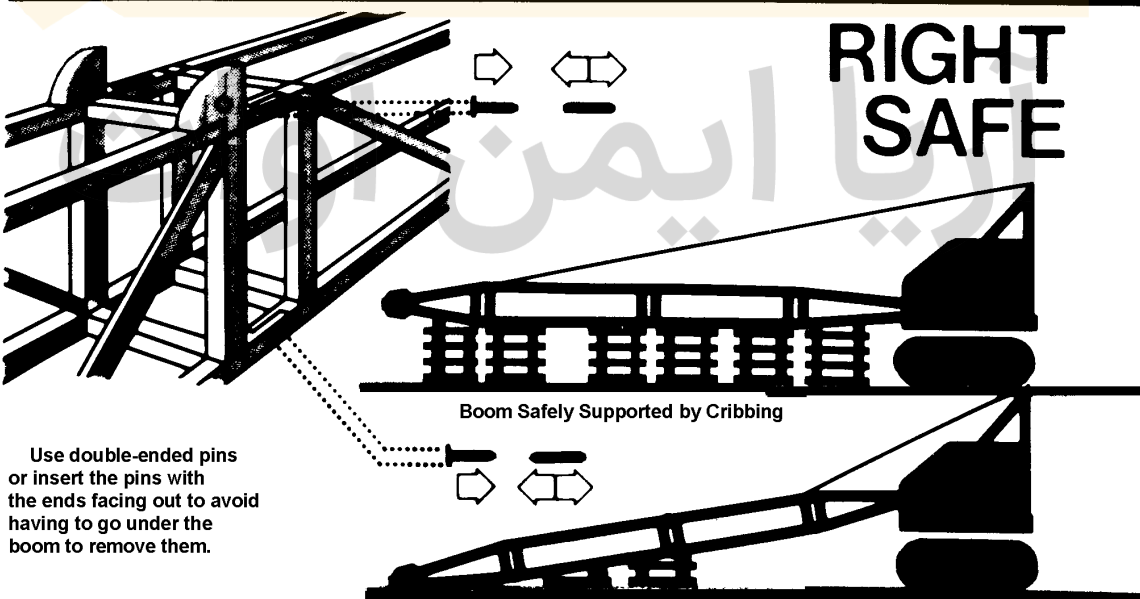

Use double-ended pins or insert the pins with the ends facing out to avoid having to go under the boom to remove them.

Figure 13

Sign to Be Attached on Each Boom Section



You will be Killed or Maimed when you disassemble an unsupported boom.

NEVER go under an unsupported boom to remove pins.

NEVER remove connecting pins from an unsupported boom.

SEE INSTRUCTIONS ON CRANE CAB

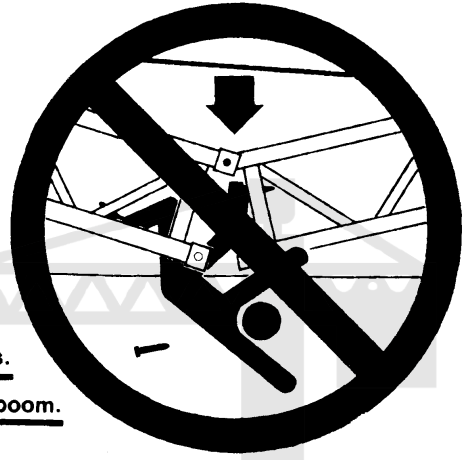

آریا ایمن آوات

Crane Safety Programs

North Carolina Cranes and Derricks Standards

Due to significant changes in construction consensus standards and requests from several industry stakeholders, federal OSHA has been working since 1998 on an update to 29 CFR Part 1926, Subpart N, designed to protect employees from the hazards associated with hoisting equipment when used to perform construction activities. These changes will affect establishments across a variety of different construction industries with work involving cranes and derricks.

In July 2002, OSHA announced its intent to use the negotiated rulemaking process to revise Subpart N and established the Cranes and Derricks Negotiated Rulemaking Advisory Committee (C-DAC), which comprised members from all sectors of the regulated community and from organized labor. The committee began meeting in August 2003 and completed its task in July 2004. As a result of these meetings, the committee submitted a proposed revision to Subpart N to OSHA on July 13, 2004. After years of review, OSHA published a notice of proposed rule in the Federal Register on Oct. 9, 2008.

While nationwide tower crane accidents have been in the news, most of the crane-related injuries and deaths in North Carolina involve mobile type cranes such as crawler cranes and truck cranes. Two recent tower crane accidents—one in New York and one in Florida—resulted in multiple fatalities. These events highlighted the inherently dangerous nature of work involving not only tower cranes but all types of cranes. Although each of these events occurred in states other than North Carolina, the national interest and concern warrant action.

After five high-profile crane accidents killed 15 people in 2008, Labor Commissioner Cherie Berry was approached by members of industry and asked to consider enacting updated occupational safety and health standards for those employees in North Carolina who operate and work around cranes. As a result, the commissioner decided to take the proactive approach and proposed adopting new rules for cranes and derricks that mirror the federal consensus document with some minor exceptions (e.g., organization and grouping to promote ease in reading and understanding by the regulated community in North Carolina). Federal OSHA has now issued a final rule to update the Cranes and Derricks in Construction standard. OSHA has revised the Cranes and Derricks Standard and related sections of the Construction Standards to update and specify industry work practices necessary to protect employees during the use of cranes and derricks in construction. In effort to remain as effective as U.S. Department of Labor, the N.C. Department of Labor repealed its state-specific standard and adopted the regulation promulgated by the U.S. Department of Labor that became effective Nov. 8, 2010.

Riggers, Signalers and Others

Riggers, signalers and others who work with cranes should have qualifications similar to those of the operator. Just as an unqualified operator can make a life-threatening error during lifting operations, the inappropriate actions of an inexperienced rigger, signaler or anyone else involved in lifting operations can cause an accident.

Hazard Prevention Requirements

Preconstruction Planning

Most crane accidents could have been easily prevented if basic considerations had been given to the safe use of cranes and had such considerations been incorporated at the preconstruction planning meeting. The planning stage meeting is the best time to address hazard avoidance. There, hazards inherent to power lines, blind lifts requiring communication, necessary lifting capacity, use of cranes and derricks on barges, and special circumstances requiring two or more cranes to lift a single load can be discussed and preventive measures can be taken. Planning before actual crane operations begin can eliminate major craning hazards from the jobsite and make operations more efficient.

Job Hazard Analysis

Before actual craning operations are begun at the jobsite, a specific job hazard analysis should be conducted to ensure that preconstruction planning is adequate. When prejob planning has been neglected, this on-site job hazard analysis is necessary to ensure that craning operations can be done safely.

Hand Signals

Before any lifts are commenced, all parties, including the crane operator, signalers, riggers and others involved, must refamiliarize themselves with appropriate hand signals. Often signals vary from job to job and region to region. It is best to ensure that everyone is familiar with the hand signals outlined in ANSI/ASME B30.5, Mobile and Locomotive Cranes (see Figure 16). The standard states that “When using hand signals, the Standard Method must be used.” (29 CFR 1926.1419(c)(1)) The standard references ASME B30.3-2004 and ASME B30.5-2004. (29 CFR 1926.1401)

Signaling Devices

On lifts where the signalers are outside the direct view of the operator due to elevation or in blind areas, either a telephone or radio is necessary. Modes of communication must be agreed upon in preconstruction planning and in the job hazard analysis.

Lifting Capabilities

During preconstruction planning, lifting requirements should be analyzed by an engineer competent to establish whether the crane to be used has adequate lifting capability. The job hazard analysis should also verify that the crane to be used has sufficient boom length for the lift.

Rigging Practices

The requirements for slings to support loads are well defined in OSHA standards 29 CFR 1910.184, and the requirements for rigging equipment are defined in 29 CFR 1926.251 and 29 CFR 1926.1431(g)(3).

Controlling the Load

The use of tag lines to control movement of the load is very important. Normally, when a load is being hoisted, the lay or twist in wire rope causes rotation when the load becomes suspended. OSHA standard 29 CFR 1910.180(h)(3)(xvi) states: “... A tag or restraint line shall be used when rotation of the load is hazardous.”

Wire Rope Requirements

It is very important to comply with the crane manufacturer’s recommendations for the type of wire rope to be used for various hoist lines or pendants.

Annual Inspections

A number of business firms are certified to perform annual crane inspections. A notice of the current inspection should be posted in the crane. Cranes that cannot be certified must be removed from service until all necessary repairs are made and the equipment is reinspected. Annual crane inspections are required by 29 CFR 1910.179(j), 29 CFR 1910.180(d), 29 CFR 1910.181(d) and 29 CFR 1926.1412.

Preventive Maintenance

Cranes require ongoing service and preventive maintenance. Preventive maintenance programs should be documented according to the crane manufacturer’s recommendations.

Figure 14
Dynamics of Setting Up a Crane

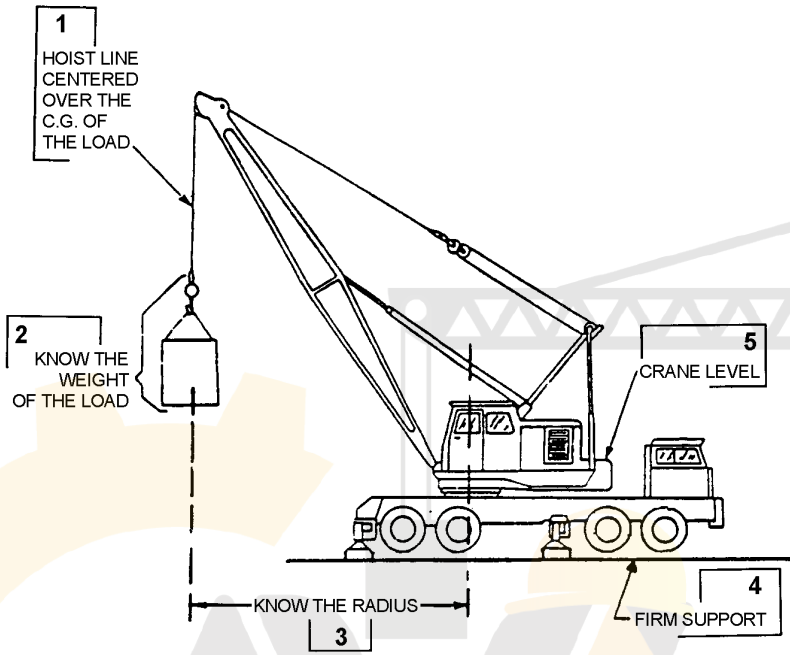

Figure 15
Crane nomenclature

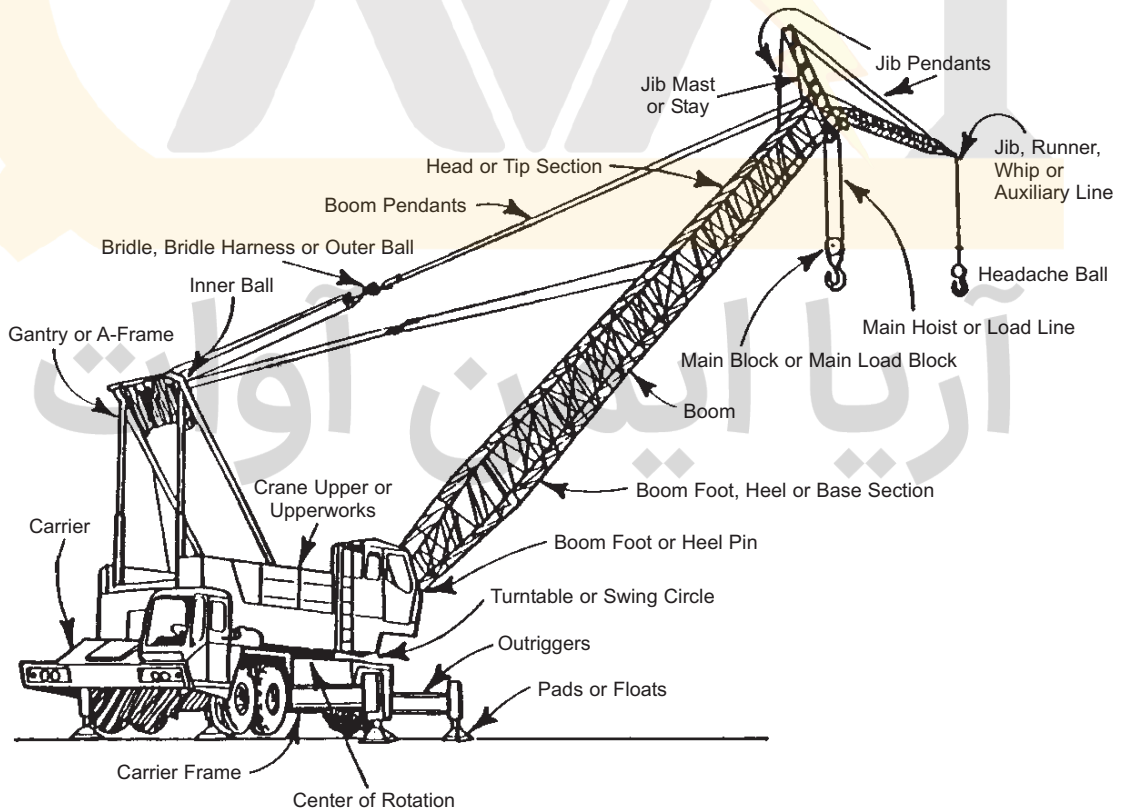
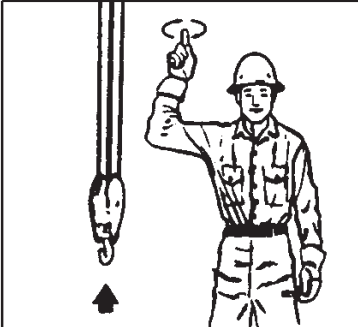
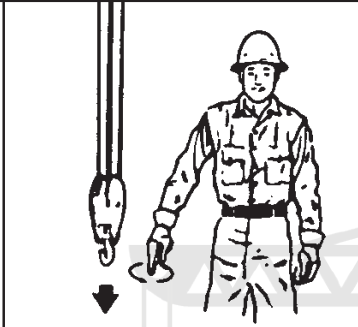
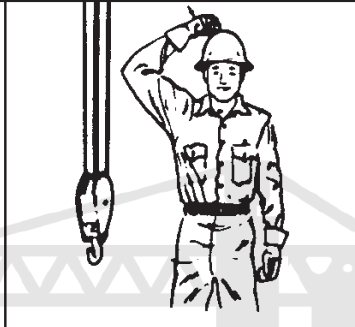
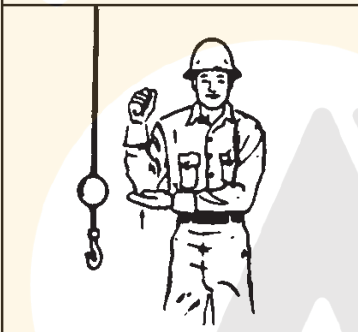
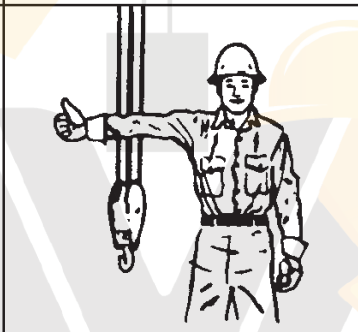
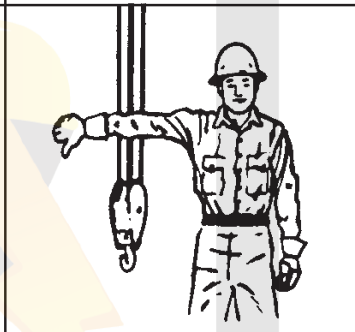
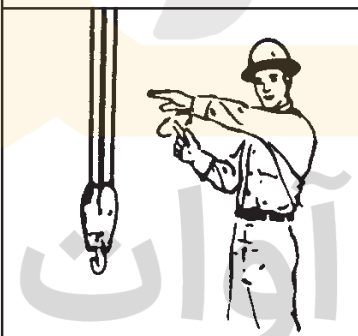
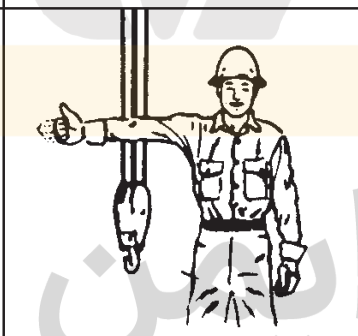
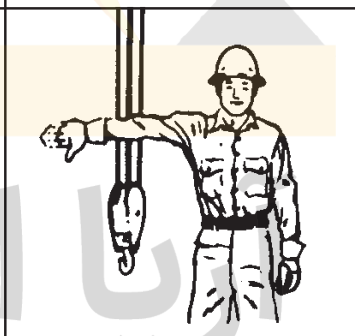
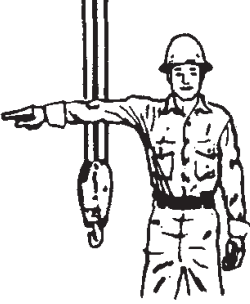
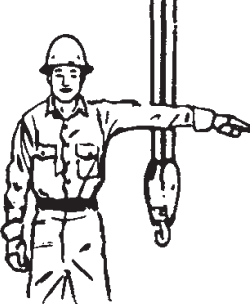
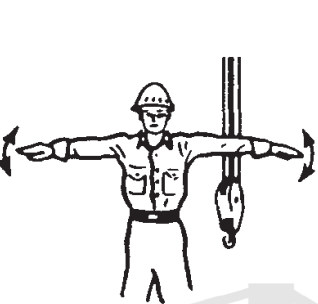
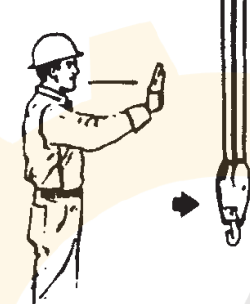

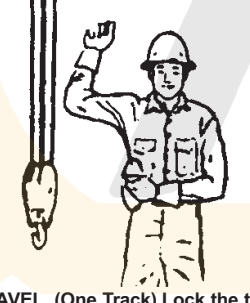





Figure 16

Standard Hand Signals for Controlling Crane Operations

 <p>HOIST. With forearm vertical, forefinger pointing up, move hand in small horizontal circle.</p>	 <p>LOWER. With arm extended downward, forefinger pointing down, move hand in small horizontal circle.</p>	 <p>USE MAIN HOIST. Tap fist on head; then use regular signals.</p>
 <p>USE WHIPLINE. (Auxiliary Hoist). Tap elbow with one hand; then use regular signals.</p>	 <p>RAISE BOOM. Arm extended, fingers closed, thumb pointing upward.</p>	 <p>LOWER BOOM. Arm extended, fingers closed, thumb pointing downward.</p>
 <p>MOVE SLOWLY. Use one hand to give any motion signal and place other hand motionless in front of hand giving the motion signal. (Hoist slowly shown as example.)</p>	 <p>RAISE THE BOOM AND LOWER THE LOAD. With arm extended, thumb pointing up, flex fingers in and out as long as load movement is desired.</p>	 <p>LOWER THE BOOM AND RAISE THE LOAD. With arm extended, thumb pointing down, flex fingers in and out as long as load movement is desired.</p>

 <p>SWING. Arm extended, point with finger in direction of swing of boom.</p>	 <p>STOP. Arm extended, palm down, move arm back and forth horizontally.</p>	 <p>EMERGENCY STOP. Both arms extended, palms down, move arms back and forth horizontally.</p>
 <p>TRAVEL. Arm extended forward, hand open and slightly raised, make pushing motion in direction of travel.</p>	 <p>DOG EVERYTHING. Clasp hands in front of body.</p>	 <p>TRAVEL. (Both Tracks). Use both fists in front of body, making a circular motion about each other, indicating direction of travel, forward or backward. (For land cranes only.)</p>
 <p>TRAVEL. (One Track) Lock the track on side indicated by raised fist. Travel opposite track in direction indicated by circular motion of other fist, rotated vertically in front of body. (For land cranes only.)</p>	 <p>EXTEND BOOM (Telescoping Booms). Both fists in front of body with thumbs pointing outward.</p>	 <p>RETRACT BOOM (Telescoping Booms). Both fists in front of body with thumbs pointing toward each other.</p>
 <p>EXTEND BOOM (Telescoping Boom). One Hand Signal. One fist in front of chest with thumb tapping chest.</p>		 <p>RETRACT BOOM (Telescoping Boom). One Hand Signal. One fist in front of chest, thumb pointing outward and heel of fist tapping chest.</p>

References

OSHA Requirements

Crane or Derrick Suspended Personnel Platforms, OSHA 3100 (Revised 2002), USDOL/OSHA
29 CFR 1926 Subpart CC—Cranes and Derricks in Construction, 29 CFR 1926.1400–1442
North Carolina Occupational Safety and Health Standards for General Industry (29 CFR 1910)
North Carolina Occupational Safety and Health Standards for the Construction Industry (29 CFR 1926)
U.S. Department of Energy (DOE), DOE Standard Hoisting and Rigging (Formerly Hoisting and Rigging Manual), DOE-STD-1090-2001, April 2001
Pocket Reference Guide for Power Line Clearance, Construction Safety Council, Hillside, Ill., 800-552-7744
Wire Rope Slings pocket reference guide, Institute of the Ironworking Industry, 202-783-3998

ANSI Standards

ANSI B15.1—Safety Standards for Mechanical Power Transmission Apparatus
ANSI C2—National Electrical Safety Code
ANSI/IEEE C2 National Electrical Safety Code Interpretations, 1961–1977 Inclusive
ANSI/IEEE C2 National Electrical Safety Code Interpretations, 1978–1980 Inclusive, and Interpretations Prior to the 6th Edition
ANSI Z35.1—Specifications for Accident Prevention Signs

Recommended Guidance (Society of Automotive Engineers, *SAE Handbook*, v.4)

SAE J115—Safety Signs
SAE J159—Crane Load Moment System
SAE J185—Access Systems for Off-Road Machines
SAE J220—Crane Boomstop
SAE J375—Radius-of-Load and Boom Angle Measuring System
SAE J376—Load Indicating Devices in Lifting Crane Service
SAE J765—Crane Load Stability Test Code
SAE J820—Crane Hoist Line Speed and Power Test Code
SAE J881—Lifting Crane Sheave and Drum Sizes

SAE J959—Lifting Crane, Wire-Rope Strength Factors
SAE J983—Crane and Cable Excavator Basic Operating Control Arrangements
SAE J987—Crane Structures Method of Test
SAE J999—Crane Boom Hoist Disengaging Device
SAE J1028—Mobile Crane Working Area Definitions
SAE J1040c—Performance Criteria for Rollover Protective Structures (ROPS) for Construction, Earthmoving, Forestry, and Mining Machines
SAE J1063—Cantilevered Boom Crane Structures Method of Test
SAE J1180—Telescoping Boom Length Indicating System
SAE J1238—Rating Lift Cranes on Fixed Platforms Operating
SAE J1257—Rating Chart for Cantilevered Boom Cranes
SAE J1289—Mobile Crane Stability Ratings
SAE J1332—Rope Drum Rotation Indicating Device

Bureau of the Construction Manufacturer’s Association. Power Crane and Shovel Association. *Cable Controlled Power Cranes, Draglines, Hoes, Shovels, and Clamshells*.
Bureau of the Construction Manufacturer’s Association. Power Crane and Shovel Association. *Hydraulic Excavators and Telescoping Boom Cranes*.
Bureau of the Construction Manufacturer’s Association. Power Crane and Shovel Association. *Mobile Hydraulic Crane Standards*. PSCA Standard No. 2.

Bureau of the Construction Manufacturer's Association. Power Crane and Shovel Association. *Mobile Power Crane and Excavator Standards*. PSCA Standard No. 1.
 Dickie, D.E. 1975. *Crane Handbook*. Construction Safety Association of Ontario.
 National Fire Protection Association. Cranes and Hoists. *National Electrical Code*. Chapter 6, Article 610.
 U.S. Army Corps of Engineers. Department of the Army. *Safety and Health Requirements Manual*. EM 385-1-1.

ASME B30 SERIES

TYPE CRANE/EQUIPMENT

ASME B30.1	Jacks
ASME B30.2	Overhead and Gantry Cranes (Top Running Bridge, Multiple Girder; Top Running Trolley Hoist)
ASME B30.3	Construction Tower Cranes
ASME B30.4	Portal, Tower, and Pedestal Cranes
ASME B30.5	Crawler, Locomotive, and Truck Cranes
ASME B30.6	Derricks
ASME B30.7	Base Mounted Drum Hoists
ASME B30.8	Floating Cranes and Floating Derricks
ASME B30.9	Slings
ASME B30.10	Hooks
ASME B30.11	Monorails and Underhung Cranes
ASME B30.12	Handling Loads Suspended From Rotorcraft
ASME B30.13	Storage/Retrieval (S/R) Machines and Associated Equipment
ASME B30.14	Side Boom Tractors
ASME B30.15	Mobile Hydraulic Cranes (Note: B30.15-1973 has been withdrawn. The revision of B30.15 is included in the latest edition of B30.5)
ASME B30.16	Overhead Hoists (Underhung)
ASME B30.17	Overhead and Gantry Cranes (Top Running Bridge, Single Girder, Underhung Hoist)
ASME B30.18	Stacker Cranes (Top or Under Running Bridge, Multiple Girder With Top or Under Running Trolley Hoist)
ASME B30.19	Cableways
ASME B30.20	Below-the-Hook Lifting Devices
ASME B30.21	Manually Lever Operated Hoist
ASME B30.22	Articulating Boom Cranes
ASME B30.23	Personnel Lifting Systems
ASME B30.24	Container Cranes
ASME B30.25	Scrap and Material Handlers
ASME B30.26	Rigging Hardware
ASME B30.27	Material Placement Systems
ASME B30.28	Balance Lifting Units ¹

ASME B56.1 Low Lift and High Lift Trucks
 ASME B56.6 Rough Terrain Forklift Trucks
 ASME PALD Portable Automotive Lifting Devices
 ASME MH11.4 Forks and Fork Carriers for Powered Industrial Fork Lift Trucks

Construction Safety Association (CSA) of Ontario
 "The Rigging Handbook"

Society of Automotive Engineers, Inc. (SAE)
 SAE J1028, "Mobile Crane Working Area Definitions"

1. B30.28 is in the development stage

Table of Contents

29 CFR 1926 Subpart CC—Cranes and Derricks in Construction

29 CFR 1926.1400	Scope.
29 CFR 1926.1401	Definitions.
29 CFR 1926.1402	Ground conditions.
29 CFR 1926.1403	Assembly/Disassembly—selection of manufacturer or employer procedures.
29 CFR 1926.1404	Assembly/Disassembly—general requirements (applies to all assembly and disassembly operations).
29 CFR 1926.1405	Disassembly—additional requirements for dismantling of booms and jibs (applies to both the use of manufacturer procedures and employer procedures).
29 CFR 1926.1406	Assembly/Disassembly—employer procedures—general requirements.
29 CFR 1926.1407	Power line safety (up to 350 kV)—assembly and disassembly.
29 CFR 1926.1408	Power line safety (up to 350 kV)—equipment operations.
29 CFR 1926.1409	Power line safety (over 350 kV).
29 CFR 1926.1410	Power line safety (all voltages)—equipment operations closer than the Table A zone.
29 CFR 1926.1411	Power line safety—while traveling.
29 CFR 1926.1412	Inspections.
29 CFR 1926.1413	Wire rope—inspection.
29 CFR 1926.1414	Wire rope—selection and installation criteria.
29 CFR 1926.1415	Safety devices.
29 CFR 1926.1416	Operational aids.
29 CFR 1926.1417	Operation.
29 CFR 1926.1418	Authority to stop operation.
29 CFR 1926.1419	Signals—general requirements.
29 CFR 1926.1420	Signals—radio, telephone or other electronic transmission of signals.
29 CFR 1926.1421	Signals—voice signals—additional requirements.
29 CFR 1926.1422	Signals—hand signal chart.
29 CFR 1926.1423	Fall protection.
29 CFR 1926.1424	Work area control.
29 CFR 1926.1425	Keeping clear of the load.
29 CFR 1926.1426	Free fall and controlled load lowering.
29 CFR 1926.1427	Operator qualification and certification.
29 CFR 1926.1428	Signal person qualifications.
29 CFR 1926.1429	Qualifications of maintenance & repair employees.
29 CFR 1926.1430	Training.
29 CFR 1926.1431	Hoisting personnel.
29 CFR 1926.1432	Multiple-crane/derrick lifts—supplemental requirements.
29 CFR 1926.1433	Design, construction and testing.
29 CFR 1926.1434	Equipment modifications.
29 CFR 1926.1435	Tower cranes.
29 CFR 1926.1436	Derricks.
29 CFR 1926.1437	Floating cranes/derricks and land cranes/derricks on barges.
29 CFR 1926.1438	Overhead & gantry cranes.
29 CFR 1926.1439	Dedicated pile drivers.
29 CFR 1926.1440	Sideboom cranes.
29 CFR 1926.1441	Equipment with a rated hoisting/lifting capacity of 2,000 pounds or less.
29 CFR 1926.1442	Severability.
Appendix A to Subpart CC of Part 1926—Standard Hand Signals	
Appendix B to Subpart CC of Part 1926—Assembly/Disassembly—Sample Procedures for Minimizing the Risk of Unintended Dangerous Boom Movement	
Appendix C to Subpart CC of Part 1926—Operator Certification—Written Examination—Technical Knowledge Criteria	
See complete information and listing of standards at following website: http://www.osha.gov/cranes-derricks/index.html	

Glossary

Most of these definitions are in the 1926.1401 standard. A few other key terms have been added to this list to assist with clarification.

1. A/D director (Assembly/Disassembly director) means an individual who meets this subpart's requirements for an A/D director, irrespective of the person's formal job title or whether the person is non-management or management personnel.
2. Assembly/Disassembly means the assembly and/or disassembly of equipment covered under this standard. With regard to tower cranes, "erecting and climbing" replaces the term "assembly," and "dismantling" replaces the term "disassembly." Regardless of whether the crane is initially erected to its full height or is climbed in stages, the process of increasing the height of the crane is an erection process.
3. Assembly/Disassembly: The assembly and disassembly of equipment covered under this Section. With regard to tower cranes, "erecting and climbing" replaces the term "assembly," and "dismantling" replaces the term "disassembly."
4. Assembly/Disassembly Supervisor ("A/D Supervisor"): An individual who meets this Section's requirements for an A/D supervisor, irrespective of the person's formal job title or whether the person is non-management or management personnel.
5. Attachments means any device that expands the range of tasks that can be done by the equipment. Examples include, but are not limited to: An auger, drill, magnet, pile-driver, and boom-attached personnel platform.
6. Attachment: Any device that expands the range or tasks that can be done by the equipment. Examples include an auger, drill, magnet, pile-driver, and boom-attached personnel platform.
7. Audible signal means a signal made by a distinct sound or series of sounds. Examples include, but are not limited to, sounds made by a bell, horn, or whistle.
8. Audible Signal: A signal made by a distinct sound or series of sounds. Examples include sounds made by a bell, horn, or whistle.
9. Bird Caging means the twisting of fiber or wire rope in an isolated area in the opposite direction of the rope lay, thereby causing it to take on the appearance of a bird cage.
10. Blocking (also referred to as "cribbing") is wood or other material used to support equipment or a component and distribute loads to the ground. It is typically used to support lattice boom sections during assembly/disassembly and under outrigger and stabilizer floats.
11. Blocking (also referred to as "cribbing"): Wood or other material used to support equipment or a component and distribute loads to the ground. Blocking is typically used to support latticed boom sections during assembly/disassembly and under outrigger floats.
12. Boatswain's Chair: A single-point adjustable suspension scaffold consisting of a seat or sling (which may be incorporated into a full body harness) designed to support one employee in a sitting position.
13. Bogie means "travel bogie," which is defined below.
14. Boom (equipment other than tower crane) means an inclined spar, strut, or other long structural member which supports the upper hoisting tackle on a crane or derrick. Typically, the length and vertical angle of the boom can be varied to achieve increased height or height and reach when lifting loads. Booms can usually be grouped into general categories of hydraulically extendible, cantilevered type, latticed section, cable supported type or articulating type.
15. Boom (equipment other than tower crane): An inclined spar, strut, or other structural member which supports the upper hoisting tackle on a crane or derrick. Typically, the length and vertical angle of the boom can be varied to achieve increased height or height and reach when lifting loads. Booms can usually be grouped into general categories of hydraulically extendible, cantilevered type, latticed section, cable supported type or articulating type.
16. Boom: if the "boom" (i.e., principle horizontal structure) is fixed, it is referred to as a jib; if it is moveable up and down, it is referred to as a boom.

17. Boom Angle Indicator: A device which measures the angle of the boom relative to horizontal.
18. Boom Hoist Limiting Device: A device that disengages boom hoist power when the boom reaches a predetermined operating angle. It also sets brakes or closes valves to prevent the boom from lowering after power is disengaged. This includes a boom hoist disengaging device, boom hoist shut-off, boom hoist disconnect, boom hoist hydraulic relief, boom hoist kick-outs, automatic boom stop device, or derricking limiter.
19. Boom Length Indicator: The length of the permanent part of the boom (such as ruled markings on the boom) or, as in some computerized systems, the length of the boom with extensions/attachments.
20. Boom Stop: A device that restricts the boom from moving a certain maximum angle and toppling over backward. This includes boom stops, belly straps with struts/standoff, telescoping boom stops, attachment boom stops, and backstops.
21. Boom Suspension Systems: A system of pendants, running ropes, sheaves, and other hardware which supports the boom tip and controls the boom angle.
22. Builder means the builder/constructor of equipment.
23. Center of Gravity: The point in an object around which its weight is evenly distributed, such that if a support is placed under that point, the object could balance on the support.
24. Certified welder means a welder who meets nationally recognized certification requirements applicable to the task being performed.
25. Certified Welder: A welder who meets certification requirements applicable to the task being performed, in accordance with the American Welding Society or the American Society of Mechanical Engineers.
26. Climbing: The process in which a tower crane is raised to a new working height, either by adding additional tower sections to the top of the crane (top climbing), or by a system in which the entire crane is raised inside the structure (inside climbing).
27. Come-A-Long: A mechanical device typically consisting of a chain or cable attached at each end that is used to facilitate movement of materials through leverage.
28. Competent Person: A person who is capable of identifying existing and predictable hazards in the surroundings or working conditions which are unsanitary, hazardous, or dangerous to employees, and who has authorization from his employer to take prompt corrective measures to eliminate them.
29. Controlled Load Lowering: Lowering a load by means of a mechanical hoist drum device that allows a hoisted load to be lowered with maximum control using the gear train or hydraulic components of the hoist mechanism. Controlled load lowering requires the use of the hoist drive motor, rather than the load hoist brake, to lower the load.
30. Controlling Entity: A prime contractor, general contractor, construction manager or any other legal entity which has the overall responsibility for the construction of the projects, including its planning, quality and completion.
31. Counterweight: A weight used to supplement the weight of equipment in providing stability for lifting loads by counterbalancing those loads.
32. Crane/derrick includes all equipment covered by this subpart.
33. Crane Level Indicator: A device for determining true horizontal.
34. Crane, Articulating: A crane whose boom consists of a series of folding, pin-connected structural members, typically manipulated to extend or retract by power from hydraulic cylinders.
35. Crane, Assist: A crane used to assist in assembling or disassembling a crane.
36. Crane, Crawler: Equipment that has a type of base mounting which incorporates a continuous belt of sprocket driven track.
37. Crane, Floating (or Floating Derrick): Equipment designed by the manufacturer (or employer) for marine use by permanent attachment to a barge, pontoons, vessel or other means of flotation.

38. Crane, Land (or Land Derrick): Equipment not originally designed by the manufacturer for marine use by permanent attachment to barges, pontoons, vessels, or other means of flotation.
39. Crane, Locomotive: A crane mounted on a base or car equipped for travel on a railroad track.
40. Crane, Mobile: A lifting device incorporating a cable suspended latticed boom or hydraulic telescopic boom designed to be moved between operating locations by transport over the road. These are referred to in Europe as a crane mounted on a truck carrier.
41. Crane, Overhead and Gantry includes overhead/bridge cranes, semigantry, cantilever gantry, wall cranes, storage bridge cranes, launching gantry cranes, and similar equipment, irrespective of whether it travels on tracks, wheels, or other means.
42. Crane, Portal: A type of crane consisting of a rotating upperstructure, hoist machinery, and boom mounted on top of a structural gantry which may be fixed in one location or have travel capability. The gantry legs or columns usually have portal openings in between to allow passage of traffic beneath the gantry.
43. Crane, Side-Boom: A track-type or wheel-type tractor having a boom mounted on the side of the tractor, used for lifting, lowering, or transporting a load suspended on the load hook. The boom or hook can be lifted or lowered in a vertical direction only.
44. Crane, Tower: A type of lifting structure which utilizes a vertical mast or tower to support a working boom (jib) suspended from the working boom. While the working boom may be fixed horizontally or have luffing capability, it can always rotate about the tower center to swing loads. The tower base may be fixed in one location or ballasted and moveable between locations.
45. Critical lift: A crane lifting operation involving an exceptional level of risk due to factors such as load weight, lifting height, procedural complications, or proximity to situational hazards. Critical lifts are often identified by conditions exceeding a specified percentage of the crane's rated capacity (75%), however, any more complex issues may be involved.
46. Crossover Points: The locations on a wire rope which is spooled on a drum where one layer of rope climbs up on and crosses over the previous layer. This takes place at each flange of the drum as the rope is spooled on the drum, reaches the flange, and begins to wrap back in the opposite direction.
47. Dedicated Channel: A line of communication assigned by the employer who controls the communication system to only one signal person and crane/derrick or to a coordinated group of cranes/derricks/signal person(s).
48. Dedicated Pile-Driver: A machine that is designed to function exclusively as a pile-driver. These machines typically have the ability to both hoist the material that will be pile-driven and to pile-drive that material.
49. Dedicated Spotter (power lines): A person who meets the requirements of 13 NCAC 07F .0905 (signal person qualifications) and whose sole responsibility is to watch the separation between the power line and the equipment, the load line and the load (including rigging and lifting accessories), and ensure through communication with the operator that the applicable minimum approach distance is not breached.
50. Directly Under the Load: A part or all of an employee is directly beneath the load.
51. Dismantling includes partial dismantling (such as dismantling to shorten a boom or substitute a different component).
52. Drum Rotation Indicator: A device on a crane or hoist which indicates in which direction and at what relative speed a particular hoist drum is turning.
53. Electrical Contact: When a person, object, or equipment makes contact or comes in close proximity with an energized conductor or equipment that allows the passage of current.
54. Employer-Made Equipment: Equipment designed and built by an employer for its own use.
55. Encroachment: When any part of the crane, load line or load (including rigging and lifting accessories) breaches a minimum clearance distance that this Section requires to be maintained from a power line.
56. Equipment means equipment covered by this subpart.
57. Equipment Criteria: Instructions, recommendations, limitations and specifications.

58. Fall Protection Equipment: Guardrail systems, safety net systems, personal fall arrest systems, positioning device systems or fall restraint systems.
59. Fall Restraint System: A fall protection system that prevents the user from falling any distance. The system is comprised of either a body belt or body harness, along with an anchorage, connectors and other necessary equipment. The other components typically include a lanyard, and may also include a lifeline and other devices.
60. Fall zone means the area (including but not limited to the area directly beneath the load) in which it is reasonably foreseeable that partially or completely suspended materials could fall in the event of an accident.
61. Fall Zone: The area (including the area directly beneath the load) in which it is reasonably foreseeable that partially or completely suspended materials could fall in the event of an accident.
62. Flange Points: A point of contact between rope and drum flange where the rope changes layers.
63. Free Fall (of the load line): When only the brake is used to regulate the descent of the load line (the drive mechanism is not used to drive the load down faster or retard its lowering).
64. Free Surface Effect: Uncontrolled transverse movement of liquids in compartments which reduce a vessel's transverse stability.
65. Functional testing: The testing of a crane, typically done with a light load or no load, to verify the proper operation of a crane's primary function, i.e. hoisting, braking, booming, swinging, etc. A functional test is contrasted to testing the crane's structural integrity with heavy loads.
66. Hoist: A mechanical device for lifting and lowering loads by winding rope onto or off of a drum.
67. Hoisting: The act of raising, lowering or otherwise moving a load in the air with equipment covered by this Section. As used in this Section, "hoisting" can be done by means other than wire rope/hoist drum equipment.
68. Include/including means "including, but not limited to."
69. Insulating Link/Device: An insulating device approved by a Nationally Recognized Testing Laboratory, as that term is defined in 29 CFR 1910.7(b).
70. Jib Stop (a.k.a. Jib Backstop): Is similar to a boom stop but is for a fixed or luffing jib.
71. List: The angle of inclination about the longitudinal axis of a barge, pontoons, vessel or other means of flotation.
72. Load: The weight of the object being lifted or lowered, including the weight of the load-attaching equipment such as the load block, ropes, slings, shackles, and any other ancillary attachment.
73. Load Moment Indicator (also referred to as Rated Capacity Indicator): A system which aids the equipment operator by sensing the overturning moment on the equipment, i.e. load X radius. It compares this lifting condition to the equipment's rated capacity, and indicates to the operator the percentage of capacity at which the equipment is working. Lights, bells, or buzzers may be incorporated as a warning of an approaching overload condition.
74. Load Moment Limiter (also referred to as Rated Capacity Limiter): A system which aids the equipment operator by sensing the overturning moment on the equipment, i.e. load X radius. It compares this lifting condition to the equipment's rated capacity, and when the rated capacity is reached, it shuts off power to those equipment functions which can increase the severity of loading on the equipment, e.g., hoisting, telescoping out, or luffing out. Typically, those functions which decrease the severity of loading on the equipment remain operational, e.g., lowering, telescoping in, or luffing in.
75. Luffing Jib Limiting Device: Is similar to a boom hoist limiting device, except that it limits the movement of the luffing jib.
76. Marine Hoisted Personnel Transfer Device: A device, such as a "transfer net," that is designed to protect the employees being hoisted during a marine transfer and to facilitate rapid entry into and exit from the device. Such devices do not include boatswain's chairs when hoisted by equipment covered by this Section.
77. Marine Worksite: A construction worksite located in, on or above the water.
78. Moving Point-To-Point: The times during which an employee is in the process of going to or from a work station.

79. **Multi-Purpose Machine:** A machine that is designed to be configured in various ways, at least one of which allows it to hoist (by means of a winch or hook) and horizontally move a suspended load. For example, a machine that can rotate and can be configured with removable tongs (for use as a forklift) or with a winch pack, a jib with a hook at the end, or a jib used in conjunction with a winch. When configured with the tongs, it is not covered by this Section. When configured with a winch pack, a jib with a hook at the end, or a jib used in conjunction with a winch, it is covered by this Section.
80. **Nationally recognized accrediting agency** is an organization that, due to its independence and expertise, is widely recognized as competent to accredit testing organizations. Examples of such accrediting agencies include, but are not limited to, the National Commission for Certifying Agencies and the American National Standards Institute.
81. **Nationally Recognized Accrediting Agency:** An organization that is accredited by the National Commission for Certifying Agencies (NCCA) or the American National Standards Institute (ANSI) to establish standards for and assess the formal activities of testing organizations applying for or continuing their accreditation.
82. **Nonconductive:** That, because of the nature and condition of the materials, used, and the conditions of use (including environmental conditions and condition of the material), the object in question has the property of not becoming energized (that is, it has high dielectric properties offering a high resistance to the passage of current under the conditions of use).
83. **Operational aids** are devices that assist the operator in the safe operation of the crane by providing information or automatically taking control of a crane function. These include, but are not limited to, the devices listed in § 1926.1416 (“listed operational aids”).
84. **Operational Aids:** Devices that assist the operator in the safe operation of the crane by providing information or automatically taking control of a crane function. These include the devices listed in 13 NCAC 07F .0917 (“listed operational aids”).
85. **Operational Controls:** Levers, switches, pedals and other devices for controlling equipment operation.
86. **Operator** means a person who is operating the equipment.
87. **Paragraph** refers to a paragraph in the same section of this subpart that the word “paragraph” is used, unless otherwise specified.
88. **Pendants:** Includes both wire and bar types. Wire type pendants mean a fixed length of wire rope with mechanical fittings at both ends for pinning segments of wire rope together. Bar type pendants mean that instead of wire rope, a bar is used. Pendants are typically used in a latticed boom crane system to easily change the length of the boom suspension system without completely changing the rope on the drum when the boom length is increased or decreased.
89. **Personal Fall Arrest System:** A system used to arrest an employee in a fall from a working level. It consists of an anchorage, connectors, and a body harness and may include a lanyard, deceleration device, lifeline, or a combination of these.
90. **Power Lines:** Electrical distribution and electrical transmission lines.
91. **Procedures** include, but are not limited to: Instructions, diagrams, recommendations, warnings, specifications, protocols and limitations.
92. **Procedures:** Include instructions, diagrams, recommendations, warnings, specifications, protocols, and limitations.
93. **Proximity Alarm:** A device that provides a warning of proximity to a power line that has been approved by a Nationally Recognized Testing Laboratory, as that term is defined in 29 CFR 1910.7(b).
94. **Qualified Engineer:** An engineer that is licensed as a professional engineer with the North Carolina Board of Examiners for Engineers and Surveyors.
95. **Qualified Evaluator (not a third party):** A person employed by the signal person's employer who has demonstrated to his employer that he/she is competent in accurately assessing whether individuals meet the Qualification Requirements in this Section for a signal person.
96. **Qualified Evaluator (third party):** An independent entity that has demonstrated to the employer its competence to accurately assess whether individuals meet the Qualification Requirements in this Section for a signal person.

97. Qualified Person: A person who, by possession of a degree, certificate, or professional standing, or who by knowledge, training and experience, successfully demonstrated to his employer an ability to solve/resolve problems relating to the subject matter, the work, or the project.
98. Qualified Rigger: A rigger who meets the criteria for a qualified person.
99. Range control limit device is a device that can be set by an equipment operator to warn that the boom or jib tip is at a plane or multiple planes.
100. Range Control Warning Device: A device that can be set by an equipment operator to warn that the boom or jib tip is at a plane or multiple planes.
101. Rated Capacity: The maximum working load permitted by the manufacturer under specified working conditions. Such working conditions typically include a specific combination of factors such as equipment configuration, radii, boom length, and other parameters of use.
102. Repetitive Pickup Points: When an operation involves the rope being used on a single layer and being spooled repetitively over a portion of the drum.
103. Rotation Resistant Rope: A type of wire rope construction which reduces the tendency of a rope to rotate about its axis under load. Usually, this consists of an inner system of core strands laid in one direction covered by an outer system of strands laid in the opposite direction.
104. Running Wire Rope: A wire rope that moves over sheaves or drums.
105. Runway: A firm, level surface designed, prepared and designated as a path of travel for the weight and configuration of the crane being used to lift and travel with the crane suspended platform. An existing surface may be used as long as it meets these criteria.
106. Section means a section of this subpart, unless otherwise specified.
107. Special Hazard Warnings: Warnings of site-specific hazards (for example, proximity of power lines).
108. Stability (flotation device): The tendency of a barge, pontoons, vessel or other means of flotation to return to an upright position after having been inclined by an external force.
109. Standard Method: The hand signals established in ASME B30.3-2004 and ASME B30.5-2004.
110. Standing Wire Rope: A supporting wire rope which maintains a constant distance between the points of attachment to the two components connected by the wire rope.
111. Such as means “such as, but not limited to.”
112. Tagline: A rope (usually fiber) attached to a lifted load for purposes of controlling load spinning and pendular motions or used to stabilize a bucket or magnet during material handling operations.
113. Tender: An individual responsible for monitoring and communicating with a diver.
114. Tilt Up or Tilt Down Operation: Raising or lowering a load from the horizontal to vertical or vertical to horizontal.
115. Travel Bogie (also referred to as Bogie): An assembly of two or more axles arranged to permit vertical wheel displacement and equalize the loading on the wheels.
116. Trim: The angle of inclination about the transverse axis of a barge, pontoons, vessel or other means of flotation.
117. Two Blocking: A condition in which a component that is uppermost on the hoist line such as the load block, hook block, overhaul ball, or similar component, comes in contact with the boom tip, fixed upper block or similar component. This binds the system and continued application of power can cause failure of the hoist rope or other component.
118. Unavailable Procedures: Procedures that are no longer available from the manufacturer, or have never been available from the manufacturer.
119. Upperworks (also referred to as Superstructure or Upperstructure): The revolving frame of equipment on which the engine and operating machinery are mounted along with the operator's cab. The counterweight is typically supported on the rear of the upperstructure and the boom or other front end attachment is mounted on the front.

120. Up to means “up to and including.”

121. Wire rope means a flexible rope constructed by laying steel wires into various patterns of multi-wired strands around a core system to produce a helically wound rope.

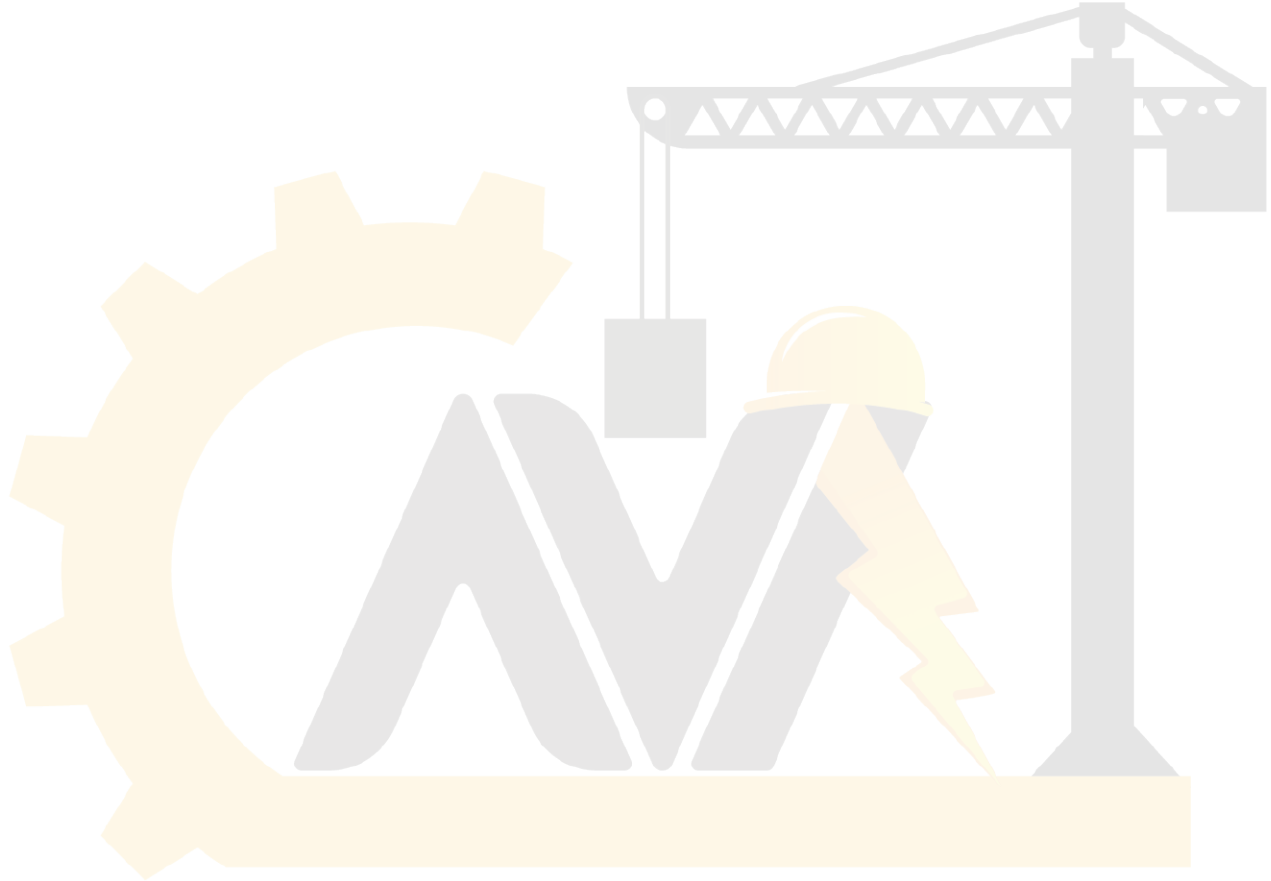

آریا ایمن آوات

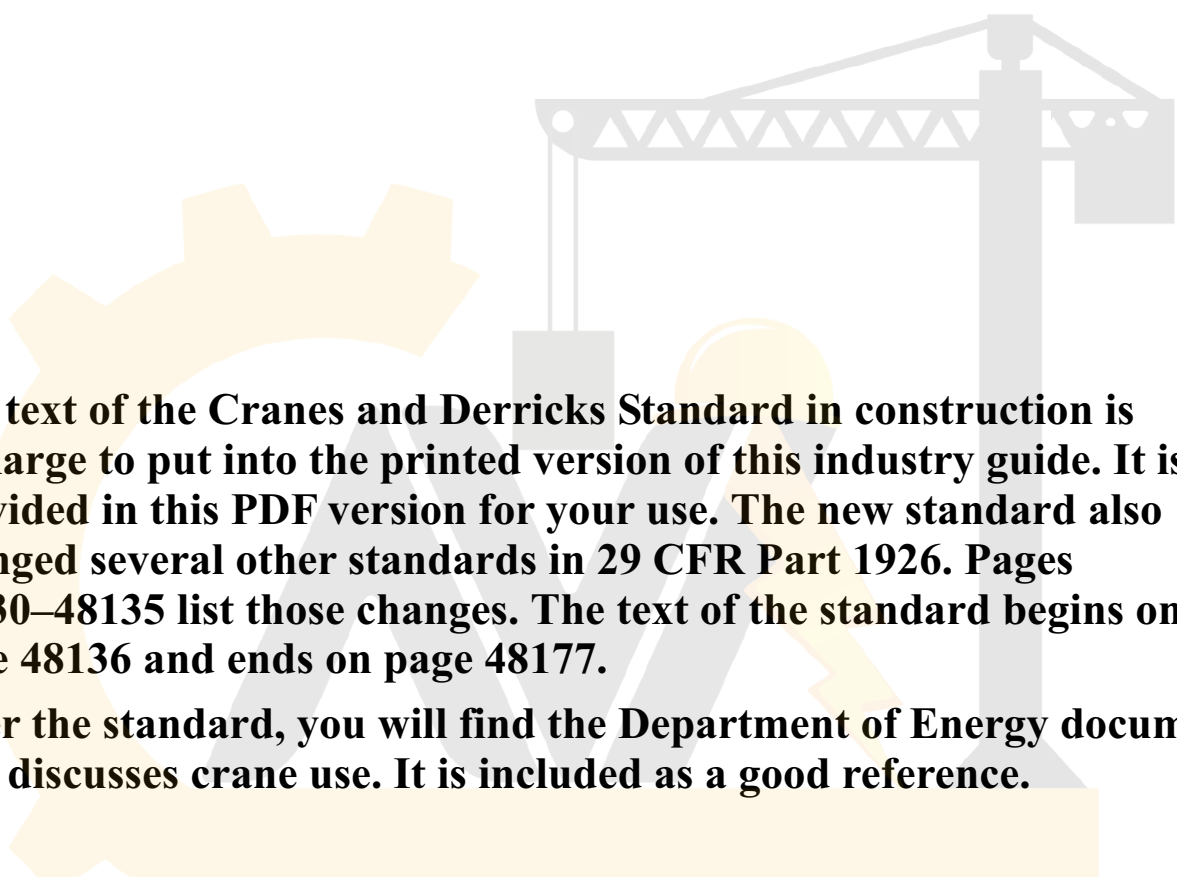

The text of the Cranes and Derricks Standard in construction is too large to put into the printed version of this industry guide. It is provided in this PDF version for your use. The new standard also changed several other standards in 29 CFR Part 1926. Pages 48130–48135 list those changes. The text of the standard begins on page 48136 and ends on page 48177.

After the standard, you will find the Department of Energy document that discusses crane use. It is included as a good reference.

آریا ایمن آوات

Virginia, Washington, and Wyoming; Connecticut, Illinois, New Jersey, New York, and the Virgin Islands have OSHA-approved State Plans that apply to State and local government employees only.

This final rule results in more stringent requirements for the work it covers. Therefore, States and Territories with approved State Plans must adopt comparable amendments to their standards within six months of the promulgation date of this rule unless they demonstrate that such amendments are not necessary because their existing standards are at least as effective in protecting workers as this final rule.

F. Unfunded Mandates Reform Act

OSHA reviewed this final rule according to the Unfunded Mandates Reform Act of 1995 ("UMRA"; 2 U.S.C. 1501 *et seq.*) and Executive Order 12875 (58 FR 58093, Oct. 28, 1993). As discussed above in section V.B of this preamble ("Summary of the Final Economic Analysis, and Regulatory Flexibility Analysis"), the Agency estimates that compliance with this rule will require private-sector employers to expend about \$154.1 million each year. However, while this rule establishes a Federal mandate in the private sector, the Agency's standards do not apply to State, local, or Tribal governments except in States that have elected voluntarily to adopt a State Plan approved by the Agency. Consequently, this final rule does not meet the definition of a "Federal intergovernmental mandate" (*see sec. 421(5) of the UMRA (2 U.S.C. 658(5))*). However, the rule imposes costs of over \$100 million per year on the private sector, and is thus subject to the requirement under UMRA for review of private sector costs. That requirement is met in section V.B. of the preamble.

G. Applicability of Existing Consensus Standards

Some of the types of equipment subject to this final standard are addressed by current national consensus standards in the ASME B30 series, including: ASME B30.5–2004, "Mobile and Locomotive Cranes"; ASME B30.6–2003, "Derricks"; ASME B30.8–2004, "Floating Cranes and Floating Derricks"; ASME B30.3–2004, "Construction Tower Cranes"; ASME B30.14–2004, "Side Boom Tractors"; and ASME B30.2–2001, "Overhead and Gantry Cranes." In addition, ASME B30.7–2005, "Base-Mounted Drum Hoists," addresses a type of equipment that is often a component of derricks, and ASME B30.23–2005, "Personnel Lifting Systems," addresses issues that are

covered by § 1926.1431, *Hoisting personnel*.

The Committee consulted these ASME standards (or the most current versions available at the time) and other resources in developing its proposal. In most instances, the ASME standards that the Committee consulted were entered into the docket, including: ASME B30.5–2000 (OSHA–S030–2006–0663–0334); ASME B30.5a–2002 Addenda (OSHA–S030–2006–0663–0335); ASME B30.6–2003 (OSHA–S030–2006–0663–0337); ASME B30.17–2003 (OSHA–S030–2006–0663–0338); ASME B30.3–1996 (OSHA–S030–2006–0663–0353); and ASME B30.23–1998 (OSHA–S030–2006–0663–0354). When newer versions of the ASME standards were issued after the Committee finished its work, OSHA examined the updated standards to determine if the provisions of the updated standards deviated in a significant way from provisions on which the Committee relied. OSHA entered the updated standards into the record of this rulemaking. For the most part, OSHA did not find significant deviations between the updated versions and the versions reviewed by the Committee. In the few instances in which deviations occurred, OSHA identified those deviations and asked for public comment on any issues raised.

As discussed in detail in the Summary and Explanation of the standard, a number of provisions in this final rule contain concepts that are similar to the concepts underlying the various ASME standards. However, the Committee determined that, in most instances, the wording of the provisions in these ASME standards needed revision to improve the enforceability, clarity, and ease of use.

For some issues, the ASME standards do not address issues covered by this final rule, or the Committee determined that a different approach was necessary. For example, in the provisions on inspections (§§ 1926.1412 and 1926.1413), the Committee concluded that shift, monthly, and annual inspection intervals are most appropriate, in contrast to the ASME approach, which uses "frequent" and "periodic" intervals. In the provisions addressing assembly/disassembly (§§ 1926.1403 through 1926.1406) and the encroachment-prevention provisions for power lines (§§ 1926.1407 through 1926.1411), the Committee adopted approaches with no comparable counterparts in the ASME standards.

In some instances, the Committee determined that it was appropriate to incorporate ASME standards by reference, in whole or in part. For

example, in § 1926.1433 (*Design, construction and testing*), the rule incorporates by reference ANSI B30.5–1968, safety code for "Crawler, Locomotive, and Truck Cranes," PCSA Std. No. 2 (1968), for crawler, truck and locomotive cranes manufactured prior to the effective date of this final rule, and incorporates portions of ASME B30.5a–2004, "Mobile and Locomotive Cranes," for mobile cranes (including crawler and truck cranes) and locomotive cranes manufactured on or after the effective date of this final rule.

List of Subjects in 29 CFR Part 1926

Construction industry, Incorporation by reference, Occupational safety and health, Safety.

VI. Authority and Signature

David Michaels, PhD, MPH, Assistant Secretary of Labor for Occupational Safety and Health, U.S. Department of Labor, 200 Constitution Ave., NW., Washington, DC 20210, directed the preparation of this notice. The Agency is issuing this final rule under the following authorities: Sections 4, 6(b), 8(c), and 8(g) of the Occupational Safety and Health Act of 1970 (29 U.S.C. 653, 655, 657); Section 3704 of the Contract Work Hours and Safety Standards Act (40 U.S.C. 3701 *et seq.*); Section 4 of the Administrative Procedure Act (5 U.S.C. 553); Secretary of Labor's Order No. 5–2007 (72 FR 31159, Jun. 5, 2007); and 29 CFR part 1911.

Signed at Washington, DC, on July 16, 2010.

David Michaels,

Assistant Secretary of Labor for Occupational Safety and Health.

VII. Amendments to Standards

■ For the reasons stated in the preamble of this final rule, the Agency is amending 29 CFR part 1926 to read as follows:

PART 1926—[AMENDED]

Subpart A—General

■ 1. The authority citation for subpart A of 29 CFR part 1926 is retained as follows:

Authority: Sec. 3704, Contract Work Hours and Safety Standards Act (40 U.S.C. 333); secs. 4, 6, and 8, Occupational Safety and Health Act of 1970 (29 U.S.C. 653, 655, 657); Secretary of Labor's Order No. 12–71 (36 FR 8754), 8–76 (41 FR 25059), 9–83 (48 FR 35736), 6–96 (62 FR 111), or 5–2007 (72 FR 31160) as applicable; and 29 CFR part 1911.

■ 2. Section 1926.6 is added to read as follows:

§ 1926.6 Incorporation by reference.

(a) The standards of agencies of the U.S. Government, and organizations which are not agencies of the U.S. Government which are incorporated by reference in this part, have the same force and effect as other standards in this part. Only the mandatory provisions (*i.e.*, provisions containing the word "shall" or other mandatory language) of standards incorporated by reference are adopted as standards under the Occupational Safety and Health Act. The locations where these standards may be examined are as follows:

(1) Offices of the Occupational Safety and Health Administration, U.S. Department of Labor, Frances Perkins Building, Washington, DC 20210.

(2) The Regional and Field Offices of the Occupational Safety and Health Administration, which are listed in the U.S. Government Manual.

(b) The materials listed in paragraphs (g) through (ff) of this section are incorporated by reference in the corresponding sections noted as they exist on the date of the approval, and a notice of any change in these materials will be published in the **Federal Register**. These incorporations by reference were approved by the Director of the Federal Register in accordance with 5 U.S.C. 552(a) and 1 CFR part 51.

(c) Copies of standards listed in this section and issued by private standards organizations are available for purchase from the issuing organizations at the addresses or through the other contact information listed below for these private standards organizations. In addition, these standards are available for inspection at the National Archives and Records Administration (NARA). For information on the availability of these standards at NARA, telephone: 202-741-6030, or go to http://www.archives.gov/federal_register/code_of_federal_regulations/ibr_locations.html. Also, the standards are available for inspection at any Regional Office of the Occupational Safety and Health Administration (OSHA), or at the OSHA Docket Office, U.S. Department of Labor, 200 Constitution Avenue, NW., Room N-2625, Washington, DC 20210; telephone: 202-693-2350 (TTY number: 877-889-5627).

(d) [Reserved.]

(e) [Reserved.]

(f) [Reserved.]

(g) The following material is available for purchase from the American Conference of Governmental Industrial Hygienists (ACGIH), 1330 Kemper Meadow Drive, Cincinnati, OH 45240; telephone: 513-742-6163; fax: 513-

742-3355; e-mail: mail@acgih.org; Web site: <http://www.acgih.org>:

(1) Threshold Limit Values of Airborne Contaminants for 1970, 1970, IBR approved for § 1926.55(a) and Appendix A of § 1926.55.

(h) The following material is available for purchase from the American National Standards Institute (ANSI), 25 West 43rd Street, Fourth Floor, New York, NY 10036; telephone: 212-642-4900; fax: 212-302-1286; e-mail: info@ansi.org; Web site: <http://www.ansi.org/>.

(1) ANSI A10.3-1970, Safety Requirements for Explosive-Actuated Fastening Tools, IBR approved for § 1926.302(e).

(2) ANSI A10.4-1963, Safety Requirements for Workmen's Hoists, IBR approved for § 1926.552(c).

(3) ANSI A10.5-1969, Safety Requirements for Material Hoists, IBR approved for § 1926.552(b).

(4) ANSI A11.1-1965 (R1970), Practice for Industrial Lighting, IBR approved for § 1926.56(b).

(5) ANSI A17.1-1965, Elevators, Dumbwaiters, Escalators, and Moving Walks, IBR approved for § 1926.552(d).

(6) ANSI A17.1a-1967, Elevators, Dumbwaiters, Escalators, and Moving Walks Supplement, IBR approved for § 1926.552(d).

(7) ANSI A17.1b-1968, Elevators, Dumbwaiters, Escalators, and Moving Walks Supplement, IBR approved for § 1926.552(d).

(8) ANSI A17.1c-1969, Elevators, Dumbwaiters, Escalators, and Moving Walks Supplement, IBR approved for § 1926.552(d).

(9) ANSI A17.1d-1970, Elevators, Dumbwaiters, Escalators, and Moving Walks Supplement, IBR approved for § 1926.552(d).

(10) ANSI A17.2-1960, Practice for the Inspection of Elevators (Inspector's Manual), IBR approved for § 1926.552(d).

(11) ANSI A17.2a-1965, Practice for the Inspection of Elevators (Inspector's Manual) Supplement, IBR approved for § 1926.552(d).

(12) ANSI A17.2b-1967, Practice for the Inspection of Elevators (Inspector's Manual) Supplement, IBR approved for § 1926.552(d).

(13) ANSI A92.2-1969, Vehicle Mounted Elevating and Rotating Work Platforms, IBR approved for §§ 1926.453(a) and 1926.453(b).

(14) ANSI B7.1-1970, Safety Code for the Use, Care, and Protection of Abrasive Wheels, IBR approved for §§ 1926.57(g), 1926.303(b), 1926.303(c), and 1926.303(d).

(15) ANSI B20.1-1957, Safety Code for Conveyors, Cableways, and Related

Equipment, IBR approved for § 1926.555(a).

(16) ANSI B56.1-1969, Safety Standards for Powered Industrial Trucks, IBR approved for § 1926.602(c).

(17) ANSI J6.1-1950 (R1971), Rubber Insulating Line Hose, IBR approved for § 1926.951(a).

(18) ANSI J6.2-1950 (R1971), Rubber Insulating Hoods, IBR approved for § 1926.951(a).

(19) ANSI J6.4-1971, Rubber Insulating Blankets, IBR approved for § 1926.951(a).

(20) ANSI J6.5-1971, Rubber Insulating Sleeves, IBR approved for § 1926.951(a).

(21) ANSI J6.6-1971, Rubber Insulating Gloves, IBR approved for § 1926.951(a).

(22) ANSI J6.7-1935 (R1971), Rubber Matting for Use Around Electric Apparatus, IBR approved for § 1926.951(a).

(23) ANSI O1.1-1961, Safety Code for Woodworking Machinery, IBR approved for § 1926.304(f).

(24) ANSI Z35.1-1968, Specifications for Accident Prevention Signs, IBR approved for § 1926.200(i).

(25) ANSI Z35.2-1968, Specifications for Accident Prevention Tags, IBR approved for § 1926.200(i).

(26) ANSI Z49.1-1967, Safety in Welding and Cutting, IBR approved for § 1926.350(j).

(27) ANSI Z87.1-1968, Practice for Occupational and Educational Eye and Face Protection, IBR approved for § 1926.102(a).

(28) ANSI Z89.1-1969, Safety Requirements for Industrial Head Protection, IBR approved for § 1926.100(b).

(29) ANSI Z89.2-1971, Industrial Protective Helmets for Electrical Workers, Class B, IBR approved for §§ 1926.100(c) and 1926.951(a).

(i) [Reserved.]

(j) The following material is available for purchase from the American Society for Testing and Materials (ASTM), ASTM International, 100 Barr Harbor Drive, PO Box C700, West Conshohocken, PA, 19428-2959; telephone: 610-832-9585; fax: 610-832-9555; e-mail: service@astm.org; Web site: <http://www.astm.org/>:

(1) ASTM A370-1968, Methods and Definitions for Mechanical Testing and Steel Products, IBR approved for § 1926.1001(f).

(2) ASTM B117-1964, 50 Hour Test, IBR approved for § 1926.959(a).

(3) ASTM D56-1969, Standard Method of Test for Flash Point by the Tag Closed Tester, IBR approved for § 1926.155(i).

(4) ASTM D93-1969, Standard Method of Test for Flash Point by the

Pensky Martens Closed Tester, IBR approved for § 1926.155(i).

(5) ASTM D323–1958 (R1968), Standard Method of Test for Vapor Pressure of Petroleum Products (Reid Method), IBR approved for § 1926.155(m).

(k) The following material is available for purchase from the American Society of Agricultural and Biological Engineers (ASABE), 2950 Niles Road, St. Joseph, MI 49085; telephone: 269–429–0300; fax: 269–429–3852; e-mail: hq@asabe.org; Web site: <http://www.asabe.org/>:

(1) ASAE R313.1–1971, Soil Cone Penetrometer, reaffirmed 1975, IBR approved for § 1926.1002(e).

(l) The following material is available for purchase from the American Society of Mechanical Engineers (ASME), Three Park Avenue, New York, NY 10016; telephone: 1–800–843–2763; fax: 973–882–1717; e-mail: infocentral@asme.org; Web site: <http://www.asme.org/>:

(1) ASME B30.2–2005, Overhead and Gantry Cranes (Top Running Bridge, Single or Multiple Girder, Top Running Trolley Hoist), issued Dec. 30, 2005 (“ASME B30.2–2005”), IBR approved for § 1926.1438(b).

(2) ASME B30.5–2004, Mobile and Locomotive Cranes, issued Sept. 27, 2004 (“ASME B30.5–2004”), IBR approved for §§ 1926.1414(b); 1926.1414(e); 1926.1433(b).

(3) ASME B30.7–2001, Base-Mounted Drum Hoists, issued Jan. 21, 2002 (“ASME B30.7–2001”), IBR approved for § 1926.1436(e).

(4) ASME B30.14–2004, Side Boom Tractors, issued Sept. 20, 2004 (“ASME B30.14–2004”), IBR approved for § 1926.1440(c).

(5) ASME Boiler and Pressure Vessel Code, Section VIII, 1968, IBR approved for §§ 1926.152(i), 1926.306(a), and 1926.603(a).

(6) ASME Power Boilers, Section I, 1968, IBR approved for § 1926.603(a).

(m) The following material is available for purchase from the American Welding Society (AWS), 550 N.W. LeJeune Road, Miami, Florida 33126; telephone: 1–800–443–9353; Web site: <http://www.aws.org/>:

(1) AWS D1.1/D1.1M:2002, Structural Welding Code—Steel, 18th ed., ANSI approved Aug. 31, 2001 (“AWS D1.1/D1.1M:2002”), IBR approved for § 1926.1436(c).

(2) ANSI/AWS D14.3–94, Specification for Welding Earthmoving and Construction Equipment, ANSI approved Jun. 11, 1993 (“ANSI/AWS D14.3–94”), IBR approved for § 1926.1436(c).

(n) The following material is available for purchase from the British Standards

Institution (BSI), 389 Chiswick High Road, London, W4 4AL, United Kingdom; telephone: +44 20 8996 9001; fax: +44 20 8996 7001; e-mail: cservices@bsigroup.com; Web site: <http://www.bsigroup.com/>:

(1) BS EN 13000:2004, Cranes—Mobile Cranes, published Jan. 4, 2006 (“BS EN 13000:2004”), IBR approved for § 1926.1433(c).

(2) BS EN 14439:2006, Cranes—Safety—Tower Cranes, published Jan. 31, 2007 (“BS EN 14439:2006”), IBR approved for § 1926.1433(c).

(o) The following material is available for purchase from the Bureau of Reclamation, United States Department of the Interior, 1849 C Street, NW., Washington DC 20240; telephone: 202–208–4501; Web site: <http://www.usbr.gov/>:

(1) Safety and Health Regulations for Construction, Part II, Sept. 1971, IBR approved for § 1926.1000(f).

(p) The following material is available for purchase from the California Department of Industrial Relations, 455 Golden Gate Avenue, San Francisco CA 94102; telephone: (415) 703–5070; e-mail: info@dir.ca.gov; Web site: <http://www.dir.ca.gov/>:

(1) Construction Safety Orders, IBR approved for § 1926.1000(f).

(q) [Reserved.]

(r) [Reserved.]

(s) [Reserved.]

(t) [Reserved.]

(u) The following material is available for purchase from the Federal Highway Administration, United States Department of Transportation, 1200 New Jersey Ave., SE., Washington, DC 20590; telephone: 202–366–4000; Web site: <http://www.fhwa.dot.gov/>:

(1) Manual on Uniform Traffic Control Devices, Millennium Edition, Dec. 2000, IBR approved for §§ 1926.200(g), 1926.201(a), and 1926.202.

(v) The following material is available for purchase from the General Services Administration (GSA), 1800 F Street, NW., Washington, DC 20405; telephone: (202) 501–0800; Web site: <http://www.gsa.gov/>:

(1) QQ–P–416, Federal Specification Plating Cadmium (Electrodeposited), IBR approved for § 1926.104(e).

(w) The following material is available for purchase from the Institute of Makers of Explosives (IME), 1120 19th Street, NW., Suite 310, Washington, DC 20036; telephone: 202–429–9280; fax: 202–429–9280; e-mail: info@ime.org; Web site: <http://www.ime.org/>:

(1) IME Pub. No. 2, American Table of Distances for Storage of Explosives, Jun. 5, 1964, IBR approved for § 1926.914(a).

(2) IME Pub. No. 20, Radio Frequency Energy—A Potential Hazard in the Use

of Electric Blasting Caps, Mar. 1968, IBR approved for § 1926.900(k).

(x) The following material is available for purchase from the International Organization for Standardization (ISO), 1, ch. de la Voie-Creuse, Case postale 56, CH–1211 Geneva 20, Switzerland; telephone: +41 22 749 01 11; fax: +41 22 733 34 30; Web site: <http://www.iso.org/>:

(1) ISO 11660–1:2008(E), Cranes—Access, guards and restraints—Part 1: General, 2d ed., Feb. 15, 2008 (“ISO 11660–1:2008(E)”), IBR approved for § 1926.1423(c).

(2) ISO 11660–2:1994(E), Cranes—Access, guards and restraints—Part 2: Mobile cranes, 1994 (“ISO 11660–2:1994(E)”), IBR approved for § 1926.1423(c).

(3) ISO 11660–3:2008(E), Cranes—Access, guards and restraints—Part 3: Tower cranes, 2d ed., Feb. 15, 2008 (“ISO 11660–3:2008(E)”), IBR approved for § 1926.1423(c).

(y) The following material is available for purchase from the National Fire Protection Association (NFPA), 1 Batterymarch Park, Quincy, MA 02169; telephone: 617–770–3000; fax: 617–770–0700; Web site: <http://www.nfpa.org/>:

(1) NFPA 10A–1970, Maintenance and Use of Portable Fire Extinguishers, IBR approved for § 1926.150(c).

(2) NFPA 13–1969, Standard for the Installation of Sprinkler Systems, IBR approved for § 1926.152(d).

(3) NFPA 30–1969, The Flammable and Combustible Liquids Code, IBR approved for § 1926.152(c).

(4) NFPA 80–1970, Standard for Fire Doors and Windows, Class E or F Openings, IBR approved for § 1926.152(b).

(5) NFPA 251–1969, Standard Methods of Fire Test of Building Construction and Material, IBR approved for §§ 1926.152(b) and 1926.155(f).

(6) NFPA 385–1966, Standard for Tank Vehicles for Flammable and Combustible Liquids, IBR approved for § 1926.152(g).

(z) [Reserved.]

(aa) The following material is available for purchase from the Power Crane and Shovel Association (PCSA), 6737 W. Washington Street, Suite 2400, Milwaukee, WI 53214; telephone: 1–800–369–2310; fax: 414–272–1170; Web site: <http://www.aem.org/CBC/ProdSpec/PCSA/>:

(1) PCSA Std. No. 1, Mobile Crane and Excavator Standards, 1968, IBR approved for § 1926.602(b).

(2) PCSA Std. No. 2, Mobile Hydraulic Crane Standards, 1968 (“PCSA Std. No. 2 (1968)”), IBR approved for

§§ 1926.602(b), 1926.1433(a), and 1926.1501(a).

(3) PCSA Std. No. 3, Mobile Hydraulic Excavator Standards, 1969, IBR approved for § 1926.602(b).

(bb) [Reserved.]

(cc) [Reserved.]

(dd) The following material is available for purchase from the Society of Automotive Engineers (SAE), 400 Commonwealth Drive, Warrendale, PA 15096; telephone: 1-877-606-7323; fax: 724-776-0790; Web site: <http://www.sae.org/>:

(1) SAE 1970 Handbook, IBR approved for § 1926.602(b).

(2) SAE 1971 Handbook, IBR approved for § 1926.1001(h).

(3) SAE J166-1971, Trucks and Wagons, IBR approved for § 1926.602(a).

(4) SAE J168-1970, Protective Enclosures—Test Procedures and Performance Requirements, IBR approved for § 1926.1002(a).

(5) SAE J185 (reaf. May 2003), Access Systems for Off-Road Machines, reaffirmed May 2003 (“SAE J185 (May 1993)”), IBR approved for § 1926.1423(c).

(6) SAE J236-1971, Self-Propelled Graders, IBR approved for § 1926.602(a).

(7) SAE J237-1971, Front End Loaders and Dozers, IBR approved for § 126.602(a).

(8) SAE J319b-1971, Self-Propelled Scrapers, IBR approved for § 1926.602(a).

(9) SAE J320a-1971, Minimum Performance Criteria for Roll-Over Protective Structure for Rubber-Tired, Self-Propelled Scrapers, IBR approved for § 1926.1001(h).

(10) SAE J321a-1970, Fenders for Pneumatic-Tired Earthmoving Haulage Equipment, IBR approved for § 1926.602(a).

(11) SAE J333a-1970, Operator Protection for Agricultural and Light Industrial Tractors, IBR approved for § 1926.602(a).

(12) SAE J386-1969, Seat Belts for Construction Equipment, IBR approved for § 1926.602(a).

(13) SAE J394-1971, Minimum Performance Criteria for Roll-Over Protective Structure for Rubber-Tired Front End Loaders and Rubber-Tired Dozers, IBR approved for § 1926.1001(h).

(14) SAE J395-1971, Minimum Performance Criteria for Roll-Over Protective Structure for Crawler Tractors and Crawler-Type Loaders, IBR approved for § 1926.1001(h).

(15) SAE J396-1971, Minimum Performance Criteria for Roll-Over Protective Structure for Motor Graders, IBR approved for § 1926.1001(h).

(16) SAE J397-1969, Critical Zone Characteristics and Dimensions for

Operators of Construction and Industrial Machinery, IBR approved for § 1926.1001(f).

(17) SAE J743a-1964, Tractor Mounted Side Boom, 1964 (“SAE J743a-1964”), IBR approved for § 1926.1501(a).

(18) SAE J959-1966, Lifting Crane Wire-Rope Strength Factors, 1966 (“SAE J959-1966”), IBR approved for § 1926.1501(a).

(19) SAE J987 (rev. Jun. 2003), Lattice Boom Cranes—Method of Test, revised Jun. 2003 (“SAE J987 (Jun. 2003)”), IBR approved for § 1926.1433(c).

(20) SAE J1063 (rev. Nov. 1993), Cantilevered Boom Crane Structures—Method of Test, revised Nov. 1993 (“SAE J1063 (Nov. 1993)”), IBR approved for § 1926.1433(c).

(ee) The following material is available for purchase from the United States Army Corps of Engineers, 441 G Street, NW., Washington, DC 20314; telephone: 202-761-0011; e-mail: hq-publicaffairs@usace.army.mil; Web site: <http://www.usace.army.mil/>:

(1) EM-385-1-1, General Safety Requirements, Mar. 1967, IBR approved for § 1926.1000(f).

(ff) The following material is available for purchase from standards resellers such as the Document Center Inc., 111 Industrial Road, Suite 9, Belmont, CA 94002; telephone: 650-591-7600; fax: 650-591-7617; e-mail: info@document-center.com; Web site: <http://www.document-center.com/>:

(1) ANSI B15.1-1953 (R1958), Safety Code for Mechanical Power-Transmission Apparatus, revised 1958, IBR approved for §§ 1926.300(b)(2) and 1926.1501(a).

(2) ANSI B30.2.0-1967, Safety Code for Overhead and Gantry Cranes, approved May 4, 1967, IBR approved for § 1926.1501(d).

(3) ANSI B30.5-1968, Crawler, Locomotive, and Truck Cranes, approved Dec. 16, 1968, IBR approved for §§ 1926.1433(a), 1926.1501(a), and 1926.1501(b).

(4) ANSI B30.6-1969, Safety Code for Derricks, approved Dec. 18, 1967, IBR approved for § 1926.1501(e).

Subpart C—General Safety and Health Provisions

■ 3. The authority citation for subpart C of 29 CFR part 1926 is retained as follows:

Authority: Sec. 3704, Contract Work Hours and Safety Standards Act (40 U.S.C. 333); secs. 4, 6, and 8, Occupational Safety and Health Act of 1970 (29 U.S.C. 653, 655, 657); Secretary of Labor’s Order No. 12-71 (36 FR 8754), 8-76 (41 FR 25059), 9-83 (48 FR 35736), 6-96 (62 FR 111), or 5-2007 (72 FR 31160) as applicable; and 29 CFR part 1911.

§ 1926.31 [Reserved.]

■ 4. Section 1926.31 is removed and reserved.

Subpart L—Scaffolds

■ 5. The authority citation for subpart L of 29 CFR part 1926 is revised to read as follows:

Authority: Section 107, Contract Work Hours and Safety Standards Act (Construction Safety Act)(40 U.S.C. 333); Secs. 4, 6, 8, Occupational Safety and Health Act of 1970 (29 U.S.C. 653, 655, 657); Secretary of Labor’s Order Nos. 1-90 (55 FR 9033) and 5-2007 (72 FR 31159); and 29 CFR part 1911.

■ 6. Section 1926.450 is amended by revising paragraph (a) to read as follows:

§ 1926.450 Scope, application, and definitions applicable to this subpart.

(a) *Scope and application.* This subpart applies to all scaffolds used in workplaces covered by this part. It does not apply to crane or derrick suspended personnel platforms. The criteria for aerial lifts are set out exclusively in § 1926.453.

* * * * *

Subpart M—Fall Protection

■ 7. The authority citation for subpart M of 29 CFR part 1926 is revised to read as follows:

Authority: Section 3704 of the Contract Work Hours and Safety Standards Act (Construction Safety Act) (40 U.S.C. 3701); Sections 4, 6 and 8 of the Occupational Safety and Health Act of 1970 (29 U.S.C. 653, 655, 657); Secretary of Labor’s Order Nos. 1-90 (55 FR 9033), 6-96 (62 FR 111), 3-2000 (65 FR 50017), and 5-2007 (72 FR 31159); and 29 CFR part 1911.

■ 8. Section 1926.500 is amended by revising paragraph (a)(2)(ii), adding paragraph (a)(3)(v), and revising paragraph (a)(4), to read as follows:

§ 1926.500 Scope, application, and definitions applicable to this subpart.

(a) * * *

(2) * * *

(ii) Requirements relating to fall protection for employees working on cranes and derricks are provided in subpart CC of this part.

* * * * *

(3) * * *

(v) Criteria for steps, handholds, ladders, and grabrails/guardrails/railings required by subpart CC are provided in subpart CC. Sections 1926.502(a), (c) through (e), and (i) apply to activities covered under subpart CC unless otherwise stated in subpart CC. No other paragraphs of § 1926.502 apply to subpart CC.

* * * * *

(4) Section 1926.503 sets forth requirements for training in the installation and use of fall protection systems, except in relation to steel erection activities and the use of equipment covered by subpart CC.

Subpart DD—Cranes and Derricks Used in Demolition and Underground Construction

■ 9. New subpart DD, consisting of § 1926.1500 is added to read as follows:

Subpart DD—Cranes and Derricks Used in Demolition and Underground Construction

Authority: Section 3704 of the Contract Work Hours and Safety Standards Act (40 U.S.C. 3701); Sections 4, 6, and 8 of the Occupational Safety and Health Act of 1970 (29 U.S.C. 653, 655, 657); Secretary of Labor's Order Nos. 12-71 (36 FR 8754), 8-76 (41 FR 25059), or 9-83 (49 FR 35736), and 5-2007 (72 FR 31159).

§ 1926.1500 Scope.

This subpart applies only to employers engaged in demolition work covered by § 1926.856 and § 1926.858, and underground construction work covered by § 1926.800. This subpart applies in lieu of § 1926 subpart CC.

Subpart N—Cranes, Derricks, Hoists, Elevators, and Conveyors

■ 10. The authority citation for subpart N of 29 CFR part 1926 is revised to read as follows:

Authority: Section 3704 of the Contract Work Hours and Safety Standards Act (40 U.S.C. 3701); Sections 4, 6, and 8 of the Occupational Safety and Health Act of 1970 (29 U.S.C. 653, 655, 657); Secretary of Labor's Order Nos. 12-71 (36 FR 8754), 8-76 (41 FR 25059), or 9-83 (49 FR 35736), and 5-2007 (72 FR 31159).

■ 11. The heading to subpart N of 29 CFR part 1926 is revised to read as follows:

Subpart N—Helicopters, Hoists, Elevators, and Conveyors

* * * * *

§ 1926.550 [Redesignated as § 1926.1501]

■ 12. Section 1926.550 is redesignated as § 1926.1501 in subpart DD.

§ 1926.550 [Reserved]

■ 13. Section 1926.550 is reserved.

■ 14. Section 1926.553 is amended by adding paragraph (c) to read as follows:

§ 1926.553 Base-mounted drum hoists.

* * * * *

(c) This section does not apply to base-mounted drum hoists used in

conjunction with derricks. Base-mounted drum hoists used in conjunction with derricks must conform to § 1926.1436(e).

Subpart O—Motorized Vehicles, Mechanical Equipment, and Marine Operations

■ 15. The authority citation for subpart O of 29 CFR part 1926 is revised to read as follows:

Authority: Section 107, Construction Work Hours and Safety Standards Act (Construction Safety Act) (40 U.S.C. 333); Secs. 4, 6, 8, Occupational Safety and Health Act of 1970 (29 U.S.C. 653, 655, 657); Secretary of Labor's Order No. 12-71 (36 FR 8754), 8-76 (41 FR 25059), 9-83 (48 FR 35736), 1-90 (55 FR 9033), 6-96 (62 FR 111), or 5-2007 (72 FR 31159), as applicable. Section 1926.602 also issued under 29 CFR part 1911.

■ 16. Section 1926.600 is amended by revising paragraph (a)(6) to read as follows:

§ 1926.600 Equipment.

(a) *General Requirements.* * * *
(6) All equipment covered by this subpart shall comply with the following requirements when working or being moved in the vicinity of power lines or energized transmitters, except where electrical distribution and transmission lines have been deenergized and visibly grounded at point of work or where insulating barriers, not a part of or an attachment to the equipment or machinery, have been erected to prevent physical contact with the lines:

(i) For lines rated 50 kV or below, minimum clearance between the lines and any part of the crane or load shall be 10 feet;

(ii) For lines rated over 50 kV, minimum clearance between the lines and any part of the crane or load shall be 10 feet plus 0.4 inch for each 1 kV over 50 kV, or twice the length of the line insulator, but never less than 10 feet;

(iii) In transit with no load and boom lowered, the equipment clearance shall be a minimum of 4 feet for voltages less than 50 kV, and 10 feet for voltages over 50 kV, up to and including 345 kV, and 16 feet for voltages up to and including 750 kV;

(iv) A person shall be designated to observe clearance of the equipment and give timely warning for all operations where it is difficult for the operator to maintain the desired clearance by visual means;

(v) Cage-type boom guards, insulating links, or proximity warning devices may be used on cranes, but the use of such devices shall not alter the requirements of any other regulation of this part even

if such device is required by law or regulation;

(vi) Any overhead wire shall be considered to be an energized line unless and until the person owning such line or the electrical utility authorities indicate that it is not an energized line and it has been visibly grounded;

(vii) Prior to work near transmitter towers where an electrical charge can be induced in the equipment or materials being handled, the transmitter shall be de-energized or tests shall be made to determine if electrical charge is induced on the crane. The following precautions shall be taken when necessary to dissipate induced voltages:

(A) The equipment shall be provided with an electrical ground directly to the upper rotating structure supporting the boom; and

(B) Ground jumper cables shall be attached to materials being handled by boom equipment when electrical charge is induced while working near energized transmitters. Crews shall be provided with nonconductive poles having large alligator clips or other similar protection to attach the ground cable to the load.

(C) Combustible and flammable materials shall be removed from the immediate area prior to operations.

Subpart R—Steel Erection

■ 17. The authority citation for subpart R of 29 CFR part 1926 is revised to read as follows:

Authority: Section 3704 of the Contract Work Hours and Safety Standards Act (40 U.S.C. 3701); Sections 4, 6, and 8 of the Occupational Safety and Health Act of 1970 (29 U.S.C. 653, 655, 657); Secretary of Labor's Order Nos. 3-2000 (65 FR 50017), 5-2002 (67 FR 65008), and 5-2007 (72 FR 31159); and 29 CFR part 1911.

■ 18. Section 1926.753 is amended by revising paragraphs (a) and (c)(4) to read as follows:

§ 1926.753 Hoisting and rigging.

(a) All the provisions of subpart CC apply to hoisting and rigging with the exception of § 1926.1431(a).

* * * * *

(c) * * *

(4) Cranes or derricks may be used to hoist employees on a personnel platform when work under this subpart is being conducted, provided that all provisions of § 1926.1431 (except for § 1926.1431(a)) are met.

* * * * *

Subpart S—Underground Construction, Caissons, Cofferdams, and Compressed Air

■ 19. The authority citation for subpart S of 29 CFR part 1926 is revised to read as follows:

Authority: Sec. 107, Contract Work Hours and Safety Standards Act (40 U.S.C. 333); secs. 4, 6, and 8 of the Occupational Safety and Health Act of 1970 (29 U.S.C. 653, 655, 657); Secretary of Labor's Orders 12–71 (36 FR 8754), 8–76 (41 FR 25059), 9–83 (48 FR 35736), 1–90 (55 FR 9033), 6–96 (62 FR 111), or 5–2007 (72 FR 31159) as applicable.

■ 20. Section 1926.800 is amended by revising paragraph (t) to read as follows:

§ 1926.800 Underground construction.

(t) *Hoisting unique to underground construction.* Employers must comply with § 1926.1501(g) of § 1926 subpart DD. Except as modified by this paragraph (t), the following provisions of subpart N of this part apply: Requirements for material hoists are found in §§ 1926.552(a) and (b) of this part. Requirements for personnel hoists are found in the personnel hoists requirements of §§ 1926.552(a) and (c) of this part and in the elevator requirement of §§ 1926.552(a) and (d) of this part.

Subpart T—Demolition

■ 21. The authority citation for subpart S of 29 CFR part 1926 is revised to read as follows:

Authority: Sec. 107, Contract Work Hours and Safety Standards Act (40 U.S.C. 333); secs. 4, 6, and 8 of the Occupational Safety and Health Act of 1970 (29 U.S.C. 653, 655, 657); Secretary of Labor's Orders 12–71 (36 FR 8754), 8–76 (41 FR 25059), 9–83 (48 FR 35736), 1–90 (55 FR 9033), 6–96 (62 FR 111), or 5–2007 (72 FR 31159) as applicable.

■ 22. Section 1926.856 is amended by revising paragraph (c) to read as follows:

§ 1926.856 Removal of walls, floors, and material with equipment.

(c) Mechanical equipment used shall meet the requirements specified in subparts N and O and § 1926.1501 of § 1926 subpart DD.

■ 23. Section 1926.858 is amended by revising paragraph (b) to read as follows:

§ 1926.858 Removal of walls, floors, and material with equipment.

(b) Cranes, derricks, and other hoisting equipment used shall meet the requirements specified in § 1926.1501 of § 1926 subpart DD.

Subpart V—Power Transmission and Distribution

■ 24. The authority citation for subpart V of part 1926 is revised to read as follows:

Authority: Section 3704 of the Contract Work Hours and Safety Standards Act (40 U.S.C. 3701); Secs. 4, 6, and 8 of the Occupational Safety and Health Act of 1970 (29 U.S.C. 653, 655, 657); Secretary of Labor's Order Nos. 12–71 (36 FR 8754); 8–76 (41 FR 25059); 9–83 (48 FR 35736, 1–90 (55 FR 9033), and 5–2007 (72 FR 31159). Section 1926.951 also issued under 29 CFR part 1911.

■ 25. Section 1926.952 is amended by revising paragraph (c) to read as follows:

§ 1926.952 Mechanical equipment.

(c) *Cranes and other lifting equipment.*

(1) All equipment shall comply with subparts CC and O of this part, as applicable.

(2) Digger derricks used for augering holes for poles carrying electric lines, placing and removing poles, or for handling associated materials to be installed or removed from the poles must comply with 29 CFR 1910.269.

(3) With the exception of equipment certified for work on the proper voltage, mechanical equipment shall not be operated closer to any energized line or equipment than the clearances set forth in § 1926.950(c) unless, in addition to the requirements in § 1926.1410:

(i) The mechanical equipment is insulated, or

(ii) The mechanical equipment is considered as energized.

Note to paragraph (c)(3): In accordance with 29 CFR 1926.1400(g), compliance with 29 CFR 1910.269(p) will be deemed compliance with §§ 1926.1407 through 1926.1411, including § 1926.1410.

Subpart X—Stairways and Ladders

■ 26. The authority citation for subpart X of 29 CFR part 1926 is amended by revising paragraph (a) to read as follows:

Authority: Section 107, Contract Work Hours and Safety Standards Act (Construction Safety Act)(40 U.S.C. 333); Secs. 4, 6, 8, Occupational Safety and Health Act of 1970 (29 U.S.C. 653, 655, 657); Secretary of Labor's Order Nos. 1–90 (55 FR 9033), 5–2007 (72 FR 31159); and 29 CFR part 1911.

■ 27. Section 1926.1050 is amended by revising paragraph (a) to read as follows:

§ 1926.1050 Scope, application, and definitions applicable to this subpart.

(a) *Scope and application.* This subpart applies to all stairways and ladders used in construction, alteration, repair (including painting and

decorating), and demolition workplaces covered under 29 CFR part 1926, and also sets forth, in specified circumstances, when ladders and stairways are required to be provided. Additional requirements for ladders used on or with scaffolds are contained in subpart L—Scaffolds. This subpart does not apply to integral components of equipment covered by subpart CC. Subpart CC exclusively sets forth the circumstances when ladders and stairways must be provided on equipment covered by subpart CC.

Appendix A to Part 1926—Designations for General Industry Standards Incorporated into Body of Construction Standards

■ 28. Appendix A to part 1926 is amended by removing the row containing “1926.550(a)(19)” and “1910.184(c)(9)” from the table “1926 DESIGNATIONS FOR APPLICABLE 1910 STANDARDS.”

Subparts AA and BB—[Reserved]

■ 29. Subparts AA and BB are reserved and subpart CC is added to read as follows:

Subpart CC—Cranes and Derricks in Construction

Sec.	
1926.1400	Scope.
1926.1401	Definitions.
1926.1402	Ground conditions.
1926.1403	Assembly/Disassembly—selection of manufacturer or employer procedures.
1926.1404	Assembly/Disassembly—general requirements (applies to all assembly and disassembly operations).
1926.1405	Disassembly—additional requirements for dismantling of booms and jibs (applies to both the use of manufacturer procedures and employer procedures).
1926.1406	Assembly/Disassembly—employer procedures—general requirements.
1926.1407	Power line safety (up to 350 kV)—assembly and disassembly.
1926.1408	Power line safety (up to 350 kV)—equipment operations.
1926.1409	Power line safety (over 350 kV).
1926.1410	Power line safety (all voltages)—equipment operations closer than the Table A zone.
1926.1411	Power line safety—while traveling.
1926.1412	Inspections.
1926.1413	Wire rope—inspection.
1926.1414	Wire rope—selection and installation criteria.
1926.1415	Safety devices.
1926.1416	Operational aids.
1926.1417	Operation.
1926.1418	Authority to stop operation.
1926.1419	Signals—general requirements.

- 1926.1420 Signals—radio, telephone or other electronic transmission of signals.
- 1926.1421 Signals—voice signals—additional requirements.
- 1926.1422 Signals—hand signal chart.
- 1926.1423 Fall protection.
- 1926.1424 Work area control.
- 1926.1425 Keeping clear of the load.
- 1926.1426 Free fall and controlled load lowering.
- 1926.1427 Operator qualification and certification.
- 1926.1428 Signal person qualifications.
- 1926.1429 Qualifications of maintenance & repair employees.
- 1926.1430 Training.
- 1926.1431 Hoisting personnel.
- 1926.1432 Multiple-crane/derrick lifts—supplemental requirements.
- 1926.1433 Design, construction and testing.
- 1926.1434 Equipment modifications.
- 1926.1435 Tower cranes.
- 1926.1436 Derricks.
- 1926.1437 Floating cranes/derricks and land cranes/derricks on barges.
- 1926.1438 Overhead & gantry cranes.
- 1926.1439 Dedicated pile drivers.
- 1926.1440 Sideboom cranes.
- 1926.1441 Equipment with a rated hoisting/lifting capacity of 2,000 pounds or less.
- 1926.1442 Severability.
- Appendix A to Subpart CC of part 1926—Standard Hand Signals
- Appendix B to Subpart CC of part 1926—Assembly/Disassembly—Sample Procedures for Minimizing the Risk of Unintended Dangerous Boom Movement
- Appendix C to Subpart CC of part 1926—Operator Certification—Written Examination—Technical Knowledge Criteria

Subpart CC—Cranes and Derricks in Construction

Authority: Section 3704 of the Contract Work Hours and Safety Standards Act (40 U.S.C. 3701); sections 4, 6, and 8 of the Occupational Safety and Health Act of 1970 (29 U.S.C. 653, 655, 657); Secretary of Labor's Order No. 5–2007 (72 FR 31159); and 29 CFR part 1911.

§ 1926.1400 Scope.

(a) This standard applies to power-operated equipment, when used in construction, that can hoist, lower and horizontally move a suspended load. Such equipment includes, but is not limited to: Articulating cranes (such as knuckle-boom cranes); crawler cranes; floating cranes; cranes on barges; locomotive cranes; mobile cranes (such as wheel-mounted, rough-terrain, all-terrain, commercial truck-mounted, and boom truck cranes); multi-purpose machines when configured to hoist and lower (by means of a winch or hook) and horizontally move a suspended load; industrial cranes (such as carry-deck cranes); dedicated pile drivers; service/mechanic trucks with a hoisting device; a crane on a monorail; tower cranes (such as a fixed jib, *i.e.*,

“hammerhead boom”), luffing boom and self-erecting); pedestal cranes; portal cranes; overhead and gantry cranes; straddle cranes; sideboom cranes; derricks; and variations of such equipment. However, items listed in paragraph (c) of this section are excluded from the scope of this standard.

(b) *Attachments.* This standard applies to equipment included in paragraph (a) of this section when used with attachments. Such attachments, whether crane-attached or suspended include, but are not limited to: Hooks, magnets, grapples, clamshell buckets, orange peel buckets, concrete buckets, drag lines, personnel platforms, augers or drills and pile driving equipment.

(c) *Exclusions.* This subpart does not cover:

(1) Machinery included in paragraph (a) of this section while it has been converted or adapted for a non-hoisting/lifting use. Such conversions/adaptations include, but are not limited to, power shovels, excavators and concrete pumps.

(2) Power shovels, excavators, wheel loaders, backhoes, loader backhoes, track loaders. This machinery is also excluded when used with chains, slings or other rigging to lift suspended loads.

(3) Automotive wreckers and tow trucks when used to clear wrecks and haul vehicles.

(4) Digger derricks when used for augering holes for poles carrying electric and telecommunication lines, placing and removing the poles, and for handling associated materials to be installed on or removed from the poles. Digger derricks used in work subject to 29 CFR part 1926, subpart V, must comply with 29 CFR 1910.269. Digger derricks used in construction work for telecommunication service (as defined at 29 CFR 1910.268(s)(40)) must comply with 29 CFR 1910.268.

(5) Machinery originally designed as vehicle-mounted aerial devices (for lifting personnel) and self-propelled elevating work platforms.

(6) Telescopic/hydraulic gantry systems.

(7) Stacker cranes.

(8) Powered industrial trucks (forklifts), except when configured to hoist and lower (by means of a winch or hook) and horizontally move a suspended load.

(9) Mechanic's truck with a hoisting device when used in activities related to equipment maintenance and repair.

(10) Machinery that hoists by using a come-a-long or chainfall.

(11) Dedicated drilling rigs.

(12) Gin poles when used for the erection of communication towers.

(13) Tree trimming and tree removal work.

(14) Anchor handling or dredge-related operations with a vessel or barge using an affixed A-frame.

(15) Roustabouts.

(16) Helicopter cranes.

(17) *Material Delivery*

(i) Articulating/knuckle-boom truck cranes that deliver material to a construction site when used to transfer materials from the truck crane to the ground, without arranging the materials in a particular sequence for hoisting.

(ii) Articulating/knuckle-boom truck cranes that deliver material to a construction site when the crane is used to transfer building supply sheet goods or building supply packaged materials from the truck crane onto a structure, using a fork/cradle at the end of the boom, but only when the truck crane is equipped with a properly functioning automatic overload prevention device. Such sheet goods or packaged materials include, but are not limited to: Sheets of sheet rock, sheets of plywood, bags of cement, sheets or packages of roofing shingles, and rolls of roofing felt.

(iii) This exclusion does not apply when:

(A) The articulating/knuckle-boom crane is used to hold, support or stabilize the material to facilitate a construction activity, such as holding material in place while it is attached to the structure;

(B) The material being handled by the articulating/knuckle-boom crane is a prefabricated component. Such prefabricated components include, but are not limited to: Precast concrete members or panels, roof trusses (wooden, cold-formed metal, steel, or other material), prefabricated building sections such as, but not limited to: Floor panels, wall panels, roof panels, roof structures, or similar items;

(C) The material being handled by the crane is a structural steel member (for example, steel joists, beams, columns, steel decking (bundled or unbundled) or a component of a systems-engineered metal building (as defined in 29 CFR 1926 subpart R).

(D) The activity is not specifically excluded under § 1400(c)(17)(i) and (ii).

(d) All sections of this subpart CC apply to the equipment covered by this standard unless specified otherwise.

(e) The duties of controlling entities under this subpart include, but are not limited to, the duties specified in § 1926.1402(c), § 1926.1402(e) and § 1926.1424(b).

(f) Where provisions of this standard direct an operator, crewmember, or other employee to take certain actions, the employer must establish, effectively

communicate to the relevant persons, and enforce, work rules to ensure compliance with such provisions.

(g) For work covered by subpart V of this part, compliance with 29 CFR § 1910.269(p) is deemed compliance with §§ 1926.1407 through 1926.1411.

(h) Section 1926.1402 does not apply to cranes designed for use on railroad tracks, when used on railroad tracks that are part of the general railroad system of transportation that is regulated pursuant to the Federal Railroad Administration under 49 CFR part 213, and that comply with applicable Federal Railroad Administration requirements. See § 1926.1402(f).

§ 1926.1401 Definitions.

A/D director (Assembly/Disassembly director) means an individual who meets this subpart's requirements for an A/D director, irrespective of the person's formal job title or whether the person is non-management or management personnel.

Articulating crane means a crane whose boom consists of a series of folding, pin connected structural members, typically manipulated to extend or retract by power from hydraulic cylinders.

Assembly/Disassembly means the assembly and/or disassembly of equipment covered under this standard. With regard to tower cranes, "erecting and climbing" replaces the term "assembly," and "dismantling" replaces the term "disassembly." Regardless of whether the crane is initially erected to its full height or is climbed in stages, the process of increasing the height of the crane is an erection process.

Assist crane means a crane used to assist in assembling or disassembling a crane.

Attachments means any device that expands the range of tasks that can be done by the equipment. Examples include, but are not limited to: An auger, drill, magnet, pile-driver, and boom-attached personnel platform.

Audible signal means a signal made by a distinct sound or series of sounds. Examples include, but are not limited to, sounds made by a bell, horn, or whistle.

Blocking (also referred to as "cribbing") is wood or other material used to support equipment or a component and distribute loads to the ground. It is typically used to support lattice boom sections during assembly/disassembly and under outrigger and stabilizer floats.

Boatswain's chair means a single-point adjustable suspension scaffold consisting of a seat or sling (which may be incorporated into a full body harness)

designed to support one employee in a sitting position.

Bogie means "travel bogie," which is defined below.

Boom (equipment other than tower crane) means an inclined spar, strut, or other long structural member which supports the upper hoisting tackle on a crane or derrick. Typically, the length and vertical angle of the boom can be varied to achieve increased height or height and reach when lifting loads. Booms can usually be grouped into general categories of hydraulically extendible, cantilevered type, latticed section, cable supported type or articulating type.

Boom (tower cranes): On tower cranes, if the "boom" (i.e., principal horizontal structure) is fixed, it is referred to as a jib; if it is moveable up and down, it is referred to as a boom.

Boom angle indicator means a device which measures the angle of the boom relative to horizontal.

Boom hoist limiting device includes boom hoist disengaging device, boom hoist shut-off, boom hoist disconnect, boom hoist hydraulic relief, boom hoist kick-outs, automatic boom stop device, or derricking limiter. This type of device disengages boom hoist power when the boom reaches a predetermined operating angle. It also sets brakes or closes valves to prevent the boom from lowering after power is disengaged.

Boom length indicator indicates the length of the permanent part of the boom (such as ruled markings on the boom) or, as in some computerized systems, the length of the boom with extensions/attachments.

Boom stop includes boom stops, (belly straps with struts/standoff), telescoping boom stops, attachment boom stops, and backstops. These devices restrict the boom from moving above a certain maximum angle and toppling over backward.

Boom suspension system means a system of pendants, running ropes, sheaves, and other hardware which supports the boom tip and controls the boom angle.

Builder means the builder/constructor of equipment.

Center of gravity: The center of gravity of any object is the point in the object around which its weight is evenly distributed. If you could put a support under that point, you could balance the object on the support.

Certified welder means a welder who meets nationally recognized certification requirements applicable to the task being performed.

Climbing means the process in which a tower crane is raised to a new working height, either by adding additional

tower sections to the top of the crane (top climbing), or by a system in which the entire crane is raised inside the structure (inside climbing).

Come-a-long means a mechanical device typically consisting of a chain or cable attached at each end that is used to facilitate movement of materials through leverage.

Competent person means one who is capable of identifying existing and predictable hazards in the surroundings or working conditions which are unsanitary, hazardous, or dangerous to employees, and who has authorization to take prompt corrective measures to eliminate them.

Controlled load lowering means lowering a load by means of a mechanical hoist drum device that allows a hoisted load to be lowered with maximum control using the gear train or hydraulic components of the hoist mechanism. Controlled load lowering requires the use of the hoist drive motor, rather than the load hoist brake, to lower the load.

Controlling entity means an employer that is a prime contractor, general contractor, construction manager or any other legal entity which has the overall responsibility for the construction of the project—its planning, quality and completion.

Counterweight means a weight used to supplement the weight of equipment in providing stability for lifting loads by counterbalancing those loads.

Crane/derrick includes all equipment covered by this subpart.

Crawler crane means equipment that has a type of base mounting which incorporates a continuous belt of sprocket driven track.

Crossover points means locations on a wire rope which is spooled on a drum where one layer of rope climbs up on and crosses over the previous layer. This takes place at each flange of the drum as the rope is spooled onto the drum, reaches the flange, and begins to wrap back in the opposite direction.

Dedicated channel means a line of communication assigned by the employer who controls the communication system to only one signal person and crane/derrick or to a coordinated group of cranes/derricks/signal person(s).

Dedicated pile-driver is a machine that is designed to function exclusively as a pile-driver. These machines typically have the ability to both hoist the material that will be pile-driven and to pile-drive that material.

Dedicated spotter (power lines): To be considered a dedicated spotter, the requirements of § 1926.1428 (Signal person qualifications) must be met and

his/her sole responsibility is to watch the separation between the power line and the equipment, load line and load (including rigging and lifting accessories), and ensure through communication with the operator that the applicable minimum approach distance is not breached.

Directly under the load means a part or all of an employee is directly beneath the load.

Dismantling includes partial dismantling (such as dismantling to shorten a boom or substitute a different component).

Drum rotation indicator means a device on a crane or hoist which indicates in which direction and at what relative speed a particular hoist drum is turning.

Electrical contact occurs when a person, object, or equipment makes contact or comes in close proximity with an energized conductor or equipment that allows the passage of current.

Employer-made equipment means floating cranes/derricks designed and built by an employer for the employer's own use.

Encroachment is where any part of the crane, load line or load (including rigging and lifting accessories) breaches a minimum clearance distance that this subpart requires to be maintained from a power line.

Equipment means equipment covered by this subpart.

Equipment criteria means instructions, recommendations, limitations and specifications.

Fall protection equipment means guardrail systems, safety net systems, personal fall arrest systems, positioning device systems or fall restraint systems.

Fall restraint system means a fall protection system that prevents the user from falling any distance. The system is comprised of either a body belt or body harness, along with an anchorage, connectors and other necessary equipment. The other components typically include a lanyard, and may also include a lifeline and other devices.

Fall zone means the area (including but not limited to the area directly beneath the load) in which it is reasonably foreseeable that partially or completely suspended materials could fall in the event of an accident.

Flange points are points of contact between rope and drum flange where the rope changes layers.

Floating cranes/derricks means equipment designed by the manufacturer (or employer) for marine use by permanent attachment to a barge, pontoons, vessel or other means of flotation.

For example means "one example, although there are others."

Free fall (of the load line) means that only the brake is used to regulate the descent of the load line (the drive mechanism is not used to drive the load down faster or retard its lowering).

Free surface effect is the uncontrolled transverse movement of liquids in compartments which reduce a vessel's transverse stability.

Hoist means a mechanical device for lifting and lowering loads by winding a line onto or off a drum.

Hoisting is the act of raising, lowering or otherwise moving a load in the air with equipment covered by this standard. As used in this standard, "hoisting" can be done by means other than wire rope/hoist drum equipment.

Include/including means "including, but not limited to."

Insulating link/device means an insulating device listed, labeled, or accepted by a Nationally Recognized Testing Laboratory in accordance with 29 CFR 1910.7.

Jib stop (also referred to as a jib backstop), is the same type of device as a boom stop but is for a fixed or luffing jib.

Land crane/derrick is equipment not originally designed by the manufacturer for marine use by permanent attachment to barges, pontoons, vessels, or other means of flotation.

List means the angle of inclination about the longitudinal axis of a barge, pontoons, vessel or other means of flotation.

Load refers to the object(s) being hoisted and/or the weight of the object(s); both uses refer to the object(s) and the load-attaching equipment, such as, the load block, ropes, slings, shackles, and any other ancillary attachment.

Load moment (or rated capacity) indicator means a system which aids the equipment operator by sensing (directly or indirectly) the overturning moment on the equipment, *i.e.*, load multiplied by radius. It compares this lifting condition to the equipment's rated capacity, and indicates to the operator the percentage of capacity at which the equipment is working. Lights, bells, or buzzers may be incorporated as a warning of an approaching overload condition.

Load moment (or rated capacity) limiter means a system which aids the equipment operator by sensing (directly or indirectly) the overturning moment on the equipment, *i.e.*, load multiplied by radius. It compares this lifting condition to the equipment's rated capacity, and when the rated capacity is reached, it shuts off power to those

equipment functions which can increase the severity of loading on the equipment, *e.g.*, hoisting, telescoping out, or luffing out. Typically, those functions which decrease the severity of loading on the equipment remain operational, *e.g.*, lowering, telescoping in, or luffing in.

Locomotive crane means a crane mounted on a base or car equipped for travel on a railroad track.

Luffing jib limiting device is similar to a boom hoist limiting device, except that it limits the movement of the luffing jib.

Marine hoisted personnel transfer device means a device, such as a "transfer net," that is designed to protect the employees being hoisted during a marine transfer and to facilitate rapid entry into and exit from the device. Such devices do not include boatswain's chairs when hoisted by equipment covered by this standard.

Marine worksite means a construction worksite located in, on or above the water.

Mobile crane means a lifting device incorporating a cable suspended latticed boom or hydraulic telescopic boom designed to be moved between operating locations by transport over the road.

Moving point-to-point means the times during which an employee is in the process of going to or from a work station.

Multi-purpose machine means a machine that is designed to be configured in various ways, at least one of which allows it to hoist (by means of a winch or hook) and horizontally move a suspended load. For example, a machine that can rotate and can be configured with removable forks/tongs (for use as a forklift) or with a winch pack, jib (with a hook at the end) or jib used in conjunction with a winch.

When configured with the forks/tongs, it is not covered by this subpart. When configured with a winch pack, jib (with a hook at the end) or jib used in conjunction with a winch, it is covered by this subpart.

Nationally recognized accrediting agency is an organization that, due to its independence and expertise, is widely recognized as competent to accredit testing organizations. Examples of such accrediting agencies include, but are not limited to, the National Commission for Certifying Agencies and the American National Standards Institute.

Nonconductive means that, because of the nature and condition of the materials used, and the conditions of use (including environmental conditions and condition of the material), the object in question has the

property of not becoming energized (that is, it has high dielectric properties offering a high resistance to the passage of current under the conditions of use).

Operational aids are devices that assist the operator in the safe operation of the crane by providing information or automatically taking control of a crane function. These include, but are not limited to, the devices listed in § 1926.1416 ("listed operational aids").

Operational controls means levers, switches, pedals and other devices for controlling equipment operation.

Operator means a person who is operating the equipment.

Overhead and gantry cranes includes overhead/bridge cranes, semigantry, cantilever gantry, wall cranes, storage bridge cranes, launching gantry cranes, and similar equipment, irrespective of whether it travels on tracks, wheels, or other means.

Paragraph refers to a paragraph in the same section of this subpart that the word "paragraph" is used, unless otherwise specified.

Pendants includes both wire and bar types. Wire type: A fixed length of wire rope with mechanical fittings at both ends for pinning segments of wire rope together. Bar type: Instead of wire rope, a bar is used. Pendants are typically used in a latticed boom crane system to easily change the length of the boom suspension system without completely changing the rope on the drum when the boom length is increased or decreased.

Personal fall arrest system means a system used to arrest an employee in a fall from a working level. It consists of an anchorage, connectors, a body harness and may include a lanyard, deceleration device, lifeline, or suitable combination of these.

Portal crane is a type of crane consisting of a rotating upperstructure, hoist machinery, and boom mounted on top of a structural gantry which may be fixed in one location or have travel capability. The gantry legs or columns usually have portal openings in between to allow passage of traffic beneath the gantry.

Power lines means electric transmission and distribution lines.

Procedures include, but are not limited to: Instructions, diagrams, recommendations, warnings, specifications, protocols and limitations.

Proximity alarm is a device that provides a warning of proximity to a power line and that has been listed, labeled, or accepted by a Nationally Recognized Testing Laboratory in accordance with 29 CFR 1910.7.

Qualified evaluator (not a third party) means a person employed by the signal person's employer who has demonstrated that he/she is competent in accurately assessing whether individuals meet the Qualification Requirements in this subpart for a signal person.

Qualified evaluator (third party) means an entity that, due to its independence and expertise, has demonstrated that it is competent in accurately assessing whether individuals meet the Qualification Requirements in this subpart for a signal person.

Qualified person means a person who, by possession of a recognized degree, certificate, or professional standing, or who by extensive knowledge, training and experience, successfully demonstrated the ability to solve/resolve problems relating to the subject matter, the work, or the project.

Qualified rigger is a rigger who meets the criteria for a qualified person.

Range control limit device is a device that can be set by an equipment operator to limit movement of the boom or jib tip to a plane or multiple planes.

Range control warning device is a device that can be set by an equipment operator to warn that the boom or jib tip is at a plane or multiple planes.

Rated capacity means the maximum working load permitted by the manufacturer under specified working conditions. Such working conditions typically include a specific combination of factors such as equipment configuration, radii, boom length, and other parameters of use.

Rated capacity indicator: See load moment indicator.

Rated capacity limiter: See load moment limiter.

Repetitive pickup points refer to, when operating on a short cycle operation, the rope being used on a single layer and being spooled repetitively over a short portion of the drum.

Running wire rope means a wire rope that moves over sheaves or drums.

Runway means a firm, level surface designed, prepared and designated as a path of travel for the weight and configuration of the crane being used to lift and travel with the crane suspended platform. An existing surface may be used as long as it meets these criteria.

Section means a section of this subpart, unless otherwise specified.

Sideboom crane means a track-type or wheel-type tractor having a boom mounted on the side of the tractor, used for lifting, lowering or transporting a load suspended on the load hook. The

boom or hook can be lifted or lowered in a vertical direction only.

Special hazard warnings means warnings of site-specific hazards (for example, proximity of power lines).

Stability (floatation device) means the tendency of a barge, pontoons, vessel or other means of floatation to return to an upright position after having been inclined by an external force.

Standard Method means the protocol in Appendix A of this subpart for hand signals.

Such as means "such as, but not limited to."

Superstructure: See Upperworks.

Tagline means a rope (usually fiber) attached to a lifted load for purposes of controlling load spinning and pendular motions or used to stabilize a bucket or magnet during material handling operations.

Tender means an individual responsible for monitoring and communicating with a diver.

Tilt up or tilt down operation means raising/lowering a load from the horizontal to vertical or vertical to horizontal.

Tower crane is a type of lifting structure which utilizes a vertical mast or tower to support a working boom (jib) in an elevated position. Loads are suspended from the working boom. While the working boom may be of the fixed type (horizontal or angled) or have luffing capability, it can always rotate to swing loads, either by rotating on the top of the tower (top slewing) or by the rotation of the tower (bottom slewing). The tower base may be fixed in one location or ballasted and moveable between locations. Mobile cranes that are configured with luffing jib and/or tower attachments are not considered tower cranes under this section.

Travel bogie (tower cranes) is an assembly of two or more axles arranged to permit vertical wheel displacement and equalize the loading on the wheels.

Trim means angle of inclination about the transverse axis of a barge, pontoons, vessel or other means of floatation.

Two blocking means a condition in which a component that is uppermost on the hoist line such as the load block, hook block, overhaul ball, or similar component, comes in contact with the boom tip, fixed upper block or similar component. This binds the system and continued application of power can cause failure of the hoist rope or other component.

Unavailable procedures means procedures that are no longer available from the manufacturer, or have never been available, from the manufacturer.

Upperstructure: See Upperworks.

Upperworks means the revolving frame of equipment on which the operating machinery (and many cases the engine) are mounted along with the operator's cab. The counterweight is typically supported on the rear of the upperstructure and the boom or other front end attachment is mounted on the front.

Up to means "up to and including."

Wire rope means a flexible rope constructed by laying steel wires into various patterns of multi-wired strands around a core system to produce a helically wound rope.

§ 1926.1402 Ground conditions.

(a) *Definitions.*

(1) "Ground conditions" means the ability of the ground to support the equipment (including slope, compaction, and firmness).

(2) "Supporting materials" means blocking, mats, cribbing, marsh buggies (in marshes/wetlands), or similar supporting materials or devices.

(b) The equipment must not be assembled or used unless ground conditions are firm, drained, and graded to a sufficient extent so that, in conjunction (if necessary) with the use of supporting materials, the equipment manufacturer's specifications for adequate support and degree of level of the equipment are met. The requirement for the ground to be drained does not apply to marshes/wetlands.

(c) The controlling entity must:

(1) Ensure that ground preparations necessary to meet the requirements in paragraph (b) of this section are provided.

(2) Inform the user of the equipment and the operator of the location of hazards beneath the equipment set-up area (such as voids, tanks, utilities) if those hazards are identified in documents (such as site drawings, as-built drawings, and soil analyses) that are in the possession of the controlling entity (whether at the site or off-site) or the hazards are otherwise known to that controlling entity.

(d) If there is no controlling entity for the project, the requirement in paragraph (c)(1) of this section must be met by the employer that has authority at the site to make or arrange for ground preparations needed to meet paragraph (b) of this section.

(e) If the A/D director or the operator determines that ground conditions do not meet the requirements in paragraph (b) of this section, that person's employer must have a discussion with the controlling entity regarding the ground preparations that are needed so that, with the use of suitable supporting materials/devices (if necessary), the

requirements in paragraph (b) of this section can be met.

(f) This section does not apply to cranes designed for use on railroad tracks when used on railroad tracks that are part of the general railroad system of transportation that is regulated pursuant to the Federal Railroad Administration under 49 CFR part 213 and that comply with applicable Federal Railroad Administration requirements.

§ 1926.1403 Assembly/Disassembly—selection of manufacturer or employer procedures.

When assembling or disassembling equipment (or attachments), the employer must comply with all applicable manufacturer prohibitions and must comply with either:

(a) Manufacturer procedures applicable to assembly and disassembly, or

(b) Employer procedures for assembly and disassembly. Employer procedures may be used only where the employer can demonstrate that the procedures used meet the requirements in § 1926.1406. **Note:** The employer must follow manufacturer procedures when an employer uses synthetic slings during assembly or disassembly rigging. (See § 1926.1404(r).)

§ 1926.1404 Assembly/Disassembly—general requirements (applies to all assembly and disassembly operations).

(a) *Supervision—competent-qualified person.*

(1) Assembly/disassembly must be directed by a person who meets the criteria for both a competent person and a qualified person, or by a competent person who is assisted by one or more qualified persons ("A/D director").

(2) Where the assembly/disassembly is being performed by only one person, that person must meet the criteria for both a competent person and a qualified person. For purposes of this standard, that person is considered the A/D director.

(b) *Knowledge of procedures.* The A/D director must understand the applicable assembly/disassembly procedures.

(c) *Review of procedures.* The A/D director must review the applicable assembly/disassembly procedures immediately prior to the commencement of assembly/disassembly unless the A/D director understands the procedures and has applied them to the same type and configuration of equipment (including accessories, if any).

(d) *Crew instructions.*

(1) Before commencing assembly/disassembly operations, the A/D

director must ensure that the crew members understand all of the following:

(i) Their tasks.

(ii) The hazards associated with their tasks.

(iii) The hazardous positions/locations that they need to avoid.

(2) During assembly/disassembly operations, before a crew member takes on a different task, or when adding new personnel during the operations, the requirements in paragraphs (d)(1)(i) through (d)(1)(iii) of this section must be met.

(e) *Protecting assembly/disassembly crew members out of operator view.*

(1) Before a crew member goes to a location that is out of view of the operator and is either in, on, or under the equipment, or near the equipment (or load) where the crew member could be injured by movement of the equipment (or load), the crew member must inform the operator that he/she is going to that location.

(2) Where the operator knows that a crew member went to a location covered by paragraph (e)(1) of this section, the operator must not move any part of the equipment (or load) until the operator is informed in accordance with a pre-arranged system of communication that the crew member is in a safe position.

(f) *Working under the boom, jib or other components.*

(1) When pins (or similar devices) are being removed, employees must not be under the boom, jib, or other components, except where the requirements of paragraph (f)(2) of this section are met.

(2) *Exception.* Where the employer demonstrates that site constraints require one or more employees to be under the boom, jib, or other components when pins (or similar devices) are being removed, the A/D director must implement procedures that minimize the risk of unintended dangerous movement and minimize the duration and extent of exposure under the boom. (See Non-mandatory Appendix B of this subpart for an example.)

(g) *Capacity limits.* During all phases of assembly/disassembly, rated capacity limits for loads imposed on the equipment, equipment components (including rigging), lifting lugs and equipment accessories, must not be exceeded for the equipment being assembled/disassembled.

(h) *Addressing specific hazards.* The A/D director supervising the assembly/disassembly operation must address the hazards associated with the operation, which include:

(1) *Site and ground bearing conditions.* Site and ground conditions must be adequate for safe assembly/disassembly operations and to support the equipment during assembly/disassembly (see § 1926.1402 for ground condition requirements).

(2) *Blocking material.* The size, amount, condition and method of stacking the blocking must be sufficient to sustain the loads and maintain stability.

(3) *Proper location of blocking.* When used to support lattice booms or components, blocking must be appropriately placed to:

(i) Protect the structural integrity of the equipment, and
(ii) Prevent dangerous movement and collapse.

(4) *Verifying assist crane loads.* When using an assist crane, the loads that will be imposed on the assist crane at each phase of assembly/disassembly must be verified in accordance with § 1926.1417(o)(3) before assembly/disassembly begins.

(5) *Boom and jib pick points.* The point(s) of attachment of rigging to a boom (or boom sections or jib or jib sections) must be suitable for preventing structural damage and facilitating safe handling of these components.

(6) *Center of gravity.*

(i) The center of gravity of the load must be identified if that is necessary for the method used for maintaining stability.

(ii) Where there is insufficient information to accurately identify the center of gravity, measures designed to prevent unintended dangerous movement resulting from an inaccurate identification of the center of gravity must be used. (See Non-mandatory Appendix B of this subpart for an example.)

(7) *Stability upon pin removal.* The boom sections, boom suspension systems (such as gantry A-frames and jib struts), and components must be rigged or supported to maintain stability upon the removal of the pins.

(8) *Snagging.* Suspension ropes and pendants must not be allowed to catch on the boom or jib connection pins or cotter pins (including keepers and locking pins).

(9) *Struck by counterweights.* The potential for unintended movement from inadequately supported counterweights and from hoisting counterweights.

(10) *Boom hoist brake failure.* Each time reliance is to be placed on the boom hoist brake to prevent boom movement during assembly/disassembly, the brake must be tested prior to such reliance to determine if it

is sufficient to prevent boom movement. If it is not sufficient, a boom hoist pawl, other locking device/back-up braking device, or another method of preventing dangerous movement of the boom (such as blocking or using an assist crane) from a boom hoist brake failure must be used.

(11) *Loss of backward stability.* Backward stability before swinging the upperworks, travel, and when attaching or removing equipment components.

(12) *Wind speed and weather.* The effect of wind speed and weather on the equipment.

(i) [Reserved.]

(j) *Cantilevered boom sections.*

Manufacturer limitations on the maximum amount of boom supported only by cantilevering must not be exceeded. Where these are unavailable, a registered professional engineer familiar with the type of equipment involved must determine in writing this limitation, which must not be exceeded.

(k) *Weight of components.* The weight of each of the components must be readily available.

(l) [Reserved.]

(m) *Components and configuration.*

(1) The selection of components, and configuration of the equipment, that affect the capacity or safe operation of the equipment must be in accordance with:

(i) Manufacturer instructions, prohibitions, limitations, and specifications. Where these are unavailable, a registered professional engineer familiar with the type of equipment involved must approve, in writing, the selection and configuration of components; or

(ii) Approved modifications that meet the requirements of § 1926.1434 (Equipment modifications).

(2) *Post-assembly inspection.* Upon completion of assembly, the equipment must be inspected to ensure compliance with paragraph (m)(1) of this section (see § 1926.1412(c) for post-assembly inspection requirements).

(n) [Reserved.]

(o) *Shipping pins.* Reusable shipping pins, straps, links, and similar equipment must be removed. Once they are removed they must either be stowed or otherwise stored so that they do not present a falling object hazard.

(p) *Pile driving.* Equipment used for pile driving must not have a jib attached during pile driving operations.

(q) *Outriggers and Stabilizers.* When the load to be handled and the operating radius require the use of outriggers or stabilizers, or at any time when outriggers or stabilizers are used, all of the following requirements must be met (except as otherwise indicated):

(1) The outriggers or stabilizers must be either fully extended or, if manufacturer procedures permit, deployed as specified in the load chart.

(2) The outriggers must be set to remove the equipment weight from the wheels, except for locomotive cranes (see paragraph (q)(6) of this section for use of outriggers on locomotive cranes). This provision does not apply to stabilizers.

(3) When outrigger floats are used, they must be attached to the outriggers. When stabilizer floats are used, they must be attached to the stabilizers.

(4) Each outrigger or stabilizer must be visible to the operator or to a signal person during extension and setting.

(5) Outrigger and stabilizer blocking must:

(i) Meet the requirements in paragraphs (h)(2) and (h)(3) of this section.

(ii) Be placed only under the outrigger or stabilizer float/pad of the jack or, where the outrigger or stabilizer is designed without a jack, under the outer bearing surface of the extended outrigger or stabilizer beam.

(6) For locomotive cranes, when using outriggers or stabilizers to handle loads, the manufacturer's procedures must be followed. When lifting loads without using outriggers or stabilizers, the manufacturer's procedures must be met regarding truck wedges or screws.

(r) *Rigging.* In addition to following the requirements in 29 CFR 1926.251 and other requirements in this and other standards applicable to rigging, when rigging is used for assembly/disassembly, the employer must ensure that:

(1) The rigging work is done by a qualified rigger.

(2) Synthetic slings are protected from: Abrasive, sharp or acute edges, and configurations that could cause a reduction of the sling's rated capacity, such as distortion or localized compression. **Note:** Requirements for the protection of wire rope slings are contained in 29 CFR 1926.251(c)(9).

(3) When synthetic slings are used, the synthetic sling manufacturer's instructions, limitations, specifications and recommendations must be followed.

§ 1926.1405 Disassembly—additional requirements for dismantling of booms and jibs (applies to both the use of manufacturer procedures and employer procedures).

Dismantling (including dismantling for changing the length of) booms and jibs.

(a) None of the pins in the pendants are to be removed (partly or completely) when the pendants are in tension.

(b) None of the pins (top or bottom) on boom sections located between the pendant attachment points and the crane/derrick body are to be removed (partly or completely) when the pendants are in tension.

(c) None of the pins (top or bottom) on boom sections located between the uppermost boom section and the crane/derrick body are to be removed (partly or completely) when the boom is being supported by the uppermost boom section resting on the ground (or other support).

(d) None of the top pins on boom sections located on the cantilevered portion of the boom being removed (the portion being removed ahead of the pendant attachment points) are to be removed (partly or completely) until the cantilevered section to be removed is fully supported.

§ 1926.1406 Assembly/Disassembly—employer procedures—general requirements.

(a) When using employer procedures instead of manufacturer procedures for assembly/disassembly, the employer must ensure that the procedures:

(1) Prevent unintended dangerous movement, and prevent collapse, of any part of the equipment.

(2) Provide adequate support and stability of all parts of the equipment.

(3) Position employees involved in the assembly/disassembly operation so that their exposure to unintended movement or collapse of part or all of the equipment is minimized.

(b) *Qualified person.* Employer procedures must be developed by a qualified person.

§ 1926.1407 Power line safety (up to 350 kV)—assembly and disassembly.

(a) Before assembling or disassembling equipment, the employer must determine if any part of the equipment, load line, or load (including rigging and lifting accessories) could get, in the direction or area of assembly/disassembly, closer than 20 feet to a power line during the assembly/disassembly process. If so, the employer must meet the requirements in Option (1), Option (2), or Option (3) of this section, as follows:

(1) *Option (1)—Deenergize and ground.* Confirm from the utility owner/operator that the power line has been deenergized and visibly grounded at the worksite.

(2) *Option (2)—20 foot clearance.* Ensure that no part of the equipment, load line or load (including rigging and lifting accessories), gets closer than 20 feet to the power line by implementing the measures specified in paragraph (b) of this section.

(3) *Option (3)—Table A clearance.*

(i) Determine the line's voltage and the minimum clearance distance permitted under Table A (see § 1926.1408).

(ii) Determine if any part of the equipment, load line, or load (including rigging and lifting accessories), could get closer than the minimum clearance distance to the power line permitted under Table A (see § 1926.1408). If so, then the employer must follow the requirements in paragraph (b) of this section to ensure that no part of the equipment, load line, or load (including rigging and lifting accessories), gets closer to the line than the minimum clearance distance.

(b) *Preventing encroachment/electrocution.* Where encroachment precautions are required under Option (2), or Option (3) of this section, all of the following requirements must be met:

(1) Conduct a planning meeting with the Assembly/Disassembly director (A/D director), operator, assembly/disassembly crew and the other workers who will be in the assembly/disassembly area to review the location of the power line(s) and the steps that will be implemented to prevent encroachment/electrocution.

(2) If tag lines are used, they must be nonconductive.

(3) At least one of the following additional measures must be in place. The measure selected from this list must be effective in preventing encroachment.

The additional measures are:

(i) Use a dedicated spotter who is in continuous contact with the equipment operator. The dedicated spotter must:

(A) Be equipped with a visual aid to assist in identifying the minimum clearance distance. Examples of a visual aid include, but are not limited to: A clearly visible line painted on the ground; a clearly visible line of stanchions; a set of clearly visible line-of-sight landmarks (such as a fence post behind the dedicated spotter and a building corner ahead of the dedicated spotter).

(B) Be positioned to effectively gauge the clearance distance.

(C) Where necessary, use equipment that enables the dedicated spotter to communicate directly with the operator.

(D) Give timely information to the operator so that the required clearance distance can be maintained.

(ii) A proximity alarm set to give the operator sufficient warning to prevent encroachment.

(iii) A device that automatically warns the operator when to stop movement, such as a range control warning device. Such a device must be set to give the

operator sufficient warning to prevent encroachment.

(iv) A device that automatically limits range of movement, set to prevent encroachment.

(v) An elevated warning line, barricade, or line of signs, in view of the operator, equipped with flags or similar high-visibility markings.

(c) *Assembly/disassembly below power lines prohibited.* No part of a crane/derrick, load line, or load (including rigging and lifting accessories), whether partially or fully assembled, is allowed below a power line unless the employer has confirmed that the utility owner/operator has deenergized and (at the worksite) visibly grounded the power line.

(d) *Assembly/disassembly inside Table A clearance prohibited.* No part of a crane/derrick, load line, or load (including rigging and lifting accessories), whether partially or fully assembled, is allowed closer than the minimum approach distance under Table A (see § 1926.1408) to a power line unless the employer has confirmed that the utility owner/operator has deenergized and (at the worksite) visibly grounded the power line.

(e) *Voltage information.* Where Option (3) of this section is used, the utility owner/operator of the power lines must provide the requested voltage information within two working days of the employer's request.

(f) *Power lines presumed energized.* The employer must assume that all power lines are energized unless the utility owner/operator confirms that the power line has been and continues to be deenergized and visibly grounded at the worksite.

(g) *Posting of electrocution warnings.* There must be at least one electrocution hazard warning conspicuously posted in the cab so that it is in view of the operator and (except for overhead gantry and tower cranes) at least two on the outside of the equipment.

§ 1926.1408 Power line safety (up to 350 kV)—equipment operations.

(a) *Hazard assessments and precautions inside the work zone.* Before beginning equipment operations, the employer must:

(1) *Identify the work zone by either:*

(i) Demarcating boundaries (such as with flags, or a device such as a range limit device or range control warning device) and prohibiting the operator from operating the equipment past those boundaries, or

(ii) Defining the work zone as the area 360 degrees around the equipment, up to the equipment's maximum working radius.

(2) Determine if any part of the equipment, load line or load (including rigging and lifting accessories), if operated up to the equipment's maximum working radius in the work zone, could get closer than 20 feet to a power line. If so, the employer must meet the requirements in Option (1), Option (2), or Option (3) of this section, as follows:

(i) *Option (1)—Deenergize and ground.* Confirm from the utility owner/operator that the power line has been deenergized and visibly grounded at the worksite.

(ii) *Option (2)—20 foot clearance.* Ensure that no part of the equipment, load line, or load (including rigging and lifting accessories), gets closer than 20 feet to the power line by implementing the measures specified in paragraph (b) of this section.

(iii) *Option (3)—Table A clearance.*

(A) Determine the line's voltage and the minimum approach distance permitted under Table A (see § 1926.1408).

(B) Determine if any part of the equipment, load line or load (including rigging and lifting accessories), while operating up to the equipment's maximum working radius in the work zone, could get closer than the minimum approach distance of the power line permitted under Table A (see § 1926.1408). If so, then the employer must follow the requirements in paragraph (b) of this section to ensure that no part of the equipment, load line, or load (including rigging and lifting accessories), gets closer to the line than the minimum approach distance.

(b) *Preventing encroachment/electrocution.* Where encroachment precautions are required under Option (2) or Option (3) of this section, all of the following requirements must be met:

(1) Conduct a planning meeting with the operator and the other workers who will be in the area of the equipment or load to review the location of the power line(s), and the steps that will be implemented to prevent encroachment/electrocution.

(2) If tag lines are used, they must be non-conductive.

(3) Erect and maintain an elevated warning line, barricade, or line of signs, in view of the operator, equipped with flags or similar high-visibility markings, at 20 feet from the power line (if using Option (2) of this section) or at the minimum approach distance under Table A (see § 1926.1408) (if using Option (3) of this section). If the operator is unable to see the elevated warning line, a dedicated spotter must be used as described in

§ 1926.1408(b)(4)(ii) in addition to

implementing one of the measures described in §§ 1926.1408(b)(4)(i), (iii), (iv) and (v).

(4) Implement at least one of the following measures:

(i) A proximity alarm set to give the operator sufficient warning to prevent encroachment.

(ii) A dedicated spotter who is in continuous contact with the operator. Where this measure is selected, the dedicated spotter must:

(A) Be equipped with a visual aid to assist in identifying the minimum clearance distance. Examples of a visual aid include, but are not limited to: A clearly visible line painted on the ground; a clearly visible line of stanchions; a set of clearly visible line-of-sight landmarks (such as a fence post behind the dedicated spotter and a building corner ahead of the dedicated spotter).

(B) Be positioned to effectively gauge the clearance distance.

(C) Where necessary, use equipment that enables the dedicated spotter to communicate directly with the operator.

(D) Give timely information to the operator so that the required clearance distance can be maintained.

(iii) A device that automatically warns the operator when to stop movement, such as a range control warning device. Such a device must be set to give the operator sufficient warning to prevent encroachment.

(iv) A device that automatically limits range of movement, set to prevent encroachment.

(v) An insulating link/device, as defined in § 1926.1401, installed at a point between the end of the load line (or below) and the load.

(5) The requirements of paragraph (b)(4) of this section do not apply to work covered by subpart V of this part.

(c) *Voltage information.* Where Option (3) of this section is used, the utility owner/operator of the power lines must provide the requested voltage information within two working days of the employer's request.

(d) *Operations below power lines.*

(1) No part of the equipment, load line, or load (including rigging and lifting accessories) is allowed below a power line unless the employer has confirmed that the utility owner/operator has deenergized and (at the worksite) visibly grounded the power line, except where one of the exceptions in paragraph (d)(2) of this section applies.

(2) *Exceptions.* Paragraph (d)(1) of this section is inapplicable where the employer demonstrates that one of the following applies:

(i) The work is covered by subpart V of this part.

(ii) For equipment with non-extensible booms: The uppermost part of the equipment, with the boom at true vertical, would be more than 20 feet below the plane of the power line or more than the Table A of this section minimum clearance distance below the plane of the power line.

(iii) For equipment with articulating or extensible booms: The uppermost part of the equipment, with the boom in the fully extended position, at true vertical, would be more than 20 feet below the plane of the power line or more than the Table A of this section minimum clearance distance below the plane of the power line.

(iv) The employer demonstrates that compliance with paragraph (d)(1) of this section is infeasible and meets the requirements of § 1926.1410.

(e) *Power lines presumed energized.*

The employer must assume that all power lines are energized unless the utility owner/operator confirms that the power line has been and continues to be deenergized and visibly grounded at the worksite.

(f) When working near transmitter/communication towers where the equipment is close enough for an electrical charge to be induced in the equipment or materials being handled, the transmitter must be deenergized or the following precautions must be taken:

(1) The equipment must be provided with an electrical ground.

(2) If tag lines are used, they must be non-conductive.

(g) *Training.*

(1) The employer must train each operator and crew member assigned to work with the equipment on all of the following:

(i) The procedures to be followed in the event of electrical contact with a power line. Such training must include:

(A) Information regarding the danger of electrocution from the operator simultaneously touching the equipment and the ground.

(B) The importance to the operator's safety of remaining inside the cab except where there is an imminent danger of fire, explosion, or other emergency that necessitates leaving the cab.

(C) The safest means of evacuating from equipment that may be energized.

(D) The danger of the potentially energized zone around the equipment (step potential).

(E) The need for crew in the area to avoid approaching or touching the equipment and the load.

(F) Safe clearance distance from power lines.

(ii) Power lines are presumed to be energized unless the utility owner/

operator confirms that the power line has been and continues to be deenergized and visibly grounded at the worksite.

(iii) Power lines are presumed to be uninsulated unless the utility owner/operator or a registered engineer who is a qualified person with respect to electrical power transmission and distribution confirms that a line is insulated.

(iv) The limitations of an insulating link/device, proximity alarm, and range control (and similar) device, if used.

(v) The procedures to be followed to properly ground equipment and the limitations of grounding.

(2) Employees working as dedicated spotters must be trained to enable them to effectively perform their task, including training on the applicable requirements of this section.

(3) Training under this section must be administered in accordance with § 1926.1430(g).

(h) Devices originally designed by the manufacturer for use as: A safety device (see § 1926.1415), operational aid, or a means to prevent power line contact or electrocution, when used to comply with this section, must meet the manufacturer's procedures for use and conditions of use.

TABLE A—MINIMUM CLEARANCE DISTANCES

Voltage (nominal, kV, alternating current)	Minimum clearance distance (feet)
up to 50	10
over 50 to 200	15
over 200 to 350	20
over 350 to 500	25
over 500 to 750	35
over 750 to 1,000	45
over 1,000	(as established by the utility owner/operator or registered professional engineer who is a qualified person with respect to electrical power transmission and distribution).

Note: The value that follows “to” is up to and includes that value. For example, over 50 to 200 means up to and including 200kV.

§ 1926.1409 Power line safety (over 350 kV).

The requirements of § 1926.1407 and § 1926.1408 apply to power lines over 350 kV except:

(a) For power lines at or below 1000 kV, wherever the distance “20 feet” is specified, the distance “50 feet” must be substituted; and

(b) For power lines over 1000 kV, the minimum clearance distance must be established by the utility owner/operator or registered professional engineer who is a qualified person with respect to electrical power transmission and distribution.

§ 1926.1410 Power line safety (all voltages)—equipment operations closer than the Table A zone.

Equipment operations in which any part of the equipment, load line, or load (including rigging and lifting accessories) is closer than the minimum approach distance under Table A of § 1926.1408 to an energized power line is prohibited, except where the employer demonstrates that all of the following requirements are met:

(a) The employer determines that it is infeasible to do the work without breaching the minimum approach distance under Table A of § 1926.1408.

(b) The employer determines that, after consultation with the utility owner/operator, it is infeasible to deenergize and ground the power line or relocate the power line.

(c) *Minimum clearance distance.*

(1) The power line owner/operator or registered professional engineer who is

a qualified person with respect to electrical power transmission and distribution determines the minimum clearance distance that must be maintained to prevent electrical contact in light of the on-site conditions. The factors that must be considered in making this determination include, but are not limited to: Conditions affecting atmospheric conductivity; time necessary to bring the equipment, load line, and load (including rigging and lifting accessories) to a complete stop; wind conditions; degree of sway in the power line; lighting conditions, and other conditions affecting the ability to prevent electrical contact.

(2) Paragraph (c)(1) of this section does not apply to work covered by subpart V of this part; instead, for such work, the minimum clearance distances specified in § 1926.950 Table V-1 apply. Employers engaged in subpart V work are permitted to work closer than the distances in § 1926.950 Table V-1 where both the requirements of this section and § 1926.952(c)(3)(i) or (ii) are met.

(d) A planning meeting with the employer and utility owner/operator (or registered professional engineer who is a qualified person with respect to electrical power transmission and distribution) is held to determine the procedures that will be followed to prevent electrical contact and electrocution. At a minimum these procedures must include:

(1) If the power line is equipped with a device that automatically reenergizes the circuit in the event of a power line

contact, before the work begins, the automatic reclosing feature of the circuit interrupting device must be made inoperative if the design of the device permits.

(2) A dedicated spotter who is in continuous contact with the operator. The dedicated spotter must:

(i) Be equipped with a visual aid to assist in identifying the minimum clearance distance. Examples of a visual aid include, but are not limited to: A line painted on the ground; a clearly visible line of stanchions; a set of clearly visible line-of-sight landmarks (such as a fence post behind the dedicated spotter and a building corner ahead of the dedicated spotter).

(ii) Be positioned to effectively gauge the clearance distance.

(iii) Where necessary, use equipment that enables the dedicated spotter to communicate directly with the operator.

(iv) Give timely information to the operator so that the required clearance distance can be maintained.

(3) An elevated warning line, or barricade (not attached to the crane), in view of the operator (either directly or through video equipment), equipped with flags or similar high-visibility markings, to prevent electrical contact. However, this provision does not apply to work covered by subpart V of this part.

(4) *Insulating link/device.*

(i) An insulating link/device installed at a point between the end of the load line (or below) and the load.

(ii) For work covered by subpart V of this part, the requirement in paragraph

(d)(4)(i) of this section applies only when working inside the § 1926.950 Table V-1 clearance distances.

(iii) For work covered by subpart V of this part involving operations where use of an insulating link/device is infeasible, the requirements of § 1910.269(p)(4)(iii)(B) or (C) may be substituted for the requirement in (d)(4)(i) of this section.

(iv) Until November 8, 2011, the following procedure may be substituted for the requirement in paragraph (d)(4)(i) of this section: All employees, excluding equipment operators located on the equipment, who may come in contact with the equipment, the load line, or the load must be insulated or guarded from the equipment, the load line, and the load. Insulating gloves rated for the voltage involved are adequate insulation for the purposes of this paragraph.

(v) Until November 8, 2013, the following procedure may be substituted for the requirement in (d)(4)(i) of this section:

(A) The employer must use a link/device manufactured on or before November 8, 2011, that meets the definition of an insulating link/device, except that it has not been approved by a Nationally Recognized Testing Laboratory, and that is maintained and used in accordance with manufacturer requirements and recommendations, and is installed at a point between the end of the load line (or below) and the load; and

(B) All employees, excluding equipment operators located on the equipment, who may come in contact with the equipment, the load line, or the load must be insulated or guarded from the equipment, the load line, and the load through an additional means other than the device described in paragraph (d)(4)(v)(A) of this section. Insulating gloves rated for the voltage involved are adequate additional means of protection for the purposes of this paragraph.

(5) Nonconductive rigging if the rigging may be within the Table A of § 1926.1408 distance during the operation.

(6) If the equipment is equipped with a device that automatically limits range of movement, it must be used and set to prevent any part of the equipment, load line, or load (including rigging and lifting accessories) from breaching the minimum approach distance established under paragraph (c) of this section.

(7) If a tag line is used, it must be of the nonconductive type.

(8) Barricades forming a perimeter at least 10 feet away from the equipment

to prevent unauthorized personnel from entering the work area. In areas where obstacles prevent the barricade from being at least 10 feet away, the barricade must be as far from the equipment as feasible.

(9) Workers other than the operator must be prohibited from touching the load line above the insulating link/device and crane. Operators remotely operating the equipment from the ground must use either wireless controls that isolate the operator from the equipment or insulating mats that insulate the operator from the ground.

(10) Only personnel essential to the operation are permitted to be in the area of the crane and load.

(11) The equipment must be properly grounded.

(12) Insulating line hose or cover-up must be installed by the utility owner/operator except where such devices are unavailable for the line voltages involved.

(e) The procedures developed to comply with paragraph (d) of this section are documented and immediately available on-site.

(f) The equipment user and utility owner/operator (or registered professional engineer) meet with the equipment operator and the other workers who will be in the area of the equipment or load to review the procedures that will be implemented to prevent breaching the minimum approach distance established in paragraph (c) of this section and prevent electrocution.

(g) The procedures developed to comply with paragraph (d) of this section are implemented.

(h) The utility owner/operator (or registered professional engineer) and all employers of employees involved in the work must identify one person who will direct the implementation of the procedures. The person identified in accordance with this paragraph must direct the implementation of the procedures and must have the authority to stop work at any time to ensure safety.

(i) [Reserved.]

(j) If a problem occurs implementing the procedures being used to comply with paragraph (d) of this section, or indicating that those procedures are inadequate to prevent electrocution, the employer must safely stop operations and either develop new procedures to comply with paragraph (d) of this section or have the utility owner/operator deenergize and visibly ground or relocate the power line before resuming work.

(k) Devices originally designed by the manufacturer for use as a safety device (see § 1926.1415), operational aid, or a means to prevent power line contact or electrocution, when used to comply with this section, must comply with the manufacturer's procedures for use and conditions of use.

(l) [Reserved.]

(m) The employer must train each operator and crew member assigned to work with the equipment in accordance with § 1926.1408(g).

§ 1926.1411 Power line safety—while traveling under or near power lines with no load.

(a) This section establishes procedures and criteria that must be met for equipment traveling under or near a power line on a construction site with no load. Equipment traveling on a construction site with a load is governed by §§ 1926.1408, 1926.1409 or 1926.1410, whichever is appropriate, and § 1926.1417(u).

(b) The employer must ensure that:

(1) The boom/mast and boom/mast support system are lowered sufficiently to meet the requirements of this paragraph.

(2) The clearances specified in Table T of this section are maintained.

(3) The effects of speed and terrain on equipment movement (including movement of the boom/mast) are considered so that those effects do not cause the minimum clearance distances specified in Table T of this section to be breached.

(4) *Dedicated spotter.* If any part of the equipment while traveling will get closer than 20 feet to the power line, the employer must ensure that a dedicated spotter who is in continuous contact with the driver/operator is used. The dedicated spotter must:

(i) Be positioned to effectively gauge the clearance distance.

(ii) Where necessary, use equipment that enables the dedicated spotter to communicate directly with the operator.

(iii) Give timely information to the operator so that the required clearance distance can be maintained.

(5) *Additional precautions for traveling in poor visibility.* When traveling at night, or in conditions of poor visibility, in addition to the measures specified in paragraphs (b)(1) through (4) of this section, the employer must ensure that:

(i) The power lines are illuminated or another means of identifying the location of the lines is used.

(ii) A safe path of travel is identified and used.

TABLE T—MINIMUM CLEARANCE DISTANCES WHILE TRAVELING WITH NO LOAD

Voltage (nominal, kV, alternating current)	While traveling—minimum clearance distance (feet)
up to 0.75	4
over .75 to 50	6
over 50 to 345	10
over 345 to 750	16
Over 750 to 1,000	20
Over 1,000	(as established by the utility owner/operator or registered professional engineer who is a qualified person with respect to electrical power transmission and distribution).

§ 1926.1412 Inspections.

(a) Modified equipment.

(1) Equipment that has had modifications or additions which affect the safe operation of the equipment (such as modifications or additions involving a safety device or operational aid, critical part of a control system, power plant, braking system, load-sustaining structural components, load hook, or in-use operating mechanism) or capacity must be inspected by a qualified person after such modifications/additions have been completed, prior to initial use. The inspection must meet all of the following requirements:

(i) The inspection must assure that the modifications or additions have been done in accordance with the approval obtained pursuant to § 1926.1434 (Equipment modifications).

(ii) The inspection must include functional testing of the equipment.

(2) Equipment must not be used until an inspection under this paragraph demonstrates that the requirements of paragraph (a)(1)(i) of this section have been met.

(b) Repaired/adjusted equipment.

(1) Equipment that has had a repair or adjustment that relates to safe operation (such as: A repair or adjustment to a safety device or operator aid, or to a critical part of a control system, power plant, braking system, load-sustaining structural components, load hook, or in-use operating mechanism), must be inspected by a qualified person after such a repair or adjustment has been completed, prior to initial use. The inspection must meet all of the following requirements:

(i) The qualified person must determine if the repair/adjustment meets manufacturer equipment criteria (where applicable and available).

(ii) Where manufacturer equipment criteria are unavailable or inapplicable, the qualified person must:

(A) Determine if a registered professional engineer (RPE) is needed to develop criteria for the repair/adjustment. If an RPE is not needed, the

employer must ensure that the criteria are developed by the qualified person. If an RPE is needed, the employer must ensure that they are developed by an RPE.

(B) Determine if the repair/adjustment meets the criteria developed in accordance with paragraph (b)(1)(ii)(A) of this section.

(iii) The inspection must include functional testing of the repaired/adjusted parts and other components that may be affected by the repair/adjustment.

(4) Equipment must not be used until an inspection under this paragraph demonstrates that the repair/adjustment meets the requirements of paragraph (b)(1)(i) of this section (or, where applicable, paragraph (b)(1)(ii) of this section).

(c) Post-assembly.

(1) Upon completion of assembly, the equipment must be inspected by a qualified person to assure that it is configured in accordance with manufacturer equipment criteria.

(2) Where manufacturer equipment criteria are unavailable, a qualified person must:

(i) Determine if a registered professional engineer (RPE) familiar with the type of equipment involved is needed to develop criteria for the equipment configuration. If an RPE is not needed, the employer must ensure that the criteria are developed by the qualified person. If an RPE is needed, the employer must ensure that they are developed by an RPE.

(ii) Determine if the equipment meets the criteria developed in accordance with paragraph (c)(2)(i) of this section.

(3) Equipment must not be used until an inspection under this paragraph demonstrates that the equipment is configured in accordance with the applicable criteria.

(d) Each shift.

(1) A competent person must begin a visual inspection prior to each shift the equipment will be used, which must be completed before or during that shift. The inspection must consist of observation for apparent deficiencies.

Taking apart equipment components and booming down is not required as part of this inspection unless the results of the visual inspection or trial operation indicate that further investigation necessitating taking apart equipment components or booming down is needed. Determinations made in conducting the inspection must be reassessed in light of observations made during operation. At a minimum the inspection must include all of the following:

(i) Control mechanisms for maladjustments interfering with proper operation.

(ii) Control and drive mechanisms for apparent excessive wear of components and contamination by lubricants, water or other foreign matter.

(iii) Air, hydraulic, and other pressurized lines for deterioration or leakage, particularly those which flex in normal operation.

(iv) Hydraulic system for proper fluid level.

(v) Hooks and latches for deformation, cracks, excessive wear, or damage such as from chemicals or heat.

(vi) Wire rope reeving for compliance with the manufacturer's specifications.

(vii) Wire rope, in accordance with § 1926.1413(a).

(viii) Electrical apparatus for malfunctioning, signs of apparent excessive deterioration, dirt or moisture accumulation.

(ix) Tires (when in use) for proper inflation and condition.

(x) Ground conditions around the equipment for proper support, including ground settling under and around outriggers/stabilizers and supporting foundations, ground water accumulation, or similar conditions. This paragraph does not apply to the inspection of ground conditions for railroad tracks and their underlying support when the railroad tracks are part of the general railroad system of transportation that is regulated pursuant to the Federal Railroad Administration under 49 CFR part 213.

(xi) The equipment for level position within the tolerances specified by the

equipment manufacturer's recommendations, both before each shift and after each move and setup.

(xii) Operator cab windows for significant cracks, breaks, or other deficiencies that would hamper the operator's view.

(xiii) Rails, rail stops, rail clamps and supporting surfaces when the equipment has rail traveling. This paragraph does not apply to the inspection of rails, rail stops, rail clamps and supporting surfaces when the railroad tracks are part of the general railroad system of transportation that is regulated pursuant to the Federal Railroad Administration under 49 CFR part 213.

(xiv) Safety devices and operational aids for proper operation.

(2) If any deficiency in paragraphs (d)(1)(i) through (xiii) of this section (or in additional inspection items required to be checked for specific types of equipment in accordance with other sections of this standard) is identified, an immediate determination must be made by the competent person as to whether the deficiency constitutes a safety hazard. If the deficiency is determined to constitute a safety hazard, the equipment must be taken out of service until it has been corrected. *See* § 1926.1417.

(3) If any deficiency in paragraph (d)(1)(xiv) of this section (safety devices/operational aids) is identified, the action specified in § 1926.1415 and § 1926.1416 must be taken prior to using the equipment.

(e) *Monthly.*

(1) Each month the equipment is in service it must be inspected in accordance with paragraph (d) of this section (each shift).

(2) Equipment must not be used until an inspection under this paragraph demonstrates that no corrective action under paragraphs (d)(2) and (3) of this section is required.

(3) *Documentation.*

(i) The following information must be documented and maintained by the employer that conducts the inspection:

(A) The items checked and the results of the inspection.

(B) The name and signature of the person who conducted the inspection and the date.

(ii) This document must be retained for a minimum of three months.

(f) *Annual/comprehensive.*

(1) At least every 12 months the equipment must be inspected by a qualified person in accordance with paragraph (d) of this section (each shift) except that the corrective action set forth in paragraphs (f)(4), (f)(5), and (f)(6) of this section must apply in place

of the corrective action required by paragraphs (d)(2) and (d)(3) of this section.

(2) In addition, at least every 12 months, the equipment must be inspected by a qualified person. Disassembly is required, as necessary, to complete the inspection. The equipment must be inspected for all of the following:

(i) Equipment structure (including the boom and, if equipped, the jib):

(A) Structural members: Deformed, cracked, or significantly corroded.

(B) Bolts, rivets and other fasteners: loose, failed or significantly corroded.

(C) Welds for cracks.

(ii) Sheaves and drums for cracks or significant wear.

(iii) Parts such as pins, bearings, shafts, gears, rollers and locking devices for distortion, cracks or significant wear.

(iv) Brake and clutch system parts, linings, pawls and ratchets for excessive wear.

(v) Safety devices and operational aids for proper operation (including significant inaccuracies).

(vi) Gasoline, diesel, electric, or other power plants for safety-related problems (such as leaking exhaust and emergency shut-down feature) and conditions, and proper operation.

(vii) Chains and chain drive sprockets for excessive wear of sprockets and excessive chain stretch.

(viii) Travel steering, brakes, and locking devices, for proper operation.

(ix) Tires for damage or excessive wear.

(x) Hydraulic, pneumatic and other pressurized hoses, fittings and tubing, as follows:

(A) Flexible hose or its junction with the fittings for indications of leaks.

(B) Threaded or clamped joints for leaks.

(C) Outer covering of the hose for blistering, abnormal deformation or other signs of failure/impending failure.

(D) Outer surface of a hose, rigid tube, or fitting for indications of excessive abrasion or scrubbing.

(xi) Hydraulic and pneumatic pumps and motors, as follows:

(A) Performance indicators: Unusual noises or vibration, low operating speed, excessive heating of the fluid, low pressure.

(B) Loose bolts or fasteners.

(C) Shaft seals and joints between pump sections for leaks.

(xii) Hydraulic and pneumatic valves, as follows:

(A) Spools: Sticking, improper return to neutral, and leaks.

(B) Leaks.

(C) Valve housing cracks.

(D) Relief valves: Failure to reach correct pressure (if there is a

manufacturer procedure for checking pressure, it must be followed).

(xiii) Hydraulic and pneumatic cylinders, as follows:

(A) Drifting caused by fluid leaking across the piston.

(B) Rod seals and welded joints for leaks.

(C) Cylinder rods for scores, nicks, or dents.

(D) Case (barrel) for significant dents.

(E) Rod eyes and connecting joints: Loose or deformed.

(xiv) Outrigger or stabilizer pads/floats for excessive wear or cracks.

(xv) Slider pads for excessive wear or cracks.

(xvi) Electrical components and wiring for cracked or split insulation and loose or corroded terminations.

(xvii) Warning labels and decals originally supplied with the equipment by the manufacturer or otherwise required under this standard: Missing or unreadable.

(xviii) Originally equipped operator seat (or equivalent): Missing.

(xix) Operator seat: Unserviceable.

(xx) Originally equipped steps, ladders, handrails, guards: Missing.

(xxi) Steps, ladders, handrails, guards: In unusable/unsafe condition.

(3) This inspection must include functional testing to determine that the equipment as configured in the inspection is functioning properly.

(4) If any deficiency is identified, an immediate determination must be made by the qualified person as to whether the deficiency constitutes a safety hazard or, though not yet a safety hazard, needs to be monitored in the monthly inspections.

(5) If the qualified person determines that a deficiency is a safety hazard, the equipment must be taken out of service until it has been corrected, except when temporary alternative measures are implemented as specified in § 1926.1416(d) or § 1926.1435(e). *See* § 1926.1417.

(6) If the qualified person determines that, though not presently a safety hazard, the deficiency needs to be monitored, the employer must ensure that the deficiency is checked in the monthly inspections.

(7) *Documentation of annual/comprehensive inspection.* The following information must be documented, maintained, and retained for a minimum of 12 months, by the employer that conducts the inspection:

(i) The items checked and the results of the inspection.

(ii) The name and signature of the person who conducted the inspection and the date.

(g) *Severe service.* Where the severity of use/conditions is such that there is a

reasonable probability of damage or excessive wear (such as loading that may have exceeded rated capacity, shock loading that may have exceeded rated capacity, prolonged exposure to a corrosive atmosphere), the employer must stop using the equipment and a qualified person must:

(1) Inspect the equipment for structural damage to determine if the equipment can continue to be used safely.

(2) In light of the use/conditions determine whether any items/conditions listed in paragraph (f) of this section need to be inspected; if so, the qualified person must inspect those items/conditions.

(3) If a deficiency is found, the employer must follow the requirements in paragraphs (f)(4) through (6) of this section.

(h) *Equipment not in regular use.* Equipment that has been idle for 3 months or more must be inspected by a qualified person in accordance with the requirements of paragraph (e) (Monthly) of this section before initial use.

(i) [*Reserved.*]

(j) Any part of a manufacturer's procedures regarding inspections that relate to safe operation (such as to a safety device or operational aid, critical part of a control system, power plant, braking system, load-sustaining structural components, load hook, or in-use operating mechanism) that is more comprehensive or has a more frequent schedule of inspection than the requirements of this section must be followed.

(k) All documents produced under this section must be available, during the applicable document retention period, to all persons who conduct inspections under this section.

§ 1926.1413 Wire rope—inspection.

(a) *Shift inspection.*

(1) A competent person must begin a visual inspection prior to each shift the equipment is used, which must be completed before or during that shift. The inspection must consist of observation of wire ropes (running and standing) that are likely to be in use during the shift for apparent deficiencies, including those listed in paragraph (a)(2) of this section. Untwisting (opening) of wire rope or booming down is not required as part of this inspection.

(2) *Apparent deficiencies.*

(i) *Category I.* Apparent deficiencies in this category include the following:

(A) Significant distortion of the wire rope structure such as kinking, crushing, unstranding, birdcaging, signs

of core failure or steel core protrusion between the outer strands.

(B) Significant corrosion.

(C) Electric arc damage (from a source other than power lines) or heat damage.

(D) Improperly applied end connections.

(E) Significantly corroded, cracked, bent, or worn end connections (such as from severe service).

(ii) *Category II.* Apparent deficiencies in this category are:

(A) Visible broken wires, as follows:

(1) In running wire ropes: Six randomly distributed broken wires in one rope lay or three broken wires in one strand in one rope lay, where a rope lay is the length along the rope in which one strand makes a complete revolution around the rope.

(2) In rotation resistant ropes: Two randomly distributed broken wires in six rope diameters or four randomly distributed broken wires in 30 rope diameters.

(3) In pendants or standing wire ropes: More than two broken wires in one rope lay located in rope beyond end connections and/or more than one broken wire in a rope lay located at an end connection.

(B) A diameter reduction of more than 5% from nominal diameter.

(iii) *Category III.* Apparent deficiencies in this category include the following:

(A) In rotation resistant wire rope, core protrusion or other distortion indicating core failure.

(B) Prior electrical contact with a power line.

(C) A broken strand.

(3) *Critical review items.* The competent person must give particular attention to all of the following:

(i) Rotation resistant wire rope in use.

(ii) Wire rope being used for boom hoists and luffing hoists, particularly at reverse bends.

(iii) Wire rope at flange points, crossover points and repetitive pickup points on drums.

(iv) Wire rope at or near terminal ends.

(v) Wire rope in contact with saddles, equalizer sheaves or other sheaves where rope travel is limited.

(4) *Removal from service.*

(i) If a deficiency in Category I (see paragraph (a)(2)(i) of this section) is identified, an immediate determination must be made by the competent person as to whether the deficiency constitutes a safety hazard. If the deficiency is determined to constitute a safety hazard, operations involving use of the wire rope in question must be prohibited until:

(A) The wire rope is replaced (see § 1926.1417), or

(B) If the deficiency is localized, the problem is corrected by severing the wire rope in two; the undamaged portion may continue to be used. Joining lengths of wire rope by splicing is prohibited. If a rope is shortened under this paragraph, the employer must ensure that the drum will still have two wraps of wire when the load and/or boom is in its lowest position.

(ii) If a deficiency in Category II (see paragraph (a)(2)(ii) of this section) is identified, operations involving use of the wire rope in question must be prohibited until:

(A) The employer complies with the wire rope manufacturer's established criterion for removal from service or a different criterion that the wire rope manufacturer has approved in writing for that specific wire rope (see § 1926.1417).

(B) The wire rope is replaced (see § 1926.1417), or

(C) If the deficiency is localized, the problem is corrected by severing the wire rope in two; the undamaged portion may continue to be used. Joining lengths of wire rope by splicing is prohibited. If a rope is shortened under this paragraph, the employer must ensure that the drum will still have two wraps of wire when the load and/or boom is in its lowest position.

(iii) If a deficiency in Category III is identified, operations involving use of the wire rope in question must be prohibited until:

(A) The wire rope is replaced (see § 1926.1417), or

(B) If the deficiency (other than power line contact) is localized, the problem is corrected by severing the wire rope in two; the undamaged portion may continue to be used. Joining lengths of wire rope by splicing is prohibited. Repair of wire rope that contacted an energized power line is also prohibited. If a rope is shortened under this paragraph, the employer must ensure that the drum will still have two wraps of wire when the load and/or boom is in its lowest position.

(iv) Where a wire rope is required to be removed from service under this section, either the equipment (as a whole) or the hoist with that wire rope must be tagged-out, in accordance with § 1926.1417(f)(1), until the wire rope is repaired or replaced.

(b) *Monthly inspection.*

(1) Each month an inspection must be conducted in accordance with paragraph (a) (shift inspection) of this section.

(2) The inspection must include any deficiencies that the qualified person who conducts the annual inspection

determines under paragraph (c)(3)(ii) of this section must be monitored.

(3) Wire ropes on equipment must not be used until an inspection under this paragraph demonstrates that no corrective action under paragraph (a)(4) of this section is required.

(4) The inspection must be documented according to § 1926.1412(e)(3) (monthly inspection documentation).

(c) *Annual/comprehensive.*

(1) At least every 12 months, wire ropes in use on equipment must be inspected by a qualified person in accordance with paragraph (a) of this section (shift inspection).

(2) In addition, at least every 12 months, the wire ropes in use on equipment must be inspected by a qualified person, as follows:

(i) The inspection must be for deficiencies of the types listed in paragraph (a)(2) of this section.

(ii) The inspection must be complete and thorough, covering the surface of the entire length of the wire ropes, with particular attention given to all of the following:

(A) Critical review items listed in paragraph (a)(3) of this section.

(B) Those sections that are normally hidden during shift and monthly inspections.

(C) Wire rope subject to reverse bends.

(D) Wire rope passing over sheaves.

(iii) *Exception:* In the event an inspection under paragraph (c)(2) of this section is not feasible due to existing set-up and configuration of the equipment (such as where an assist crane is needed) or due to site conditions (such as a dense urban setting), such inspections must be conducted as soon as it becomes feasible, but no longer than an additional 6 months for running ropes and, for standing ropes, at the time of disassembly.

(3) If a deficiency is identified, an immediate determination must be made by the qualified person as to whether the deficiency constitutes a safety hazard.

(i) If the deficiency is determined to constitute a safety hazard, operations involving use of the wire rope in question must be prohibited until:

(A) The wire rope is replaced (*see* § 1926.1417), or

(B) If the deficiency is localized, the problem is corrected by severing the wire rope in two; the undamaged portion may continue to be used. Joining lengths of wire rope by splicing is prohibited. If a rope is shortened under this paragraph, the employer must ensure that the drum will still have two wraps of wire when the load and/or boom is in its lowest position.

(ii) If the qualified person determines that, though not presently a safety hazard, the deficiency needs to be monitored, the employer must ensure that the deficiency is checked in the monthly inspections.

(4) The inspection must be documented according to § 1926.1412(f)(7) (annual/comprehensive inspection documentation).

(d) Rope lubricants that are of the type that hinder inspection must not be used.

(e) All documents produced under this section must be available, during the applicable document retention period, to all persons who conduct inspections under this section.

§ 1926.1414 Wire rope—selection and installation criteria.

(a) Original equipment wire rope and replacement wire rope must be selected and installed in accordance with the requirements of this section. Selection of replacement wire rope must be in accordance with the recommendations of the wire rope manufacturer, the equipment manufacturer, or a qualified person.

(b) *Wire rope design criteria:* Wire rope (other than rotation resistant rope) must comply with either Option (1) or Option (2) of this section, as follows:

(1) *Option (1).* Wire rope must comply with section 5–1.7.1 of ASME B30.5–2004 (incorporated by reference, *see* § 1926.6) except that section's paragraph (c) must not apply.

(2) *Option (2).* Wire rope must be designed to have, in relation to the equipment's rated capacity, a sufficient minimum breaking force and design factor so that compliance with the applicable inspection provisions in § 1926.1413 will be an effective means of preventing sudden rope failure.

(c) Wire rope must be compatible with the safe functioning of the equipment.

(d) *Boom hoist reeving.*

(1) Fiber core ropes must not be used for boom hoist reeving, except for derricks.

(2) Rotation resistant ropes must be used for boom hoist reeving only where the requirements of paragraph (e)(4)(ii) of this section are met.

(e) *Rotation resistant ropes.*

(1) *Definitions.*

(i) *Type I rotation resistant wire rope ("Type I").* Type I rotation resistant rope is stranded rope constructed to have little or no tendency to rotate or, if guided, transmits little or no torque. It has at least 15 outer strands and comprises an assembly of at least three layers of strands laid helically over a center in two operations. The direction of lay of the outer strands is opposite to that of the underlying layer.

(ii) *Type II rotation resistant wire rope ("Type II").* Type II rotation resistant rope is stranded rope constructed to have significant resistance to rotation. It has at least 10 outer strands and comprises an assembly of two or more layers of strands laid helically over a center in two or three operations. The direction of lay of the outer strands is opposite to that of the underlying layer.

(iii) *Type III rotation resistant wire rope ("Type III").* Type III rotation resistant rope is stranded rope constructed to have limited resistance to rotation. It has no more than nine outer strands, and comprises an assembly of two layers of strands laid helically over a center in two operations. The direction of lay of the outer strands is opposite to that of the underlying layer.

(2) *Requirements.*

(i) Types II and III with an operating design factor of less than 5 must not be used for duty cycle or repetitive lifts.

(ii) Rotation resistant ropes (including Types I, II and III) must have an operating design factor of no less than 3.5.

(iii) Type I must have an operating design factor of no less than 5, except where the wire rope manufacturer and the equipment manufacturer approves the design factor, in writing.

(iv) Types II and III must have an operating design factor of no less than 5, except where the requirements of paragraph (e)(3) of this section are met.

(3) When Types II and III with an operating design factor of less than 5 are used (for non-duty cycle, non-repetitive lifts), the following requirements must be met for each lifting operation:

(i) A qualified person must inspect the rope in accordance with § 1926.1413(a). The rope must be used only if the qualified person determines that there are no deficiencies constituting a hazard. In making this determination, more than one broken wire in any one rope lay must be considered a hazard.

(ii) Operations must be conducted in such a manner and at such speeds as to minimize dynamic effects.

(iii) Each lift made under § 1926.1414(e)(3) must be recorded in the monthly and annual inspection documents. Such prior uses must be considered by the qualified person in determining whether to use the rope again.

(4) *Additional requirements for rotation resistant ropes for boom hoist reeving.*

(i) Rotation resistant ropes must not be used for boom hoist reeving, except where the requirements of paragraph (e)(4)(ii) of this section are met.

(ii) Rotation resistant ropes may be used as boom hoist reeving when load hoists are used as boom hoists for attachments such as luffing attachments or boom and mast attachment systems. Under these conditions, all of the following requirements must be met:

(A) The drum must provide a first layer rope pitch diameter of not less than 18 times the nominal diameter of the rope used.

(B) The requirements in § 1926.1426(a) (irrespective of the date of manufacture of the equipment), and § 1926.1426(b).

(C) The requirements in ASME B30.5–2004 sections 5–1.3.2(a), (a)(2) through (a)(4), (b) and (d) (incorporated by reference, *see* § 1926.6) except that the minimum pitch diameter for sheaves used in multiple rope reeving is 18 times the nominal diameter of the rope used (instead of the value of 16 specified in section 5–1.3.2(d)).

(D) All sheaves used in the boom hoist reeving system must have a rope pitch diameter of not less than 18 times the nominal diameter of the rope used.

(E) The operating design factor for the boom hoist reeving system must be not less than five.

(F) The operating design factor for these ropes must be the total minimum breaking force of all parts of rope in the system divided by the load imposed on the rope system when supporting the static weights of the structure and the load within the equipment's rated capacity.

(G) When provided, a power-controlled lowering system must be capable of handling rated capacities and speeds as specified by the manufacturer.

(f) Wire rope clips used in conjunction with wedge sockets must be attached to the unloaded dead end of the rope only, except that the use of devices specifically designed for dead-ending rope in a wedge socket is permitted.

(g) Socketing must be done in the manner specified by the manufacturer of the wire rope or fitting.

(h) Prior to cutting a wire rope, seizings must be placed on each side of the point to be cut. The length and number of seizings must be in accordance with the wire rope manufacturer's instructions.

§ 1926.1415 Safety devices.

(a) *Safety devices.* The following safety devices are required on all equipment covered by this subpart, unless otherwise specified:

(1) *Crane level indicator.*

(i) The equipment must have a crane level indicator that is either built into the equipment or is available on the equipment.

(ii) If a built-in crane level indicator is not working properly, it must be tagged-out or removed. If a removable crane level indicator is not working properly, it must be removed.

(iii) This requirement does not apply to portal cranes, derricks, floating cranes/derricks and land cranes/derricks on barges, pontoons, vessels or other means of flotation.

(2) Boom stops, except for derricks and hydraulic booms.

(3) Jib stops (if a jib is attached), except for derricks.

(4) Equipment with foot pedal brakes must have locks.

(5) Hydraulic outrigger jacks and hydraulic stabilizer jacks must have an integral holding device/check valve.

(6) Equipment on rails must have rail clamps and rail stops, except for portal cranes.

(7) *Horn*

(i) The equipment must have a horn that is either built into the equipment or is on the equipment and immediately available to the operator.

(ii) If a built-in horn is not working properly, it must be tagged-out or removed. If a removable horn is not working properly, it must be removed.

(b) *Proper operation required.* Operations must not begin unless all of the devices listed in this section are in proper working order. If a device stops working properly during operations, the operator must safely stop operations. If any of the devices listed in this section are not in proper working order, the equipment must be taken out of service and operations must not resume until the device is again working properly. *See* § 1926.1417 (Operation). Alternative measures are not permitted to be used.

§ 1926.1416 Operational aids.

(a) The devices listed in this section ("listed operational aids") are required on all equipment covered by this subpart, unless otherwise specified.

(1) The requirements in paragraphs (e)(1), (e)(2), and (e)(3) of this section do not apply to articulating cranes.

(2) The requirements in paragraphs (d)(3), (e)(1), and (e)(4) of this section apply only to those digger derricks manufactured after November 8, 2011.

(b) Operations must not begin unless the listed operational aids are in proper working order, except where an operational aid is being repaired the employer uses the specified temporary alternative measures. The time periods permitted for repairing defective operational aids are specified in paragraphs (d) and (e) of this section. More protective alternative measures specified by the crane/derrick manufacturer, if any, must be followed.

(c) If a listed operational aid stops working properly during operations, the operator must safely stop operations until the temporary alternative measures are implemented or the device is again working properly. If a replacement part is no longer available, the use of a substitute device that performs the same type of function is permitted and is not considered a modification under § 1926.1434.

(d) *Category I operational aids and alternative measures.* Operational aids listed in this paragraph that are not working properly must be repaired no later than 7 calendar days after the deficiency occurs. *Exception:* If the employer documents that it has ordered the necessary parts within 7 calendar days of the occurrence of the deficiency, the repair must be completed within 7 calendar days of receipt of the parts. *See* § 1926.1417(j) for additional requirements.

(1) *Boom hoist limiting device.*

(i) For equipment manufactured after December 16, 1969, a boom hoist limiting device is required. *Temporary alternative measures (use at least one).* One or more of the following methods must be used:

(A) Use a boom angle indicator.

(B) Clearly mark the boom hoist cable (so that it can easily be seen by the operator) at a point that will give the operator sufficient time to stop the hoist to keep the boom within the minimum allowable radius. In addition, install mirrors or remote video cameras and displays if necessary for the operator to see the mark.

(C) Clearly mark the boom hoist cable (so that it can easily be seen by a spotter) at a point that will give the spotter sufficient time to signal the operator and have the operator stop the hoist to keep the boom within the minimum allowable radius.

(ii) If the equipment was manufactured on or before December 16, 1969, and is not equipped with a boom hoist limiting device, at least one of the measures in paragraphs (d)(1)(i)(A) through (C) of this section must be used.

(2) *Luffing jib limiting device.*

Equipment with a luffing jib must have a luffing jib limiting device. Temporary alternative measures are the same as in paragraph (d)(1)(i) of this section, except to limit the movement of the luffing jib rather than the boom hoist.

(3) *Anti two-blocking device.*

(i) Telescopic boom cranes manufactured after February 28, 1992, must be equipped with a device which automatically prevents damage from contact between the load block, overhaul ball, or similar component, and the boom tip (or fixed upper block

or similar component). The device(s) must prevent such damage at all points where two-blocking could occur.

Temporary alternative measures:

Clearly mark the cable (so that it can easily be seen by the operator) at a point that will give the operator sufficient time to stop the hoist to prevent two-blocking, and use a spotter when extending the boom.

(ii) *Lattice boom cranes.*

(A) Lattice boom cranes manufactured after Feb 28, 1992, must be equipped with a device that either automatically prevents damage and load failure from contact between the load block, overhaul ball, or similar component, and the boom tip (or fixed upper block or similar component), or warns the operator in time for the operator to prevent two-blocking. The device must prevent such damage/failure or provide adequate warning for all points where two-blocking could occur.

(B) Lattice boom cranes and derricks manufactured after November 8, 2011 must be equipped with a device which automatically prevents damage and load failure from contact between the load block, overhaul ball, or similar component, and the boom tip (or fixed upper block or similar component). The device(s) must prevent such damage/failure at all points where two-blocking could occur.

(C) *Exception.* The requirements in paragraphs (d)(3)(ii)(A) and (B) of this section do not apply to such lattice boom equipment when used for dragline, clamshell (grapple), magnet, drop ball, container handling, concrete bucket, marine operations that do not involve hoisting personnel, and pile driving work.

(D) *Temporary alternative measures.*

Clearly mark the cable (so that it can easily be seen by the operator) at a point that will give the operator sufficient time to stop the hoist to prevent two-blocking, or use a spotter.

(iii) Articulating cranes manufactured after December 31, 1999, that are equipped with a load hoist must be equipped with a device that automatically prevents damage from contact between the load block, overhaul ball, or similar component, and the boom tip (or fixed upper block or similar component). The device must prevent such damage at all points where two-blocking could occur. *Temporary alternative measures:* When two-blocking could only occur with movement of the load hoist, clearly mark the cable (so that it can easily be seen by the operator) at a point that will give the operator sufficient time to stop the hoist to prevent two-blocking, or use a spotter. When two-blocking could

occur without movement of the load hoist, clearly mark the cable (so that it can easily be seen by the operator) at a point that will give the operator sufficient time to stop the hoist to prevent two-blocking, and use a spotter when extending the boom.

(e) *Category II operational aids and alternative measures.* Operational aids listed in this paragraph that are not working properly must be repaired no later than 30 calendar days after the deficiency occurs. *Exception:* If the employer documents that it has ordered the necessary parts within 7 calendar days of the occurrence of the deficiency, and the part is not received in time to complete the repair in 30 calendar days, the repair must be completed within 7 calendar days of receipt of the parts. See § 1926.1417(j) for additional requirements.

(1) *Boom angle or radius indicator.*

The equipment must have a boom angle or radius indicator readable from the operator's station. *Temporary alternative measures:* Radii or boom angle must be determined by measuring the radii or boom angle with a measuring device.

(2) Jib angle indicator if the equipment has a luffing jib. *Temporary alternative measures:* Radii or jib angle must be determined by ascertaining the main boom angle and then measuring the radii or jib angle with a measuring device.

(3) Boom length indicator if the equipment has a telescopic boom, except where the rated capacity is independent of the boom length. *Temporary alternative measures.* One or more of the following methods must be used:

- (i) Mark the boom with measured marks to calculate boom length,
- (ii) Calculate boom length from boom angle and radius measurements,
- (iii) Measure the boom with a measuring device.

(4) *Load weighing and similar devices.*

(i) Equipment (other than derricks and articulating cranes) manufactured after March 29, 2003 with a rated capacity over 6,000 pounds must have at least one of the following: load weighing device, load moment (or rated capacity) indicator, or load moment (or rated capacity) limiter. *Temporary alternative measures:* The weight of the load must be determined from a source recognized by the industry (such as the load's manufacturer) or by a calculation method recognized by the industry (such as calculating a steel beam from measured dimensions and a known per foot weight). This information must be provided to the operator prior to the lift.

(ii) Articulating cranes manufactured after November 8, 2011 must have at least one of the following: automatic overload prevention device, load weighing device, load moment (or rated capacity) indicator, or load moment (rated capacity) limiter. *Temporary alternative measures:* The weight of the load must be determined from a source recognized by the industry (such as the load's manufacturer) or by a calculation method recognized by the industry (such as calculating a steel beam from measured dimensions and a known per foot weight). This information must be provided to the operator prior to the lift.

(5) The following devices are required on equipment manufactured after November 8, 2011:

(i) Outrigger/stabilizer position (horizontal beam extension) sensor/monitor if the equipment has outriggers or stabilizers. *Temporary alternative measures:* The operator must verify that the position of the outriggers or stabilizers is correct (in accordance with manufacturer procedures) before beginning operations requiring outrigger or stabilizer deployment.

(ii) Hoist drum rotation indicator if the equipment has a hoist drum not visible from the operator's station. *Temporary alternative measures:* Mark the drum to indicate the rotation of the drum. In addition, install mirrors or remote video cameras and displays if necessary for the operator to see the mark.

§ 1926.1417 Operation.

(a) The employer must comply with all manufacturer procedures applicable to the operational functions of equipment, including its use with attachments.

(b) *Unavailable operation procedures.*

(1) Where the manufacturer procedures are unavailable, the employer must develop and ensure compliance with all procedures necessary for the safe operation of the equipment and attachments.

(2) Procedures for the operational controls must be developed by a qualified person.

(3) Procedures related to the capacity of the equipment must be developed and signed by a registered professional engineer familiar with the equipment.

(c) *Accessibility of procedures.*

(1) The procedures applicable to the operation of the equipment, including rated capacities (load charts), recommended operating speeds, special hazard warnings, instructions, and operator's manual, must be readily available in the cab at all times for use by the operator.

(2) Where rated capacities are available in the cab only in electronic form: In the event of a failure which makes the rated capacities inaccessible, the operator must immediately cease operations or follow safe shut-down procedures until the rated capacities (in electronic or other form) are available.

(d) The operator must not engage in any practice or activity that diverts his/her attention while actually engaged in operating the equipment, such as the use of cellular phones (other than when used for signal communications).

(e) *Leaving the equipment unattended.*

(1) The operator must not leave the controls while the load is suspended, except where all of the following are met:

(i) The operator remains adjacent to the equipment and is not engaged in any other duties.

(ii) The load is to be held suspended for a period of time exceeding normal lifting operations.

(iii) The competent person determines that it is safe to do so and implements measures necessary to restrain the boom hoist and telescoping, load, swing, and outrigger or stabilizer functions.

(iv) Barricades or caution lines, and notices, are erected to prevent all employees from entering the fall zone. No employees, including those listed in §§ 1926.1425(b)(1) through (3), § 1926.1425(d) or § 1926.1425(e), are permitted in the fall zone.

(2) The provisions in § 1926.1417(e)(1) do not apply to working gear (such as slings, spreader bars, ladders, and welding machines) where the weight of the working gear is negligible relative to the lifting capacity of the equipment as positioned, and the working gear is suspended over an area other than an entrance or exit.

(f) *Tag-out.*

(1) *Tagging out of service equipment/functions.* Where the employer has taken the equipment out of service, a tag must be placed in the cab stating that the equipment is out of service and is not to be used. Where the employer has taken a function(s) out of service, a tag must be placed in a conspicuous position stating that the function is out of service and is not to be used.

(2) *Response to "do not operate"/tag-out signs.*

(i) If there is a warning (tag-out or maintenance/do not operate) sign on the equipment or starting control, the operator must not activate the switch or start the equipment until the sign has been removed by a person authorized to remove it, or until the operator has verified that:

(A) No one is servicing, working on, or otherwise in a dangerous position on the machine.

(B) The equipment has been repaired and is working properly.

(ii) If there is a warning (tag-out or maintenance/do not operate) sign on any other switch or control, the operator must not activate that switch or control until the sign has been removed by a person authorized to remove it, or until the operator has verified that the requirements in paragraphs (f)(2)(i)(A) and (B) of this section have been met.

(g) Before starting the engine, the operator must verify that all controls are in the proper starting position and that all personnel are in the clear.

(h) *Storm warning.* When a local storm warning has been issued, the competent person must determine whether it is necessary to implement manufacturer recommendations for securing the equipment.

(i) *[Reserved.]*

(j) If equipment adjustments or repairs are necessary:

(1) The operator must, in writing, promptly inform the person designated by the employer to receive such information and, where there are successive shifts, to the next operator; and

(2) The employer must notify all affected employees, at the beginning of each shift, of the necessary adjustments or repairs and all alternative measures.

(k) Safety devices and operational aids must not be used as a substitute for the exercise of professional judgment by the operator.

(l) *[Reserved.]*

(m) If the competent person determines that there is a slack rope condition requiring re-spooling of the rope, it must be verified (before starting to lift) that the rope is seated on the drum and in the sheaves as the slack is removed.

(n) The competent person must adjust the equipment and/or operations to address the effect of wind, ice, and snow on equipment stability and rated capacity.

(o) *Compliance with rated capacity.*

(1) The equipment must not be operated in excess of its rated capacity.

(2) The operator must not be required to operate the equipment in a manner that would violate paragraph (o)(1) of this section.

(3) *Load weight.* The operator must verify that the load is within the rated capacity of the equipment by at least one of the following methods:

(i) The weight of the load must be determined from a source recognized by the industry (such as the load's manufacturer), or by a calculation

method recognized by the industry (such as calculating a steel beam from measured dimensions and a known per foot weight), or by other equally reliable means. In addition, when requested by the operator, this information must be provided to the operator prior to the lift; or

(ii) The operator must begin hoisting the load to determine, using a load weighing device, load moment indicator, rated capacity indicator, or rated capacity limiter, if it exceeds 75 percent of the maximum rated capacity at the longest radius that will be used during the lift operation. If it does, the operator must not proceed with the lift until he/she verifies the weight of the load in accordance with paragraph (o)(3)(i) of this section.

(p) The boom or other parts of the equipment must not contact any obstruction.

(q) The equipment must not be used to drag or pull loads sideways.

(r) On wheel-mounted equipment, no loads must be lifted over the front area, except as permitted by the manufacturer.

(s) The operator must test the brakes each time a load that is 90% or more of the maximum line pull is handled by lifting the load a few inches and applying the brakes. In duty cycle and repetitive lifts where each lift is 90% or more of the maximum line pull, this requirement applies to the first lift but not to successive lifts.

(t) Neither the load nor the boom must be lowered below the point where less than two full wraps of rope remain on their respective drums.

(u) *Traveling with a load.*

(1) Traveling with a load is prohibited if the practice is prohibited by the manufacturer.

(2) Where traveling with a load, the employer must ensure that:

(i) A competent person supervises the operation, determines if it is necessary to reduce rated capacity, and makes determinations regarding load position, boom location, ground support, travel route, overhead obstructions, and speed of movement necessary to ensure safety.

(ii) The determinations of the competent person required in paragraph (u)(2)(i) of this section are implemented.

(iii) For equipment with tires, tire pressure specified by the manufacturer is maintained.

(v) Rotational speed of the equipment must be such that the load does not swing out beyond the radius at which it can be controlled.

(w) A tag or restraint line must be used if necessary to prevent rotation of the load that would be hazardous.

(x) The brakes must be adjusted in accordance with manufacturer procedures to prevent unintended movement.

(y) The operator must obey a stop (or emergency stop) signal, irrespective of who gives it.

(z) *Swinging locomotive cranes.* A locomotive crane must not be swung into a position where railway cars on an adjacent track could strike it, until it is determined that cars are not being moved on the adjacent track and that proper flag protection has been established.

(aa) *Counterweight/ballast.*

(1) The following applies to equipment other than tower cranes:

(i) Equipment must not be operated without the counterweight or ballast in place as specified by the manufacturer.

(ii) The maximum counterweight or ballast specified by the manufacturer for the equipment must not be exceeded.

(2) Counterweight/ballast requirements for tower cranes are specified in § 1926.1435(b)(8).

§ 1926.1418 Authority to stop operation.

Whenever there is a concern as to safety, the operator must have the authority to stop and refuse to handle loads until a qualified person has determined that safety has been assured.

§ 1926.1419 Signals—general requirements.

(a) A signal person must be provided in each of the following situations:

(1) The point of operation, meaning the load travel or the area near or at load placement, is not in full view of the operator.

(2) When the equipment is traveling, the view in the direction of travel is obstructed.

(3) Due to site specific safety concerns, either the operator or the person handling the load determines that it is necessary.

(b) *Types of signals.* Signals to operators must be by hand, voice, audible, or new signals.

(c) *Hand signals.*

(1) When using hand signals, the Standard Method must be used (*see* Appendix A of this subpart). *Exception:* Where use of the Standard Method for hand signals is infeasible, or where an operation or use of an attachment is not covered in the Standard Method, non-standard hand signals may be used in accordance with paragraph (c)(2) of this section.

(2) *Non-standard hand signals.* When using non-standard hand signals, the signal person, operator, and lift director (where there is one) must contact each other prior to the operation and agree on

the non-standard hand signals that will be used.

(d) *New signals.* Signals other than hand, voice, or audible signals may be used where the employer demonstrates that:

(1) The new signals provide at least equally effective communication as voice, audible, or Standard Method hand signals, or

(2) The new signals comply with a national consensus standard that provides at least equally effective communication as voice, audible, or Standard Method hand signals.

(e) *Suitability.* The signals used (hand, voice, audible, or new), and means of transmitting the signals to the operator (such as direct line of sight, video, radio, *etc.*), must be appropriate for the site conditions.

(f) During operations requiring signals, the ability to transmit signals between the operator and signal person must be maintained. If that ability is interrupted at any time, the operator must safely stop operations requiring signals until it is reestablished and a proper signal is given and understood.

(g) If the operator becomes aware of a safety problem and needs to communicate with the signal person, the operator must safely stop operations. Operations must not resume until the operator and signal person agree that the problem has been resolved.

(h) Only one person may give signals to a crane/derrick at a time, except in circumstances covered by paragraph (j) of this section.

(i) [*Reserved.*]

(j) Anyone who becomes aware of a safety problem must alert the operator or signal person by giving the stop or emergency stop signal. (**Note:** § 1926.1417(y) requires the operator to obey a stop or emergency stop signal).

(k) All directions given to the operator by the signal person must be given from the operator's direction perspective.

(l) [*Reserved.*]

(m) *Communication with multiple cranes/derricks.* Where a signal person(s) is in communication with more than one crane/derrick, a system must be used for identifying the crane/derrick each signal is for, as follows:

(1) for each signal, prior to giving the function/direction, the signal person must identify the crane/derrick the signal is for, or

(2) must use an equally effective method of identifying which crane/derrick the signal is for.

§ 1926.1420 Signals—radio, telephone or other electronic transmission of signals.

(a) The device(s) used to transmit signals must be tested on site before

beginning operations to ensure that the signal transmission is effective, clear, and reliable.

(b) Signal transmission must be through a dedicated channel, except:

(1) Multiple cranes/derricks and one or more signal persons may share a dedicated channel for the purpose of coordinating operations.

(2) Where a crane is being operated on or adjacent to railroad tracks, and the actions of the crane operator need to be coordinated with the movement of other equipment or trains on the same or adjacent tracks.

(c) The operator's reception of signals must be by a hands-free system.

§ 1926.1421 Signals—voice signals—additional requirements.

(a) Prior to beginning operations, the operator, signal person and lift director (if there is one), must contact each other and agree on the voice signals that will be used. Once the voice signals are agreed upon, these workers need not meet again to discuss voice signals unless another worker is added or substituted, there is confusion about the voice signals, or a voice signal is to be changed.

(b) Each voice signal must contain the following three elements, given in the following order: function (such as hoist, boom, *etc.*), direction; distance and/or speed; function, stop command.

(c) The operator, signal person and lift director (if there is one), must be able to effectively communicate in the language used.

§ 1926.1422 Signals—hand signal chart.

Hand signal charts must be either posted on the equipment or conspicuously posted in the vicinity of the hoisting operations.

§ 1926.1423 Fall protection.

(a) *Application.*

(1) Paragraphs (b), (c)(3), (e) and (f) of this section apply to all equipment covered by this subpart except tower cranes.

(2) Paragraphs (c)(1), (c)(2), (d), (g), (j) and (k) of this section apply to all equipment covered by this subpart.

(3) Paragraphs (c)(4) and (h) of this section apply only to tower cranes.

(b) *Boom walkways.*

(1) Equipment manufactured after November 8, 2011 with lattice booms must be equipped with walkways on the boom(s) if the vertical profile of the boom (from cord centerline to cord centerline) is 6 or more feet.

(2) *Boom walkway criteria.*

(i) The walkways must be at least 12 inches wide.

(ii) Guardrails, railings and other permanent fall protection attachments along walkways are:

(A) Not required.

(B) Prohibited on booms supported by pendant ropes or bars if the guardrails/railings/attachments could be snagged by the ropes or bars.

(C) Prohibited if of the removable type (designed to be installed and removed each time the boom is assembled/disassembled).

(D) Where not prohibited, guardrails or railings may be of any height up to, but not more than, 45 inches.

(c) *Steps, handholds, ladders, grabrails, guardrails and railings.*

(1) Section 1926.502(b) does not apply to equipment covered by this subpart.

(2) The employer must maintain in good condition originally-equipped steps, handholds, ladders and guardrails/railings/grabrails.

(3) Equipment manufactured after November 8, 2011 must be equipped so as to provide safe access and egress between the ground and the operator work station(s), including the forward and rear positions, by the provision of devices such as steps, handholds, ladders, and guardrails/railings/grabrails. These devices must meet the following criteria:

(i) Steps, handholds, ladders and guardrails/railings/grabrails must meet the criteria of SAE J185 (May 2003) (incorporated by reference, *see* § 1926.6) or ISO 11660-2:1994(E) (incorporated by reference, *see* § 1926.6) except where infeasible.

(ii) Walking/stepping surfaces, except for crawler treads, must have slip-resistant features/properties (such as diamond plate metal, strategically placed grip tape, expanded metal, or slip-resistant paint).

(4) Tower cranes manufactured after November 8, 2011 must be equipped so as to provide safe access and egress between the ground and the cab, machinery platforms, and tower (mast), by the provision of devices such as steps, handholds, ladders, and guardrails/railings/grabrails. These devices must meet the following criteria:

(i) Steps, handholds, ladders, and guardrails/railings/grabrails must meet the criteria of ISO 11660-1:2008(E) (incorporated by reference, *see* § 1926.6) and ISO 11660-3:2008(E) (incorporated by reference, *see* § 1926.6) or SAE J185 (May 2003) (incorporated by reference, *see* § 1926.6) except where infeasible.

(ii) Walking/stepping surfaces must have slip-resistant features/properties (such as diamond plate metal, strategically placed grip tape, expanded metal, or slip-resistant paint).

(d) *Personal fall arrest and fall restraint systems.* Personal fall arrest system components must be used in personal fall arrest and fall restraint systems and must conform to the criteria in § 1926.502(d) except that § 1926.502(d)(15) does not apply to components used in personal fall arrest and fall restraint systems. Either body belts or body harnesses must be used in personal fall arrest and fall restraint systems.

(e) For non-assembly/disassembly work, the employer must provide and ensure the use of fall protection equipment for employees who are on a walking/working surface with an unprotected side or edge more than 6 feet above a lower level as follows:

(1) When moving point-to-point:

(i) On non-lattice booms (whether horizontal or not horizontal).

(ii) On lattice booms that are not horizontal.

(iii) On horizontal lattice booms where the fall distance is 15 feet or more.

(2) While at a work station on any part of the equipment (including the boom, of any type), except when the employee is at or near draw-works (when the equipment is running), in the cab, or on the deck.

(f) For assembly/disassembly work, the employer must provide and ensure the use of fall protection equipment for employees who are on a walking/working surface with an unprotected side or edge more than 15 feet above a lower level, except when the employee is at or near draw-works (when the equipment is running), in the cab, or on the deck.

(g) *Anchorage criteria.*

(1) Sections 1926.502(d)(15) and 1926.502(e)(2) apply to equipment covered by this subpart only to the extent delineated in paragraph (g)(2) of this section.

(2) *Anchorages for personal fall arrest and positioning device systems.*

(i) Personal fall arrest systems must be anchored to any apparently substantial part of the equipment unless a competent person, from a visual inspection, without an engineering analysis, would conclude that the criteria in § 1926.502(d)(15) would not be met.

(ii) Positioning device systems must be anchored to any apparently substantial part of the equipment unless a competent person, from a visual inspection, without an engineering analysis, would conclude that the criteria in § 1926.502(e)(2) would not be met.

(iii) Attachable anchor devices (portable anchor devices that are

attached to the equipment) must meet the anchorage criteria in § 1926.502(d)(15) for personal fall arrest systems and § 1926.502(e)(2) for positioning device systems.

(3) *Anchorages for fall restraint systems.* Fall restraint systems must be anchored to any part of the equipment that is capable of withstanding twice the maximum load that an employee may impose on it during reasonably anticipated conditions of use.

(h) *Tower cranes.*

(1) For work other than erecting, climbing, and dismantling, the employer must provide and ensure the use of fall protection equipment for employees who are on a walking/working surface with an unprotected side or edge more than 6 feet above a lower level, except when the employee is at or near draw-works (when the equipment is running), in the cab, or on the deck.

(2) For erecting, climbing, and dismantling work, the employer must provide and ensure the use of fall protection equipment for employees who are on a walking/working surface with an unprotected side or edge more than 15 feet above a lower level.

(i) *[Reserved.]*

(j) *Anchoring to the load line.* A personal fall arrest system is permitted to be anchored to the crane/derrick's hook (or other part of the load line) where all of the following requirements are met:

(1) A qualified person has determined that the set-up and rated capacity of the crane/derrick (including the hook, load line and rigging) meets or exceeds the requirements in § 1926.502(d)(15).

(2) The equipment operator must be at the work site and informed that the equipment is being used for this purpose.

(3) No load is suspended from the load line when the personal fall arrest system is anchored to the crane/derrick's hook (or other part of the load line).

(k) *Training.* The employer must train each employee who may be exposed to fall hazards while on, or hoisted by, equipment covered by this subpart on all of the following:

(1) the requirements in this subpart that address fall protection.

(2) the applicable requirements in §§ 1926.500 and 1926.502.

§ 1926.1424 Work area control.

(a) *Swing radius hazards.*

(1) The requirements in paragraph (a)(2) of this section apply where there are accessible areas in which the equipment's rotating superstructure (whether permanently or temporarily

mounted) poses a reasonably foreseeable risk of:

(i) Striking and injuring an employee; or

(ii) Pinching/crushing an employee against another part of the equipment or another object.

(2) To prevent employees from entering these hazard areas, the employer must:

(i) Train each employee assigned to work on or near the equipment ("authorized personnel") in how to recognize struck-by and pinch/crush hazard areas posed by the rotating superstructure.

(ii) Erect and maintain control lines, warning lines, railings or similar barriers to mark the boundaries of the hazard areas. *Exception:* When the employer can demonstrate that it is neither feasible to erect such barriers on the ground nor on the equipment, the hazard areas must be clearly marked by a combination of warning signs (such as "Danger—Swing/Crush Zone") and high visibility markings on the equipment that identify the hazard areas. In addition, the employer must train each employee to understand what these markings signify.

(3) *Protecting employees in the hazard area.*

(i) Before an employee goes to a location in the hazard area that is out of view of the operator, the employee (or someone instructed by the employee) must ensure that the operator is informed that he/she is going to that location.

(ii) Where the operator knows that an employee went to a location covered by paragraph (a)(1) of this section, the operator must not rotate the superstructure until the operator is informed in accordance with a pre-arranged system of communication that the employee is in a safe position.

(b) Where any part of a crane/derrick is within the working radius of another crane/derrick, the controlling entity must institute a system to coordinate operations. If there is no controlling entity, the employer (if there is only one employer operating the multiple pieces of equipment), or employers, must institute such a system.

§ 1926.1425 Keeping clear of the load.

(a) Where available, hoisting routes that minimize the exposure of employees to hoisted loads must be used, to the extent consistent with public safety.

(b) While the operator is not moving a suspended load, no employee must be within the fall zone, except for employees:

(1) Engaged in hooking, unhooking or guiding a load;

(2) Engaged in the initial attachment of the load to a component or structure; or

(3) Operating a concrete hopper or concrete bucket.

(c) When employees are engaged in hooking, unhooking, or guiding the load, or in the initial connection of a load to a component or structure and are within the fall zone, all of the following criteria must be met:

(1) The materials being hoisted must be rigged to prevent unintentional displacement.

(2) Hooks with self-closing latches or their equivalent must be used. *Exception:* "J" hooks are permitted to be used for setting wooden trusses.

(3) The materials must be rigged by a qualified rigger.

(d) *Receiving a load.* Only employees needed to receive a load are permitted to be within the fall zone when a load is being landed.

(e) During a tilt-up or tilt-down operation:

(1) No employee must be directly under the load.

(2) Only employees essential to the operation are permitted in the fall zone (but not directly under the load). An employee is essential to the operation if the employee is conducting one of the following operations and the employer can demonstrate it is infeasible for the employee to perform that operation from outside the fall zone: (1) Physically guide the load; (2) closely monitor and give instructions regarding the load's movement; or (3) either detach it from or initially attach it to another component or structure (such as, but not limited to, making an initial connection or installing bracing).

Note: Boom free fall is prohibited when an employee is in the fall zone of the boom or load, and load line free fall is prohibited when an employee is directly under the load; see § 1926.1426.

§ 1926.1426 Free fall and controlled load lowering.

(a) *Boom free fall prohibitions.*

(1) The use of equipment in which the boom is designed to free fall (live boom) is prohibited in each of the following circumstances:

(i) An employee is in the fall zone of the boom or load.

(ii) An employee is being hoisted.

(iii) The load or boom is directly over a power line, or over any part of the area extending the Table A of § 1926.1408 clearance distance to each side of the power line; or any part of the area extending the Table A clearance distance to each side of the power line

is within the radius of vertical travel of the boom or the load.

(iv) The load is over a shaft, except where there are no employees in the shaft.

(v) The load is over a cofferdam, except where there are no employees in the fall zone of the boom or the load.

(vi) Lifting operations are taking place in a refinery or tank farm.

(2) The use of equipment in which the boom is designed to free fall (live boom) is permitted only where none of the circumstances listed in paragraph (a)(1) of this section are present and:

(i) The equipment was manufactured prior to October 31, 1984; or

(ii) The equipment is a floating crane/derrick or a land crane/derrick on a vessel/flotation device.

(b) *Preventing boom free fall.* Where the use of equipment with a boom that is designed to free fall (live boom) is prohibited, the boom hoist must have a secondary mechanism or device designed to prevent the boom from falling in the event the primary system used to hold or regulate the boom hoist fails, as follows:

(1) Friction drums must have:

(i) A friction clutch and, in addition, a braking device, to allow for controlled boom lowering.

(ii) A secondary braking or locking device, which is manually or automatically engaged, to back-up the primary brake while the boom is held (such as a secondary friction brake or a ratchet and pawl device).

(2) Hydraulic drums must have an integrally mounted holding device or internal static brake to prevent boom hoist movement in the event of hydraulic failure.

(3) Neither clutches nor hydraulic motors must be considered brake or locking devices for purposes of this subpart.

(4) Hydraulic boom cylinders must have an integrally mounted holding device.

(c) *Preventing uncontrolled retraction.* Hydraulic telescoping booms must have an integrally mounted holding device to prevent the boom from retracting in the event of hydraulic failure.

(d) *Load line free fall.* In each of the following circumstances, controlled load lowering is required and free fall of the load line hoist is prohibited:

(1) An employee is directly under the load.

(2) An employee is being hoisted.

(3) The load is directly over a power line, or over any part of the area extending the Table A of § 1926.1408 clearance distance to each side of the power line; or any part of the area extending the Table A of § 1926.1408

clearance distance to each side of the power line is within the radius of vertical travel of the load.

(4) The load is over a shaft.

(5) The load is over a cofferdam, except where there are no employees in the fall zone of the load.

§ 1926.1427 Operator qualification and certification.

(a) The employer must ensure that, prior to operating any equipment covered under subpart CC, the person is operating the equipment during a training period in accordance with paragraph (f) of this section, or the operator is qualified or certified to operate the equipment in accordance with the following:

(1) When a non-military government entity issues operator licenses for equipment covered under subpart CC, and that government licensing program meets the requirements of paragraphs (e)(2) and (j) of this section, the equipment operator must either be:

(i) Licensed by that government entity for operation of equipment within that entity's jurisdiction; or

(ii) qualified in compliance with paragraph (d) of this section.

(2) Where paragraph (a)(1) of this section is not applicable, the certification or qualification must comply with one of the options in paragraphs (b) through (d) of this section.

(3) *Exceptions:* Operator qualification or certification under this section is not required for operators of derricks (see § 1926.1436), sideboom cranes (see § 1926.1440), or equipment with a maximum manufacturer-rated hoisting/lifting capacity of 2,000 pounds or less (see § 1926.1441).

(4) Whenever operator qualification or certification is required under § 1926.1427, the employer must provide the qualification or certification at no cost to operators who are employed by the employer on November 8, 2010.

(b) *Option (1): Certification by an accredited crane operator testing organization.*

(1) For a testing organization to be considered accredited to certify operators under this subpart, it must:

(i) Be accredited by a nationally recognized accrediting agency based on that agency's determination that industry recognized criteria for written testing materials, practical examinations, test administration, grading, facilities/equipment and personnel have been met.

(ii) Administer written and practical tests that:

(A) Assess the operator applicant regarding, at a minimum, the knowledge

and skills listed in paragraphs (j)(1) and (2) of this section.

(B) Provide different levels of certification based on equipment capacity and type.

(iii) Have procedures for operators to re-apply and be re-tested in the event an operator applicant fails a test or is decertified.

(iv) Have testing procedures for re-certification designed to ensure that the operator continues to meet the technical knowledge and skills requirements in paragraphs (j)(1) and (2) of this section.

(v) Have its accreditation reviewed by the nationally recognized accrediting agency at least every three years.

(2) An operator will be deemed qualified to operate a particular piece of equipment if the operator is certified under paragraph (b) of this section for that type and capacity of equipment or for higher-capacity equipment of that type. If no accredited testing agency offers certification examinations for a particular type and/or capacity of equipment, an operator will be deemed qualified to operate that equipment if the operator has been certified for the type/capacity that is most similar to that equipment and for which a certification examination is available. The operator's certificate must state the type/capacity of equipment for which the operator is certified.

(3) A certification issued under this option is portable and meets the requirements of paragraph (a)(2) of this section.

(4) A certification issued under this paragraph is valid for 5 years.

(c) *Option (2): Qualification by an audited employer program.* The employer's qualification of its employee must meet the following requirements:

(1) The written and practical tests must be either:

(i) Developed by an accredited crane operator testing organization (see paragraph (b) of this section); or

(ii) Approved by an auditor in accordance with the following requirements:

(A) The auditor is certified to evaluate such tests by an accredited crane operator testing organization (see paragraph (b) of this section).

(B) The auditor is not an employee of the employer.

(C) The approval must be based on the auditor's determination that the written and practical tests meet nationally recognized test development criteria and are valid and reliable in assessing the operator applicants regarding, at a minimum, the knowledge and skills listed in paragraphs (j)(1) and (2) of this section.

(D) The audit must be conducted in accordance with nationally recognized auditing standards.

(2) *Administration of tests.*

(i) The written and practical tests must be administered under circumstances approved by the auditor as meeting nationally recognized test administration standards.

(ii) The auditor must be certified to evaluate the administration of the written and practical tests by an accredited crane operator testing organization (see paragraph (b) of this section).

(iii) The auditor must not be an employee of the employer.

(iv) The audit must be conducted in accordance with nationally recognized auditing standards.

(3) The employer program must be audited within 3 months of the beginning of the program and at least every 3 years thereafter.

(4) The employer program must have testing procedures for re-qualification designed to ensure that the operator continues to meet the technical knowledge and skills requirements in paragraphs (j)(1) and (2) of this section. The re-qualification procedures must be audited in accordance with paragraphs (c)(1) and (2) of this section.

(5) *Deficiencies.* If the auditor determines that there is a significant deficiency ("deficiency") in the program, the employer must ensure that:

(i) No operator is qualified until the auditor confirms that the deficiency has been corrected.

(ii) The program is audited again within 180 days of the confirmation that the deficiency was corrected.

(iii) The auditor files a documented report of the deficiency to the appropriate Regional Office of the Occupational Safety and Health Administration within 15 days of the auditor's determination that there is a deficiency.

(iv) Records of the audits of the employer's program are maintained by the auditor for three years and are made available by the auditor to the Secretary of Labor or the Secretary's designated representative upon request.

(6) A qualification under this paragraph is:

(i) Not portable. Such a qualification meets the requirements of paragraph (a) of this section only where the operator is employed by (and operating the equipment for) the employer that issued the qualification.

(ii) Valid for 5 years.

(d) *Option (3): Qualification by the U.S. military.*

(1) For purposes of this section, an operator who is an employee of the U.S.

military is considered qualified if he/she has a current operator qualification issued by the U.S. military for operation of the equipment. An employee of the U.S. military is a Federal employee of the Department of Defense or Armed Forces and does not include employees of private contractors.

(2) A qualification under this paragraph is:

(i) Not portable. Such a qualification meets the requirements of paragraph (a) of this section only where the operator is employed by (and operating the equipment for) the employer that issued the qualification.

(ii) Valid for the period of time stipulated by the issuing entity.

(e) *Option (4): Licensing by a government entity.*

(1) For purposes of this section, a government licensing department/office that issues operator licenses for operating equipment covered by this standard is considered a government accredited crane operator testing organization if the criteria in paragraph (e)(2) of this section are met.

(2) *Licensing criteria.*

(i) The requirements for obtaining the license include an assessment, by written and practical tests, of the operator applicant regarding, at a minimum, the knowledge and skills listed in paragraphs (j)(1) and (2) of this section.

(ii) The testing meets industry recognized criteria for written testing materials, practical examinations, test administration, grading, facilities/equipment and personnel.

(iii) The government authority that oversees the licensing department/office, has determined that the requirements in paragraphs (e)(2)(i) and (ii) of this section have been met.

(iv) The licensing department/office has testing procedures for re-licensing designed to ensure that the operator continues to meet the technical knowledge and skills requirements in paragraphs (j)(1) and (2) of this section.

(3) A license issued by a government accredited crane operator testing organization that meets the requirements of this option:

(i) Meets the operator qualification requirements of this section for operation of equipment only within the jurisdiction of the government entity.

(ii) Is valid for the period of time stipulated by the licensing department/office, but no longer than 5 years.

(f) *Pre-qualification/certification training period.* An employee who is not qualified or certified under this section is permitted to operate equipment only as an operator-in-training and only

where the requirements of this paragraph are met.

(1) The employer must provide each operator-in-training with sufficient training prior to operating the equipment to enable the operator-in-training to operate the equipment safely under limitations established by this section (including continuous monitoring) and any additional limitations established by the employer.

(2) The tasks performed by the operator-in-training while operating the equipment must be within the operator-in-training's ability.

(3) *Trainer.* While operating the equipment, the operator-in-training must be continuously monitored by an individual ("operator's trainer") who meets all of the following requirements:

(i) The operator's trainer is an employee or agent of the operator-in-training's employer.

(ii) The operator's trainer is either a certified operator under this section, or has passed the written portion of a certification test under one of the options in paragraphs (b) through (e) of this section, and is familiar with the proper use of the equipment's controls.

(iii) While monitoring the operator-in-training, the operator's trainer performs no tasks that detract from the trainer's ability to monitor the operator-in-training.

(iv) For equipment other than tower cranes: The operator's trainer and the operator-in-training must be in direct line of sight of each other. In addition, they must communicate verbally or by hand signals. For tower cranes: The operator's trainer and the operator-in-training must be in direct communication with each other.

(4) *Continuous monitoring.* The operator-in-training must be monitored by the operator's trainer at all times, except for short breaks where all of the following are met:

(i) The break lasts no longer than 15 minutes and there is no more than one break per hour.

(ii) Immediately prior to the break the operator's trainer informs the operator-in-training of the specific tasks that the operator-in-training is to perform and limitations to which he/she must adhere during the operator trainer's break.

(iii) The specific tasks that the operator-in-training will perform during the operator trainer's break are within the operator-in-training's abilities.

(5) The operator-in-training must not operate the equipment in any of the following circumstances unless the exception stated in paragraph (f)(5)(v) of this section is applicable:

(i) If any part of the equipment, load line or load (including rigging and

lifting accessories), if operated up to the equipment's maximum working radius in the work zone (see § 1926.1408(a)(1)), could get within 20 feet of a power line that is up to 350 kV, or within 50 feet of a power line that is over 350 kV.

(ii) If the equipment is used to hoist personnel.

(iii) In multiple-equipment lifts.

(iv) If the equipment is used over a shaft, cofferdam, or in a tank farm.

(v) In multiple-lift rigging operations, except where the operator's trainer determines that the operator-in-training skills are sufficient for this high-skill work.

(g) Under this section, a testing entity is permitted to provide training as well as testing services as long as the criteria of the applicable accrediting agency (in the option selected) for an organization providing both services are met.

(h) *Language and Literacy Requirements.*

(1) Tests under this section may be administered verbally, with answers given verbally, where the operator candidate:

(i) Passes a written demonstration of literacy relevant to the work.

(ii) Demonstrates the ability to use the type of written manufacturer procedures applicable to the class/type of equipment for which the candidate is seeking certification.

(2) Tests under this section may be administered in any language the operator candidate understands, and the operator's certificate must note the language in which the test was given. The operator is qualified under paragraph (b)(2) of this section to operate equipment that is furnished with materials required by this subpart that are written in the language of the certification. The operator may only operate equipment furnished with such materials.

(i) *[Reserved.]*

(j) *Certification criteria.* Qualifications and certifications must be based, at a minimum, on the following:

(1) A determination through a written test that:

(i) The individual knows the information necessary for safe operation of the specific type of equipment the individual will operate, including all of the following:

(A) The controls and operational/performance characteristics.

(B) Use of, and the ability to calculate (manually or with a calculator), load/capacity information on a variety of configurations of the equipment.

(C) Procedures for preventing and responding to power line contact.

(D) Technical knowledge similar to the subject matter criteria listed in

Appendix C of this subpart applicable to the specific type of equipment the individual will operate. Use of the Appendix C criteria meets the requirements of this provision.

(E) Technical knowledge applicable to:

(1) The suitability of the supporting ground and surface to handle expected loads.

(2) Site hazards.

(3) Site access.

(F) This subpart, including applicable incorporated materials.

(ii) The individual is able to read and locate relevant information in the equipment manual and other materials containing information referred to in paragraph (j)(1)(i) of this section.

(2) A determination through a practical test that the individual has the skills necessary for safe operation of the equipment, including the following:

(i) Ability to recognize, from visual and auditory observation, the items listed in § 1926.1412(d) (shift inspection).

(ii) Operational and maneuvering skills.

(iii) Application of load chart information.

(iv) Application of safe shut-down and securing procedures.

(k) *Phase-in*.

(1) The provisions of this section are applicable November 8, 2010, except for paragraphs (a)(2) and (f) which are applicable November 10, 2014.

(2) When § 1926.1427(a)(1) is not applicable, all of the requirements in paragraphs (k)(2)(i) and (ii) of this section apply until November 10, 2014:

(i) The employer must ensure that operators of equipment covered by this standard are competent to operate the equipment safely.

(ii) Where an employee assigned to operate machinery does not have the required knowledge or ability to operate the equipment safely, the employer must train that employee prior to operating the equipment. The employer must ensure that each operator is evaluated to confirm that he/she understands the information provided in the training.

§ 1926.1428 Signal person qualifications.

(a) The employer of the signal person must ensure that each signal person meets the Qualification Requirements (paragraph (c) of this section) prior to giving any signals. This requirement must be met by using either Option (1) or Option (2) of this section.

(1) *Option (1)—Third party qualified evaluator.* The signal person has documentation from a third party qualified evaluator (*see* Qualified

Evaluator (third party), § 1926.1401 for definition) showing that the signal person meets the Qualification Requirements (*see* paragraph (c) of this section).

(2) *Option (2)—Employer's qualified evaluator.* The employer's qualified (*see* Qualified Evaluator (not a third party), § 1926.1401 for definition) evaluator assesses the individual and determines that the individual meets the Qualification Requirements (*see* paragraph (c) of this section) and provides documentation of that determination. An assessment by an employer's qualified evaluator under this option is not portable—other employers are not permitted to use it to meet the requirements of this section.

(3) The employer must make the documentation for whichever option is used available at the site while the signal person is employed by the employer. The documentation must specify each type of signaling (*e.g.* hand signals, radio signals, *etc.*) for which the signal person meets the requirements of paragraph (c) of this section.

(b) If subsequent actions by the signal person indicate that the individual does not meet the Qualification Requirements (*see* paragraph (c) of this section), the employer must not allow the individual to continue working as a signal person until re-training is provided and a re-assessment is made in accordance with paragraph (a) of this section that confirms that the individual meets the Qualification Requirements.

(c) *Qualification Requirements.* Each signal person must:

(1) Know and understand the type of signals used. If hand signals are used, the signal person must know and understand the Standard Method for hand signals.

(2) Be competent in the application of the type of signals used.

(3) Have a basic understanding of equipment operation and limitations, including the crane dynamics involved in swinging and stopping loads and boom deflection from hoisting loads.

(4) Know and understand the relevant requirements of § 1926.1419 through § 1926.1422 and § 1926.1428.

(5) Demonstrate that he/she meets the requirements in paragraphs (c)(1) through (4) of this section through an oral or written test, and through a practical test.

§ 1926.1429 Qualifications of maintenance & repair employees.

(a) Maintenance, inspection and repair personnel are permitted to operate the equipment only where all of the following requirements are met:

(1) The operation is limited to those functions necessary to perform maintenance, inspect the equipment, or verify its performance.

(2) The personnel either:

(i) Operate the equipment under the direct supervision of an operator who meets the requirements of § 1926.1427 (Operator qualification and certification); or

(ii) Are familiar with the operation, limitations, characteristics and hazards associated with the type of equipment.

(b) Maintenance and repair personnel must meet the definition of a qualified person with respect to the equipment and maintenance/repair tasks performed.

§ 1926.1430 Training.

The employer must provide training as follows:

(a) *Overhead powerlines.* The employer must train each employee specified in § 1926.1408(g) and § 1926.1410(m) in the topics listed in § 1926.1408(g).

(b) *Signal persons.* The employer must train each employee who will be assigned to work as a signal persons who does not meet the requirements of § 1926.1428(c) in the areas addressed in that paragraph.

(c) *Operators.*

(1) *Operators-in-Training for equipment where certification or qualification is required by this subpart.* The employer must train each operator-in-training in the areas addressed in § 1926.1427(j). The employer must provide re-training if the operator-in-training does not pass a qualification or certification test.

(2) *Transitional Period.* During the four-year phase-in period for operator certification or qualification, as provided in § 1926.1427(k), employers must train each operator who has not yet been certified or qualified in the areas addressed in § 1926.1427(j).

(3) *Operators excepted from the requirements of § 1926.1427.* The employer must train each operator excepted under § 1926.1427(a) from the requirements of § 1926.1427 on the safe operation of the equipment the operator will be using.

(4) The employer must train each operator of the equipment covered by this subpart in the following practices:

(i) On friction equipment, whenever moving a boom off a support, first raise the boom a short distance (sufficient to take the load of the boom) to determine if the boom hoist brake needs to be adjusted. On other types of equipment with a boom, the same practice is applicable, except that typically there is no means of adjusting the brake; if the

brake does not hold, a repair is necessary. See § 1926.1417(f) and (j) for additional requirements.

(ii) Where available, the manufacturer's emergency procedures for halting unintended equipment movement.

(d) *Competent persons and qualified persons.* The employer must train each competent person and each qualified person regarding the requirements of this subpart applicable to their respective roles.

(e) *Crush/pinch points.* The employer must train each employee who works with the equipment to keep clear of holes, and crush/pinch points and the hazards addressed in § 1926.1424 (Work area control).

(f) *Tag-out.* The employer must train each operator and each additional employee authorized to start/energize equipment or operate equipment controls (such as maintenance and repair employees), in the tag-out and start-up procedures in §§ 1926.1417(f) and (g).

(g) *Training administration.*

(1) The employer must evaluate each employee required to be trained under this subpart to confirm that the employee understands the information provided in the training.

(2) The employer must provide refresher training in relevant topics for each employee when, based on the conduct of the employee or an evaluation of the employee's knowledge, there is an indication that retraining is necessary.

(3) Whenever training is required under subpart CC, the employer must provide the training at no cost to the employee.

§ 1926.1431 Hoisting personnel.

The requirements of this section are supplemental to the other requirements in this subpart and apply when one or more employees are hoisted.

(a) The use of equipment to hoist employees is prohibited except where the employer demonstrates that the erection, use, and dismantling of conventional means of reaching the work area, such as a personnel hoist, ladder, stairway, aerial lift, elevating work platform, or scaffold, would be more hazardous, or is not possible because of the project's structural design or worksite conditions. This paragraph does not apply to work covered by subpart R (Steel Erection) of this part.

(b) *Use of personnel platform.*

(1) When using equipment to hoist employees, the employees must be in a personnel platform that meets the requirements of paragraph (e) of this section.

(2) *Exceptions:* A personnel platform is not required for hoisting employees:

(i) Into and out of drill shafts that are up to and including 8 feet in diameter (see paragraph (o) of this section for requirements for hoisting these employees).

(ii) In pile driving operations (see paragraph (p) of this section for requirements for hoisting these employees).

(iii) Solely for transfer to or from a marine worksite in a marine-hoisted personnel transfer device (see paragraph (r) of this section for requirements for hoisting these employees).

(iv) In storage-tank (steel or concrete), shaft and chimney operations (see paragraph (s) of this section for requirements for hoisting these employees).

(c) *Equipment set-up.*

(1) The equipment must be uniformly level, within one percent of level grade, and located on footing that a qualified person has determined to be sufficiently firm and stable.

(2) Equipment with outriggers or stabilizers must have them all extended and locked. The amount of extension must be the same for all outriggers and stabilizers and in accordance with manufacturer procedures and load charts.

(d) *Equipment criteria.*

(1) *Capacity: Use of suspended personnel platforms.* The total load (with the platform loaded, including the hook, load line and rigging) must not exceed 50 percent of the rated capacity for the radius and configuration of the equipment, except during proof testing.

(2) *Capacity: Use of boom-attached personnel platforms.* The total weight of the loaded personnel platform must not exceed 50 percent of the rated capacity for the radius and configuration of the equipment (except during proof testing).

(3) *Capacity: Hoisting personnel without a personnel platform.* When hoisting personnel without a personnel platform pursuant to paragraph (b)(2) of this section, the total load (including the hook, load line, rigging and any other equipment that imposes a load) must not exceed 50 percent of the rated capacity for the radius and configuration of the equipment, except during proof testing.

(4) When the occupied personnel platform is in a stationary working position, the load and boom hoist brakes, swing brakes, and operator actuated secondary braking and locking features (such as pawls or dogs) or automatic secondary brakes must be engaged.

(5) *Devices.*

(i) Equipment (except for derricks and articulating cranes) with a variable angle boom must be equipped with all of the following:

(A) A boom angle indicator, readily visible to the operator, and

(B) A boom hoist limiting device.

(ii) Articulating cranes must be equipped with a properly functioning automatic overload protection device.

(iii) Equipment with a luffing jib must be equipped with:

(A) A jib angle indicator, readily visible to the operator, and

(B) A jib hoist limiting device.

(iv) Equipment with telescoping booms must be equipped with a device to indicate the boom's extended length clearly to the operator, or must have measuring marks on the boom.

(v) *Anti two-block.* A device which automatically prevents damage and load failure from contact between the load block, overhaul ball, or similar component, and the boom tip (or fixed upper block or similar component) must be used. The device(s) must prevent such damage/failure at all points where two-blocking could occur. *Exception:* This device is not required when hoisting personnel in pile driving operations. Instead, paragraph (p)(2) of this section specifies how to prevent two-blocking during such operations.

(vi) *Controlled load lowering.* The load line hoist drum must have a system, other than the load line hoist brake, which regulates the lowering rate of speed of the hoist mechanism. This system or device must be used when hoisting personnel.

Note: Free fall of the load line hoist is prohibited (see § 1926.1426(d)); the use of equipment in which the boom hoist mechanism can free fall is also prohibited (see § 1926.1426(a)(1)).

(vii) *Proper operation required.*

Personnel hoisting operations must not begin unless the devices listed in this section are in proper working order. If a device stops working properly during such operations, the operator must safely stop operations. Personnel hoisting operations must not resume until the device is again working properly. Alternative measures are not permitted. (See § 1926.1417 for tag-out and related requirements.)

(6) Direct attachment of a personnel platform to a luffing jib is prohibited.

(e) *Personnel platform criteria.*

(1) A qualified person familiar with structural design must design the personnel platform and attachment/suspension system used for hoisting personnel.

(2) The system used to connect the personnel platform to the equipment

must allow the platform to remain within 10 degrees of level, regardless of boom angle.

(3) The suspension system must be designed to minimize tipping of the platform due to movement of employees occupying the platform.

(4) The personnel platform itself (excluding the guardrail system and personal fall arrest system anchorages), must be capable of supporting, without failure, its own weight and at least five times the maximum intended load.

(5) All welding of the personnel platform and its components must be performed by a certified welder familiar with the weld grades, types and material specified in the platform design.

(6) The personnel platform must be equipped with a guardrail system which meets the requirements of subpart M of this part, and must be enclosed at least from the toeboard to mid-rail with either solid construction material or expanded metal having openings no greater than ½ inch (1.27 cm). Points to which personal fall arrest systems are attached must meet the anchorage requirements in subpart M of this part.

(7) A grab rail must be installed inside the entire perimeter of the personnel platform except for access gates/doors.

(8) *Access gates/doors.* If installed, access gates/doors of all types (including swinging, sliding, folding, or other types) must:

(i) Not swing outward. If due to the size of the personnel platform, such as a 1-person platform, it is infeasible for the door to swing inward and allow safe entry for the platform occupant, then the access gate/door may swing outward.

(ii) Be equipped with a device that prevents accidental opening.

(9) Headroom must be sufficient to allow employees to stand upright in the platform.

(10) In addition to the use of hard hats, employees must be protected by overhead protection on the personnel platform when employees are exposed to falling objects. The platform overhead protection must not obscure the view of the operator or platform occupants (such as wire mesh that has up to ½ inch openings), unless full protection is necessary.

(11) All edges exposed to employee contact must be smooth enough to prevent injury.

(12) The weight of the platform and its rated capacity must be conspicuously posted on the platform with a plate or other permanent marking.

(f) *Personnel platform loading.*

(1) The personnel platform must not be loaded in excess of its rated capacity.

(2) *Use.*

(i) Personnel platforms must be used only for employees, their tools, and the materials necessary to do their work. Platforms must not be used to hoist materials or tools when not hoisting personnel.

(ii) *Exception:* Materials and tools to be used during the lift, if secured and distributed in accordance with paragraph (f)(3) of this section may be in the platform for trial lifts.

(3) Materials and tools must be:

(i) Secured to prevent displacement.

(ii) Evenly distributed within the confines of the platform while it is suspended.

(4) The number of employees occupying the personnel platform must not exceed the maximum number the platform was designed to hold or the number required to perform the work, whichever is less.

(g) *Attachment and rigging.*

(1) *Hooks and other detachable devices.*

(i) Hooks used in the connection between the hoist line and the personnel platform (including hooks on overhaul ball assemblies, lower load blocks, bridle legs, or other attachment assemblies or components) must be:

(A) Of a type that can be closed and locked, eliminating the throat opening.

(B) Closed and locked when attached.

(ii) Shackles used in place of hooks must be of the alloy anchor type, with either:

(A) A bolt, nut and retaining pin, in place; or

(B) Of the screw type, with the screw pin secured from accidental removal.

(iii) Where other detachable devices are used, they must be of the type that can be closed and locked to the same extent as the devices addressed in paragraphs (g)(1)(i) and (ii) of this section. Such devices must be closed and locked when attached.

(2) *Rope bridle.* When a rope bridle is used to suspend the personnel platform, each bridle leg must be connected to a master link or shackle (*see* paragraph (g)(1) of this section) in a manner that ensures that the load is evenly divided among the bridle legs.

(3) Rigging hardware (including wire rope, shackles, rings, master links, and other rigging hardware) and hooks must be capable of supporting, without failure, at least five times the maximum intended load applied or transmitted to that component. Where rotation resistant rope is used, the slings must be capable of supporting without failure at least ten times the maximum intended load.

(4) Eyes in wire rope slings must be fabricated with thimbles.

(5) Bridles and associated rigging for suspending the personnel platform must

be used only for the platform and the necessary employees, their tools and materials necessary to do their work. The bridles and associated rigging must not have been used for any purpose other than hoisting personnel.

(h) *Trial lift and inspection.*

(1) A trial lift with the unoccupied personnel platform loaded at least to the anticipated liftweight must be made from ground level, or any other location where employees will enter the platform, to each location at which the platform is to be hoisted and positioned. Where there is more than one location to be reached from a single set-up position, either individual trial lifts for each location, or a single trial lift, in which the platform is moved sequentially to each location, must be performed; the method selected must be the same as the method that will be used to hoist the personnel.

(2) The trial lift must be performed immediately prior to each shift in which personnel will be hoisted. In addition, the trial lift must be repeated prior to hoisting employees in each of the following circumstances:

(i) The equipment is moved and set up in a new location or returned to a previously used location.

(ii) The lift route is changed, unless the competent person determines that the new route presents no new factors affecting safety.

(3) The competent person must determine that:

(i) Safety devices and operational aids required by this section are activated and functioning properly. Other safety devices and operational aids must meet the requirements of § 1926.1415 and § 1926.1416.

(ii) Nothing interferes with the equipment or the personnel platform in the course of the trial lift.

(iii) The lift will not exceed 50 percent of the equipment's rated capacity at any time during the lift.

(iv) The load radius to be used during the lift has been accurately determined.

(4) Immediately after the trial lift, the competent person must:

(i) Conduct a visual inspection of the equipment, base support or ground, and personnel platform, to determine whether the trial lift has exposed any defect or problem or produced any adverse effect.

(ii) Confirm that, upon the completion of the trial lift process, the test weight has been removed.

(5) Immediately prior to each lift:

(i) The platform must be hoisted a few inches with the personnel and materials/tools on board and inspected by a competent person to ensure that it is secure and properly balanced.

(ii) The following conditions must be determined by a competent person to exist before the lift of personnel proceeds:

(A) Hoist ropes must be free of deficiencies in accordance with § 1926.1413(a).

(B) Multiple part lines must not be twisted around each other.

(C) The primary attachment must be centered over the platform.

(D) If the load rope is slack, the hoisting system must be inspected to ensure that all ropes are properly seated on drums and in sheaves.

(6) Any condition found during the trial lift and subsequent inspection(s) that fails to meet a requirement of this standard or otherwise creates a safety hazard must be corrected before hoisting personnel. (See § 1926.1417 for tag-out and related requirements.)

(i) [Reserved.]

(j) *Proof testing.*

(1) At each jobsite, prior to hoisting employees on the personnel platform, and after any repair or modification, the platform and rigging must be proof tested to 125 percent of the platform's rated capacity. The proof test may be done concurrently with the trial lift.

(2) The platform must be lowered by controlled load lowering, braked, and held in a suspended position for a minimum of five minutes with the test load evenly distributed on the platform.

(3) After proof testing, a competent person must inspect the platform and rigging to determine if the test has been passed. If any deficiencies are found that pose a safety hazard, the platform and rigging must not be used to hoist personnel unless the deficiencies are corrected, the test is repeated, and a competent person determines that the test has been passed. (See § 1926.1417 for tag-out and related requirements.)

(4) Personnel hoisting must not be conducted until the competent person determines that the platform and rigging have successfully passed the proof test.

(k) *Work practices.*

(1) Hoisting of the personnel platform must be performed in a slow, controlled, cautious manner, with no sudden movements of the equipment or the platform.

(2) Platform occupants must:

(i) Keep all parts of the body inside the platform during raising, lowering, and horizontal movement. This provision does not apply to an occupant of the platform when necessary to position the platform or while performing the duties of a signal person.

(ii) Not stand, sit on, or work from the top or intermediate rail or toeboard, or use any other means/device to raise their working height.

(iii) Not pull the platform out of plumb in relation to the hoisting equipment.

(3) Before employees exit or enter a hoisted personnel platform that is not landed, the platform must be secured to the structure where the work is to be performed, unless the employer can demonstrate that securing to the structure would create a greater hazard.

(4) If the platform is tied to the structure, the operator must not move the platform until the operator receives confirmation that it is freely suspended.

(5) Tag lines must be used when necessary to control the platform.

(6) *Platforms without controls.* Where the platform is not equipped with controls, the equipment operator must remain at the equipment controls, on site, and in view of the equipment, at all times while the platform is occupied.

(7) *Platforms with controls.* Where the platform is equipped with controls, all of the following must be met at all times while the platform is occupied:

(i) The occupant using the controls in the platform must be a qualified person with respect to their use, including the safe limitations of the equipment and hazards associated with its operation.

(ii) The equipment operator must be at a set of equipment controls that include boom and swing functions of the equipment, and must be on site and in view of the equipment.

(iii) The platform operating manual must be in the platform or on the equipment.

(8) *Environmental conditions.*

(i) *Wind.* When wind speed (sustained or gusts) exceeds 20 mph at the personnel platform, a qualified person must determine if, in light of the wind conditions, it is not safe to lift personnel. If it is not, the lifting operation must not begin (or, if already in progress, must be terminated).

(ii) *Other weather and environmental conditions.* A qualified person must determine if, in light of indications of dangerous weather conditions, or other impending or existing danger, it is not safe to lift personnel. If it is not, the lifting operation must not begin (or, if already in progress, must be terminated).

(9) Employees being hoisted must remain in direct communication with the signal person (where used), or the operator.

(10) *Fall protection.*

(i) Except over water, employees occupying the personnel platform must be provided and use a personal fall arrest system. The system must be attached to a structural member within the personnel platform. When working

over or near water, the requirements of § 1926.106 apply.

(ii) The fall arrest system, including the attachment point (anchorage) used to comply with paragraph (i) of this section, must meet the requirements in § 1926.502.

(11) *Other load lines.*

(i) No lifts must be made on any other of the equipment's load lines while personnel are being hoisted, except in pile driving operations.

(ii) *Factory-produced boom-mounted personnel platforms that incorporate a winch as original equipment.* Loads are permitted to be hoisted by such a winch while employees occupy the personnel platform only where the load on the winch line does not exceed 500 pounds and does not exceed the rated capacity of the winch and platform.

(12) *Traveling—equipment other than derricks.*

(i) Hoisting of employees while the equipment is traveling is prohibited, except for:

(A) Equipment that travels on fixed rails; or

(B) Where the employer demonstrates that there is no less hazardous way to perform the work.

(C) This exception does not apply to rubber-tired equipment.

(ii) Where employees are hoisted while the equipment is traveling, all of the following criteria must be met:

(A) Equipment travel must be restricted to a fixed track or runway.

(B) Where a runway is used, it must be a firm, level surface designed, prepared and designated as a path of travel for the weight and configuration of the equipment being used to lift and travel with the personnel platform. An existing surface may be used as long as it meets these criteria.

(C) Equipment travel must be limited to boom length.

(D) The boom must be parallel to the direction of travel, except where it is safer to do otherwise.

(E) A complete trial run must be performed to test the route of travel before employees are allowed to occupy the platform. This trial run can be performed at the same time as the trial lift required by paragraph (h) of this section which tests the lift route.

(13) *Traveling—derricks.* Derricks are prohibited from traveling while personnel are hoisted.

(l) [Reserved.]

(m) *Pre-lift meeting.* A pre-lift meeting must be:

(1) Held to review the applicable requirements of this section and the procedures that will be followed.

(2) Attended by the equipment operator, signal person (if used for the

lift), employees to be hoisted, and the person responsible for the task to be performed.

(3) Held prior to the trial lift at each new work location, and must be repeated for any employees newly assigned to the operation.

(n) *Hoisting personnel near power lines.* Hoisting personnel within 20 feet of a power line that is up to 350 kV, and hoisting personnel within 50 feet of a power line that is over 350 kV, is prohibited, except for work covered by subpart V of this part (Power Transmission and Distribution).

(o) *Hoisting personnel in drill shafts.* When hoisting employees into and out of drill shafts that are up to and including 8 feet in diameter, all of the following requirements must be met:

(1) The employee must be in either a personnel platform or on a boatswain's chair.

(2) If using a personnel platform, paragraphs (a) through (n) of this section apply.

(3) If using a boatswain's chair:

(i) The following paragraphs of this section apply: (a), (c), (d)(1), (d)(3), (d)(4), (e)(1), (e)(2), (e)(3), (f)(1), (f)(2)(i), (f)(3)(i), (g), (h), (j), (k)(1), (k)(6), (k)(8), (k)(9), (k)(11)(i), (m), (n). Where the terms "personnel platform" or "platform" are used in these paragraphs, substitute them with "boatswain's chair."

(ii) A signal person must be stationed at the shaft opening.

(iii) The employee must be hoisted in a slow, controlled descent and ascent.

(iv) The employee must use personal fall protection equipment, including a full body harness, attached independent of the crane/derrick.

(v) The fall protection equipment must meet the applicable requirements in § 1926.502.

(vi) The boatswain's chair itself (excluding the personal fall arrest system anchorages), must be capable of supporting, without failure, its own weight and at least five times the maximum intended load.

(vii) No more than one person must be hoisted at a time.

(p) *Hoisting personnel for pile driving operations.* When hoisting an employee in pile driving operations, the following requirements must be met:

(1) The employee must be in a personnel platform or boatswain's chair.

(2) For lattice boom cranes: Clearly mark the cable (so that it can easily be seen by the operator) at a point that will give the operator sufficient time to stop the hoist to prevent two-blocking, or use a spotter who is in direct communication with the operator to inform the operator when this point is reached. For telescopic boom cranes:

Clearly mark the cable (so that it can be easily seen by the operator) at a point that will give the operator sufficient time to stop the hoist to prevent two-blocking, and use a spotter who is in direct communication with the operator to inform the operator when this point is reached.

(3) If using a personnel platform, paragraphs (b) through (n) of this section apply.

(4) If using a boatswain's chair:

(i) The following paragraphs of this section apply: (a), (c), (d)(1), (d)(3), (d)(4), (e)(1), (e)(2), (e)(3), (f)(1), (f)(2)(i), (f)(3)(i), (g), (h), (j), (k)(1), (k)(6), (k)(8), (k)(9), (k)(11)(i), (m), and (n). Where the terms "personnel platform" or "platform" are used in these paragraphs, substitute them with "boatswain's chair."

(ii) The employee must be hoisted in a slow, controlled descent and ascent.

(iii) The employee must use personal fall protection equipment, including a full body harness, independently attached to the lower load block or overhaul ball.

(iv) The fall protection equipment must meet the applicable requirements in § 1926.502.

(v) The boatswain's chair itself (excluding the personal fall arrest system anchorages), must be capable of supporting, without failure, its own weight and at least five times the maximum intended load.

(vi) No more than one person must be hoisted at a time.

(q) [Reserved.]

(r) *Hoisting personnel for marine transfer.* When hoisting employees solely for transfer to or from a marine worksite, the following requirements must be met:

(1) The employee must be in either a personnel platform or a marine-hoisted personnel transfer device.

(2) If using a personnel platform, paragraphs (a) through (n) of this section apply.

(3) If using a marine-hoisted personnel transfer device:

(i) The following paragraphs of this section apply: (a), (c)(2), (d)(1), (d)(3), (d)(4), (e)(1) through (5), (e)(12), (f)(1), (g), (h), (j), (k)(1), (k)(8), (k)(9), (k)(10)(ii), (k)(11)(i), (k)(12), (m), and (n). Where the terms "personnel platform" or "platform" are used in these paragraphs, substitute them with "marine-hoisted personnel transfer device."

(ii) The transfer device must be used only for transferring workers.

(iii) The number of workers occupying the transfer device must not exceed the maximum number it was designed to hold.

(iv) Each employee must wear a U.S. Coast Guard personal flotation device approved for industrial use.

(s) *Hoisting personnel for storage-tank (steel or concrete), shaft and chimney operations.* When hoisting an employee in storage tank (steel or concrete), shaft and chimney operations, the following requirements must be met:

(1) The employee must be in a personnel platform except when the employer can demonstrate that use of a personnel platform is infeasible; in such a case, a boatswain's chair must be used.

(2) If using a personnel platform, paragraphs (a) through (n) of this section apply.

(3) If using a boatswain's chair:

(i) The following paragraphs of this section apply: (a), (c), (d)(1), (d)(3), (d)(4), (e)(1), (e)(2), (e)(3), (f)(1), (f)(2)(i), (f)(3)(i), (g), (h), (j), (k)(1), (k)(6), (k)(8), (k)(9), (k)(11)(i), (m), (n). Where the terms "personnel platform" or "platform" are used in these paragraphs, substitute them with "boatswain's chair."

(ii) The employee must be hoisted in a slow, controlled descent and ascent.

(iii) The employee must use personal fall protection equipment, including a full body harness, attached independent of the crane/derrick. When there is no adequate structure for attachment of personal fall arrest equipment as required in § 1926.502(d)(15), the attachment must be to the lower load block or overhaul ball.

(iv) The fall protection equipment must meet the applicable requirements in § 1926.502.

(v) The boatswain's chair itself (excluding the personal fall arrest system anchorages), must be capable of supporting, without failure, its own weight and at least five times the maximum intended load.

(vi) No more than one person must be hoisted at a time.

§ 1926.1432 Multiple-crane/derrick lifts—supplemental requirements.

(a) *Plan development.* Before beginning a crane/derrick operation in which more than one crane/derrick will be supporting the load, the operation must be planned. The planning must meet the following requirements:

(1) The plan must be developed by a qualified person.

(2) The plan must be designed to ensure that the requirements of this subpart are met.

(3) Where the qualified person determines that engineering expertise is needed for the planning, the employer must ensure that it is provided.

(b) *Plan implementation.*

(1) The multiple-crane/derrick lift must be directed by a person who meets the criteria for both a competent person and a qualified person, or by a competent person who is assisted by

one or more qualified persons (lift director).

(2) The lift director must review the plan in a meeting with all workers who will be involved with the operation.

§ 1926.1433 Design, construction and testing.

The following requirements apply to equipment that has a manufacturer-rated hoisting/lifting capacity of more than 2,000 pounds.

(a) Crawler, truck and locomotive cranes manufactured prior to November 8, 2010 must meet the applicable requirements for design, construction, and testing as prescribed in ANSI B30.5-1968 (incorporated by reference, *see* § 1926.6), PCSA Std. No. 2 (1968) (incorporated by reference, *see* § 1926.6), the requirements in paragraph (b) of this section, or the applicable DIN standards that were in effect at the time of manufacture.

(b) Mobile (including crawler and truck) and locomotive cranes manufactured on or after November 8, 2010 must meet the following portions of ASME B30.5-2004 (incorporated by reference, *see* § 1926.6) as applicable:

(1) In section 5-1.1.1 ("Load Ratings—Where Stability Governs Lifting Performance"), paragraphs (a)—(d) (including subparagraphs).

(2) In section 5-1.1.2 ("Load Ratings—Where Structural Competence Governs Lifting Performance"), paragraph (b).

(3) Section 5-1.2 ("Stability (Backward and Forward)").

(4) In section 5-1.3.1 ("Boom Hoist Mechanism"), paragraphs (a), (b)(1) and (b)(2), except that when using rotation resistant rope, § 1926.1414(c)(4)(ii)(A) applies.

(5) In section 5-1.3.2 ("Load Hoist Mechanism"), paragraphs (a)(2) through (a)(4) (including subparagraphs), (b) (including subparagraphs), (c) (first sentence only) and (d).

(6) Section 5-1.3.3 ("Telescoping Boom").

(7) Section 5-1.4 ("Swing Mechanism").

(8) In section 5-1.5 ("Crane Travel"), all provisions except 5-1.5.3(d).

(9) In section 5-1.6 ("Controls"), all provisions except 5-1.6.1 (c).

(10) Section 5-1.7.4 ("Sheaves").

(11) Section 5-1.7.5 ("Sheave sizes").

(12) In section 5-1.9.1 ("Booms"), paragraph (f).

(13) Section 5-1.9.3 ("Outriggers").

(14) Section 5-1.9.4 ("Locomotive Crane Equipment").

(15) Section 5-1.9.7 ("Clutch and Brake Protection").

(16) In section 5-1.9.11 ("Miscellaneous equipment"), paragraphs (a), (c), (e), and (f).

(c) Prototype testing: mobile (including crawler and truck) and locomotive cranes manufactured on or after November 8, 2010 must meet the prototype testing requirements in Test Option A or Test Option B of this section. Tower cranes manufactured on or after November 8, 2010 must meet the prototype testing requirements in BS EN 14439:2006 (incorporated by reference, *see* § 1926.6).

Note: Prototype testing of crawler, locomotive and truck cranes manufactured prior to November 8, 2010 must conform to paragraph (a) of this section.

(1) *Test Option A.*

(i) The following applies to equipment with cantilevered booms (such as hydraulic boom cranes): All the tests listed in SAE J1063 (Nov. 1993) Table 1 (incorporated by reference, *see* § 1926.6) must be performed to load all critical structural elements to their respective limits. All the strength margins listed in SAE J1063 (Nov. 1993) Table 2 (incorporated by reference, *see* § 1926.6) must be met.

(ii) The following applies to equipment with pendant supported lattice booms: All the tests listed in SAE J987 (Jun. 2003) Table 1 (incorporated by reference, *see* § 1926.6) must be performed to load all critical structural elements to their respective limits. All the strength margins listed in SAE J987 (Jun. 2003) Table 2 (incorporated by reference, *see* § 1926.6) must be met.

(2) *Test Option B.* The testing and verification requirements of BS EN 13000:2004 (incorporated by reference, *see* § 1926.6) must be met. In applying BS EN 13000:2004, the following additional requirements must be met:

(i) The following applies to equipment with cantilevered booms (such as hydraulic boom cranes): The analysis methodology (computer modeling) must demonstrate that all load cases listed in SAE J1063 (Nov. 1993) (incorporated by reference, *see* § 1926.6) meet the strength margins listed in SAE J1063 (Nov. 1993) Table 2.

(ii) The following applies to equipment with pendant supported lattice booms: The analysis methodology (computer modeling) must demonstrate that all load cases listed in SAE J987 (Jun. 2003) (incorporated by reference, *see* § 1926.6) meet the strength margins listed in SAE J987 (Jun. 2003) Table 2.

(iii) *Analysis verification.* The physical testing requirements under SAE J1063 (Nov. 1993) (incorporated by reference, *see* § 1926.6) and SAE J987 (Jun. 2003) (incorporated by reference, *see* § 1926.6) must be met unless the reliability of the analysis methodology

(computer modeling) has been demonstrated by a documented history of verification through strain gauge measuring or strain gauge measuring in combination with other physical testing.

(d) All equipment covered by this subpart must meet the following requirements:

(1) *Rated capacity and related information.* The information available in the cab (*see* § 1926.1417(c)) regarding "rated capacity" and related information must include, at a minimum, the following information:

(i) A complete range of the manufacturer's equipment rated capacities, as follows:

(A) At all manufacturer approved operating radii, boom angles, work areas, boom lengths and configurations, jib lengths and angles (or offset).

(B) Alternate ratings for use and nonuse of option equipment which affects rated capacities, such as outriggers, stabilizers, and extra counterweights.

(ii) A work area chart for which capacities are listed in the load chart. (**Note:** An example of this type of chart is in ASME B30.5-2004, section 5-1.1.3, Figure 11).

(iii) The work area figure and load chart must clearly indicate the areas where no load is to be handled.

(iv) Recommended reeving for the hoist lines must be shown.

(v) Recommended parts of hoist reeving, size, and type of wire rope for various equipment loads.

(vi) Recommended boom hoist reeving diagram, where applicable; size, type and length of wire rope.

(vii) Tire pressure (where applicable).

(viii) Caution or warnings relative to limitations on equipment and operating procedures, including an indication of the least stable direction.

(ix) Position of the gantry and requirements for intermediate boom suspension (where applicable).

(x) Instructions for boom erection and conditions under which the boom, or boom and jib combinations, may be raised or lowered.

(xi) Whether the hoist holding mechanism is automatically or manually controlled, whether free fall is available, or any combination of these.

(xii) The maximum telescopic travel length of each boom telescopic section.

(xiii) Whether sections are telescoped manually or with power.

(xiv) The sequence and procedure for extending and retracting the telescopic boom section.

(xv) Maximum loads permitted during the boom extending operation, and any limiting conditions or cautions.

(xvi) Hydraulic relief valve settings specified by the manufacturer.

(2) Load hooks (including latched and unlatched types), ball assemblies and load blocks must be of sufficient weight to overhaul the line from the highest hook position for boom or boom and jib lengths and the number of parts of the line in use.

(3) Hook and ball assemblies and load blocks must be marked with their rated capacity and weight.

(4) *Latching hooks.*

(i) Hooks must be equipped with latches, except where the requirements of paragraph (d)(4)(ii) of this section are met.

(ii) Hooks without latches, or with latches removed or disabled, must not be used unless:

(A) A qualified person has determined that it is safer to hoist and place the load without latches (or with the latches removed/tied-back).

(B) Routes for the loads are pre-planned to ensure that no employee is required to work in the fall zone except for employees necessary for the hooking or unhooking of the load.

(iii) The latch must close the throat opening and be designed to retain slings or other lifting devices/accessories in the hook when the rigging apparatus is slack.

(5) *Posted warnings.* Posted warnings required by this subpart as well as those originally supplied with the equipment by the manufacturer must be maintained in legible condition.

(6) An accessible fire extinguisher must be on the equipment.

(7) *Cabs.* Equipment with cabs must meet the following requirements:

(i) Cabs must be designed with a form of adjustable ventilation and method for clearing the windshield for maintaining visibility and air circulation. Examples of means for adjustable ventilation include air conditioner or window that can be opened (for ventilation and air circulation); examples of means for maintaining visibility include heater (for preventing windshield icing), defroster, fan, windshield wiper.

(ii) Cab doors (swinging, sliding) must be designed to prevent inadvertent opening or closing while traveling or operating the machine. Swinging doors adjacent to the operator must open outward. Sliding operator doors must open rearward.

(iii) *Windows.*

(A) The cab must have windows in front and on both sides of the operator. Forward vertical visibility must be sufficient to give the operator a view of the boom point at all times.

(B) Windows may have sections designed to be opened or readily removed. Windows with sections designed to be opened must be designed

so that they can be secured to prevent inadvertent closure.

(C) Windows must be of safety glass or material with similar optical and safety properties, that introduce no visible distortion or otherwise obscure visibility that interferes with the safe operation of the equipment.

(iv) A clear passageway must be provided from the operator's station to an exit door on the operator's side.

(v) Areas of the cab roof that serve as a workstation for rigging, maintenance or other equipment-related tasks must be capable of supporting 250 pounds without permanent distortion.

(8) Belts, gears, shafts, pulleys, sprockets, spindles, drums, fly wheels, chains, and other parts or components that reciprocate, rotate or otherwise move must be guarded where contact by employees (except for maintenance and repair employees) is possible in the performance of normal duties.

(9) All exhaust pipes, turbochargers, and charge air coolers must be insulated or guarded where contact by employees (except for maintenance and repair employees) is possible in the performance of normal duties.

(10) Hydraulic and pneumatic lines must be protected from damage to the extent feasible.

(11) The equipment must be designed so that exhaust fumes are not discharged in the cab and are discharged in a direction away from the operator.

(12) *Friction mechanisms.* Where friction mechanisms (such as brakes and clutches) are used to control the boom hoist or load line hoist, they must be:

(i) Of a size and thermal capacity sufficient to control all rated loads with the minimum recommended reeving.

(ii) Adjustable to permit compensation for lining wear to maintain proper operation.

(13) *Hydraulic load hoists.* Hydraulic drums must have an integrally mounted holding device or internal static brake to prevent load hoist movement in the event of hydraulic failure.

(e) The employer's obligations under paragraphs (a) through (c) and (d)(7) through (13) of this section are met where the equipment has not changed (except in accordance with § 1926.1434 (Equipment modifications)) and it can refer to documentation from the manufacturer showing that the equipment has been designed, constructed and tested in accordance with those paragraphs.

§ 1926.1434 Equipment modifications.

(a) Modifications or additions which affect the capacity or safe operation of the equipment are prohibited except where the requirements of paragraphs

(a)(1), (a)(2), (a)(3), (a)(4), or (a)(5) of this section are met.

(1) *Manufacturer review and approval.*

(i) The manufacturer approves the modifications/additions in writing.

(ii) The load charts, procedures, instruction manuals and instruction plates/tags/decals are modified as necessary to accord with the modification/addition.

(iii) The original safety factor of the equipment is not reduced.

(2) *Manufacturer refusal to review request.* The manufacturer is provided a detailed description of the proposed modification/addition, is asked to approve the modification/addition, but it declines to review the technical merits of the proposal or fails, within 30 days, to acknowledge the request or initiate the review, and all of the following are met:

(i) A registered professional engineer who is a qualified person with respect to the equipment involved:

(A) Approves the modification/addition and specifies the equipment configurations to which that approval applies, and

(B) Modifies load charts, procedures, instruction manuals and instruction plates/tags/decals as necessary to accord with the modification/addition.

(ii) The original safety factor of the equipment is not reduced.

(3) *Unavailable manufacturer.* The manufacturer is unavailable and the requirements of paragraphs (a)(2)(i) and (ii) of this section are met.

(4) *Manufacturer does not complete the review within 120 days of the request.* The manufacturer is provided a detailed description of the proposed modification/addition, is asked to approve the modification/addition, agrees to review the technical merits of the proposal, but fails to complete the review of the proposal within 120 days of the date it was provided the detailed description of the proposed modification/addition, and the requirements of paragraphs (a)(2)(i) and (ii) of this section are met.

(5) *Multiple manufacturers of equipment designed for use on marine work sites.* The equipment is designed for marine work sites, contains major structural components from more than one manufacturer, and the requirements of paragraphs (a)(2)(i) and (ii) of this section are met.

(b) Modifications or additions which affect the capacity or safe operation of the equipment are prohibited where the manufacturer, after a review of the technical safety merits of the proposed modification/addition, rejects the proposal and explains the reasons for

the rejection in a written response. If the manufacturer rejects the proposal but does not explain the reasons for the rejection in writing, the employer may treat this as a manufacturer refusal to review the request under paragraph (a)(2) of this section.

(c) The provisions in paragraphs (a) and (b) of this section do not apply to modifications made or approved by the U.S. military.

§ 1926.1435 Tower cranes.

(a) This section contains supplemental requirements for tower cranes; all sections of this subpart apply to tower cranes unless specified otherwise.

(b) *Erecting, climbing and dismantling.*

(1) Section 1926.1403 (Assembly/Disassembly—selection of manufacturer or employer procedures), § 1926.1404 (Assembly/Disassembly—general requirements (applies to all assembly and disassembly operations)), § 1926.1405 (Disassembly—additional requirements for dismantling of booms and jibs (applies to both the use of manufacturer procedures and employer procedures)), and § 1926.1406 (Assembly/Disassembly—employer procedures—general requirements), apply to tower cranes (except as otherwise specified), except that the term “assembly/disassembly” is replaced by “erecting, climbing and dismantling,” and the term “disassembly” is replaced by “dismantling.”

(2) *Dangerous areas (self-erecting tower cranes).* In addition to the requirements in § 1926.1404(e), for self-erecting tower cranes, the following applies: Employees must not be in or under the tower, jib, or rotating portion of the crane during erecting, climbing and dismantling operations until the crane is secured in a locked position and the competent person in charge indicates it is safe to enter this area, unless the manufacturer’s instructions direct otherwise and only the necessary personnel are permitted in this area.

(3) *Foundations and structural supports.* Tower crane foundations and structural supports (including both the portions of the structure used for support and the means of attachment) must be designed by the manufacturer or a registered professional engineer.

(4) *Addressing specific hazards.* The requirements in § 1926.1404(h)(1) through (9) apply. In addition, the A/D director must address the following:

(i) *Foundations and structural supports.* The A/D director must determine that tower crane foundations

and structural supports are installed in accordance with their design.

(ii) *Loss of backward stability.* Backward stability before swinging self erecting cranes or cranes on traveling or static undercarriages.

(iii) *Wind speed.* Wind must not exceed the speed recommended by the manufacturer or, where manufacturer does not specify this information, the speed determined by a qualified person.

(5) *Plumb tolerance.* Towers must be erected plumb to the manufacturer’s tolerance and verified by a qualified person. Where the manufacturer does not specify plumb tolerance, the crane tower must be plumb to a tolerance of at least 1:500 (approximately 1 inch in 40 feet).

(6) *Multiple tower crane jobsites.* On jobsites where more than one fixed jib (hammerhead) tower crane is installed, the cranes must be located such that no crane can come in contact with the structure of another crane. Cranes are permitted to pass over one another.

(7) *Climbing procedures.* Prior to, and during, all climbing procedures (including inside climbing and top climbing), the employer must:

(i) Comply with all manufacturer prohibitions.

(ii) Have a registered professional engineer verify that the host structure is strong enough to sustain the forces imposed through the braces, brace anchorages and supporting floors.

(8) *Counterweight/ballast.*

(i) Equipment must not be erected, dismantled or operated without the amount and position of counterweight and/or ballast in place as specified by the manufacturer or a registered professional engineer familiar with the equipment.

(ii) The maximum counterweight and/or ballast specified by the manufacturer or registered professional engineer familiar with the equipment must not be exceeded.

(c) *Signs.* The size and location of signs installed on tower cranes must be in accordance with manufacturer specifications. Where these are unavailable, a registered professional engineer familiar with the type of equipment involved must approve in writing the size and location of any signs.

(d) *Safety devices.*

(1) Section 1926.1415 does not apply to tower cranes.

(2) The following safety devices are required on all tower cranes unless otherwise specified:

(i) Boom stops on luffing boom type tower cranes.

(ii) Jib stops on luffing boom type tower cranes if equipped with a jib attachment.

(iii) Travel rail end stops at both ends of travel rail.

(iv) Travel rail clamps on all travel bogies.

(v) Integrally mounted check valves on all load supporting hydraulic cylinders.

(vi) Hydraulic system pressure limiting device.

(vii) The following brakes, which must automatically set in the event of pressure loss or power failure, are required:

(A) A hoist brake on all hoists.

(B) Swing brake.

(C) Trolley brake.

(D) Rail travel brake.

(viii) Deadman control or forced neutral return control (hand) levers.

(ix) Emergency stop switch at the operator’s station.

(x) Trolley end stops must be provided at both ends of travel of the trolley.

(3) *Proper operation required.*

Operations must not begin unless the devices listed in this section are in proper working order. If a device stops working properly during operations, the operator must safely stop operations. The equipment must be taken out of service, and operations must not resume until the device is again working properly. See § 1926.1417(f). Alternative measures are not permitted to be used.

(e) *Operational aids.*

(1) Section 1926.1416 does not apply to tower cranes.

(2) The devices listed in this section (“operational aids”) are required on all tower cranes covered by this subpart, unless otherwise specified.

(3) Operations must not begin unless the operational aids are in proper working order, except where the employer meets the specified temporary alternative measures. More protective alternative measures specified by the tower crane manufacturer, if any, must be followed. See § 1926.1417(j) for additional requirements.

(4) If an operational aid stops working properly during operations, the operator must safely stop operations until the temporary alternative measures are implemented or the device is again working properly. If a replacement part is no longer available, the use of a substitute device that performs the same type of function is permitted and is not considered a modification under § 1926.1434.

(5) *Category I operational aids and alternative measures.* Operational aids listed in this paragraph that are not working properly must be repaired no later than 7 calendar days after the deficiency occurs. *Exception:* If the employer documents that it has ordered

the necessary parts within 7 calendar days of the occurrence of the deficiency, the repair must be completed within 7 calendar days of receipt of the parts.

(i) *Trolley travel limiting device.* The travel of the trolley must be restricted at both ends of the jib by a trolley travel limiting device to prevent the trolley from running into the trolley end stops.

Temporary alternative measures:

(A) *Option A.* The trolley rope must be marked (so it can be seen by the operator) at a point that will give the operator sufficient time to stop the trolley prior to the end stops.

(B) *Option B.* A spotter who is in direct communication with the operator must be used when operations are conducted within 10 feet of the outer or inner trolley end stops.

(ii) *Boom hoist limiting device.* The range of the boom must be limited at the minimum and maximum radius.

Temporary alternative measures:

Clearly mark the cable (so it can be seen by the operator) at a point that will give the operator sufficient time to stop the boom hoist within the minimum and maximum boom radius, or use a spotter who is in direct communication with the operator to inform the operator when this point is reached.

(iii) *Anti two-blocking device.* The tower crane must be equipped with a device which automatically prevents damage from contact between the load block, overhaul ball, or similar component, and the boom tip (or fixed upper block or similar component). The device(s) must prevent such damage at all points where two-blocking could occur. *Temporary alternative measures:* Clearly mark the cable (so it can be seen by the operator) at a point that will give the operator sufficient time to stop the hoist to prevent two-blocking, or use a spotter who is in direct communication with the operator to inform the operator when this point is reached.

(iv) *Hoist drum lower limiting device.* Tower cranes manufactured after November 8, 2011 must be equipped with a device that prevents the last 2 wraps of hoist cable from being spooled off the drum. *Temporary alternative measures:* Mark the cable (so it can be seen by the operator) at a point that will give the operator sufficient time to stop the hoist prior to last 2 wraps of hoist cable being spooled off the drum, or use a spotter who is in direct communication with the operator to inform the operator when this point is reached.

(v) *Load moment limiting device.* The tower crane must have a device that prevents moment overloading.

Temporary alternative measures: A radius indicating device must be used

(if the tower crane is not equipped with a radius indicating device, the radius must be measured to ensure the load is within the rated capacity of the crane). In addition, the weight of the load must be determined from a source recognized by the industry (such as the load's manufacturer), or by a calculation method recognized by the industry (such as calculating a steel beam from measured dimensions and a known per foot weight), or by other equally reliable means. This information must be provided to the operator prior to the lift.

(vi) *Hoist line pull limiting device.*

The capacity of the hoist must be limited to prevent overloading, including each individual gear ratio if equipped with a multiple speed hoist transmission. *Temporary alternative measures:* The operator must ensure that the weight of the load does not exceed the capacity of the hoist (including for each individual gear ratio if equipped with a multiple speed hoist transmission).

(vii) *Rail travel limiting device.* The travel distance in each direction must be limited to prevent the travel bogies from running into the end stops or buffers.

Temporary alternative measures: A spotter who is in direct communication with the operator must be used when operations are conducted within 10 feet of either end of the travel rail end stops; the spotter must inform the operator of the distance of the travel bogies from the end stops or buffers.

(viii) *Boom hoist drum positive locking device and control.* The boom hoist drum must be equipped with a control that will enable the operator to positively lock the boom hoist drum from the cab. *Temporary alternative measures:* The device must be manually set when required if an electric, hydraulic or automatic control is not functioning.

(6) *Category II operational aids and alternative measures.* Operational aids listed in this paragraph that are not working properly must be repaired no later than 30 calendar days after the deficiency occurs. *Exception:* If the employer documents that it has ordered the necessary parts within 7 calendar days of the occurrence of the deficiency, and the part is not received in time to complete the repair in 30 calendar days, the repair must be completed within 7 calendar days of receipt of the parts.

(i) *Boom angle or hook radius indicator.*

(A) Luffing boom tower cranes must have a boom angle indicator readable from the operator's station.

(B) Hammerhead tower cranes manufactured after November 8, 2011

must have a hook radius indicator readable from the operator's station.

(C) *Temporary alternative measures:* Hook radii or boom angle must be determined by measuring the hook radii or boom angle with a measuring device.

(ii) *Trolley travel deceleration device.* The trolley speed must be automatically reduced prior to the trolley reaching the end limit in both directions. *Temporary alternative measure:* The employer must post a notice in the cab of the crane notifying the operator that the trolley travel deceleration device is malfunctioning and instructing the operator to take special care to reduce the trolley speed when approaching the trolley end limits.

(iii) *Boom hoist deceleration device.* The boom speed must be automatically reduced prior to the boom reaching the minimum or maximum radius limit.

Temporary alternative measure: The employer must post a notice in the cab of the crane notifying the operator that the boom hoist deceleration device is malfunctioning and instructing the operator to take special care to reduce the boom speed when approaching the minimum or maximum radius limits.

(iv) *Load hoist deceleration device.* The load speed must be automatically reduced prior to the hoist reaching the upper limit. *Temporary alternative measure:* The employer must post a notice in the cab of the crane notifying the operator that the load hoist deceleration device is malfunctioning and instructing the operator to take special care to reduce the load speed when approaching the upper limits.

(v) *Wind speed indicator.* A device must be provided to display the wind speed and must be mounted above the upper rotating structure on tower cranes. On self erecting cranes, it must be mounted at or above the jib level. *Temporary alternative measures:* Use of wind speed information from a properly functioning indicating device on another tower crane on the same site, or a qualified person estimates the wind speed.

(vi) *Load indicating device.* Cranes manufactured after November 8, 2011 must have a device that displays the magnitude of the load on the hook. Displays that are part of load moment limiting devices that display the load on the hook meet this requirement.

Temporary alternative measures: The weight of the load must be determined from a source recognized by the industry (such as the load's manufacturer), or by a calculation method recognized by the industry (such as calculating a steel beam from measured dimensions and a known per foot weight), or by other equally reliable

means. This information must be provided to the operator prior to the lift.

(f) *Inspections.*

(1) Section 1926.1412 (Inspections) applies to tower cranes, except that the term "assembly" is replaced by "erection." Section 1926.1413 (Wire rope—inspection) applies to tower cranes.

(2) *Pre-erection inspection.* Before each crane component is erected, it must be inspected by a qualified person for damage or excessive wear.

(i) The qualified person must pay particular attention to components that will be difficult to inspect thoroughly during shift inspections.

(ii) If the qualified person determines that a component is damaged or worn to the extent that it would create a safety hazard if used on the crane, that component must not be erected on the crane unless it is repaired and, upon reinspection by the qualified person, found to no longer create a safety hazard.

(iii) If the qualified person determines that, though not presently a safety hazard, the component needs to be monitored, the employer must ensure that the component is checked in the monthly inspections. Any such determination must be documented, and the documentation must be available to any individual who conducts a monthly inspection.

(3) *Post-erection inspection.* In addition to the requirements in § 1926.1412(c), the following requirements must be met:

(i) A load test using certified weights, or scaled weights using a certified scale with a current certificate of calibration, must be conducted after each erection.

(ii) The load test must be conducted in accordance with the manufacturer's instructions when available. Where these instructions are unavailable, the test must be conducted in accordance with written load test procedures developed by a registered professional engineer familiar with the type of equipment involved.

(4) *Monthly.* The following additional items must be included:

(i) Tower (mast) bolts and other structural bolts (for loose or dislodged condition) from the base of the tower crane up or, if the crane is tied to or braced by the structure, those above the upper-most brace support.

(ii) The upper-most tie-in, braces, floor supports and floor wedges where the tower crane is supported by the structure, for loose or dislodged components.

(5) *Annual.* In addition to the items that must be inspected under § 1926.1412(f), all turntable and tower

bolts must be inspected for proper condition and torque.

§ 1926.1436 Derricks.

(a) This section contains supplemental requirements for derricks, whether temporarily or permanently mounted; all sections of this subpart apply to derricks unless specified otherwise. A derrick is powered equipment consisting of a mast or equivalent member that is held at or near the end by guys or braces, with or without a boom, and its hoisting mechanism. The mast/equivalent member and/or the load is moved by the hoisting mechanism (typically base-mounted) and operating ropes. Derricks include: A-frame, basket, breast, Chicago boom, gin pole (except gin poles used for erection of communication towers), guy, shearleg, stiffleg, and variations of such equipment.

(b) *Operation—procedures.*

(1) Section 1926.1417 (Operation) applies except for § 1926.1417(c) (Accessibility of procedures).

(2) *Load chart contents.* Load charts must contain at least the following information:

(i) Rated capacity at corresponding ranges of boom angle or operating radii.

(ii) Specific lengths of components to which the rated capacities apply.

(iii) Required parts for hoist reeving.

(iv) Size and construction of rope must be included on the load chart or in the operating manual.

(3) *Load chart location.*

(i) *Permanent installations.* For permanently installed derricks with fixed lengths of boom, guy, and mast, a load chart must be posted where it is visible to personnel responsible for the operation of the equipment.

(ii) *Non-permanent installations.* For derricks that are not permanently installed, the load chart must be readily available at the job site to personnel responsible for the operation of the equipment.

(c) *Construction.*

(1) *General requirements.*

(i) Derricks must be constructed to meet all stresses imposed on members and components when installed and operated in accordance with the manufacturer's/builder's procedures and within its rated capacity.

(ii) Welding of load sustaining members must conform to recommended practices in ANSI/AWS D14.3-94 (incorporated by reference, see § 1926.6) or AWS D1.1/D1.1M:2002 (incorporated by reference, see § 1926.6).

(2) *Guy derricks.*

(i) The minimum number of guys must be 6, with equal spacing, except

where a qualified person or derrick manufacturer approves variations from these requirements and revises the rated capacity to compensate for such variations.

(ii) Guy derricks must not be used unless the employer has the following guy information from the manufacturer or a qualified person, when not available from the manufacturer:

(A) The number of guys.

(B) The spacing around the mast.

(C) The size, grade, and construction of rope to be used for each guy.

(iii) For guy derricks manufactured after December 18, 1970, in addition to the information required in paragraph (c)(2)(ii) of this section, the employer must have the following guy information from the manufacturer or a qualified person, when not available from the manufacturer:

(A) The amount of initial sag or tension.

(B) The amount of tension in guy line rope at anchor.

(iv) The mast base must permit the mast to rotate freely with allowance for slight tilting of the mast caused by guy slack.

(v) The mast cap must:

(A) Permit the mast to rotate freely.

(B) Withstand tilting and cramping caused by the guy loads.

(C) Be secured to the mast to prevent disengagement during erection.

(D) Be provided with means for attaching guy ropes.

(3) *Stiffleg derricks.*

(i) The mast must be supported in the vertical position by at least two stifflegs; one end of each must be connected to the top of the mast and the other end securely anchored.

(ii) The stifflegs must be capable of withstanding the loads imposed at any point of operation within the load chart range.

(iii) The mast base must:

(A) Permit the mast to rotate freely (when necessary).

(B) Permit deflection of the mast without binding.

(iv) The mast must be prevented from lifting out of its socket when the mast is in tension.

(v) The stiffleg connecting member at the top of the mast must:

(A) Permit the mast to rotate freely (when necessary).

(B) Withstand the loads imposed by the action of the stifflegs.

(C) Be secured so as to oppose separating forces.

(4) *Gin pole derricks.*

(i) Guy lines must be sized and spaced so as to make the gin pole stable in both boomed and vertical positions.

Exception: Where the size and/or

spacing of guy lines do not result in the gin pole being stable in both boomed and vertical positions, the employer must ensure that the derrick is not used in an unstable position.

(ii) The base of the gin pole must permit movement of the pole (when necessary).

(iii) The gin pole must be anchored at the base against horizontal forces (when such forces are present).

(5) *Chicago boom derricks.* The fittings for stepping the boom and for attaching the topping lift must be arranged to:

(i) Permit the derrick to swing at all permitted operating radii and mounting heights between fittings.

(ii) Accommodate attachment to the upright member of the host structure.

(iii) Withstand the forces applied when configured and operated in accordance with the manufacturer's/builder's procedures and within its rated capacity.

(iv) Prevent the boom or topping lift from lifting out under tensile forces.

(d) *Anchoring and guying.*

(1) Load anchoring data developed by the manufacturer or a qualified person must be used.

(2) *Guy derricks.*

(i) The mast base must be anchored.

(ii) The guys must be secured to the ground or other firm anchorage.

(iii) The anchorage and guying must be designed to withstand maximum horizontal and vertical forces encountered when operating within rated capacity with the particular guy slope and spacing specified for the application.

(3) *Stiffleg derricks.*

(i) The mast base and stifflegs must be anchored.

(ii) The mast base and stifflegs must be designed to withstand maximum horizontal and vertical forces encountered when operating within rated capacity with the particular stiffleg spacing and slope specified for the application.

(e) *Swingers and hoists.*

(1) The boom, swinger mechanisms and hoists must be suitable for the derrick work intended and must be anchored to prevent displacement from the imposed loads.

(2) *Hoists.*

(i) Base mounted drum hoists must meet the requirements in the following sections of ASME B30.7-2001 (incorporated by reference, *see* § 1926.6):

(A) Sections 7-1.1 ("Load ratings and markings").

(B) Section 7-1.2 ("Construction"), except: 7-1.2.13 ("Operator's cab"); 7-1.2.15 ("Fire extinguishers").

(C) Section 7-1.3 ("Installation").

(D) Applicable terms in section 7-0.2 ("Definitions").

(ii) *Load tests for new hoists.* The employer must ensure that new hoists are load tested to a minimum of 110% of rated capacity, but not more than 125% of rated capacity, unless otherwise recommended by the manufacturer. This requirement is met where the manufacturer has conducted this testing.

(iii) *Repaired or modified hoists.*

Hoists that have had repairs, modifications or additions affecting their capacity or safe operation must be evaluated by a qualified person to determine if a load test is necessary. If it is, load testing must be conducted in accordance with paragraphs (e)(2)(ii) and (iv) of this section.

(iv) *Load test procedure.* Load tests required by paragraphs (e)(2)(ii) or (e)(2)(iii) of this section must be conducted as follows:

(A) The test load must be hoisted a vertical distance to assure that the load is supported by the hoist and held by the hoist brake(s).

(B) The test load must be lowered, stopped and held with the brake(s).

(C) The hoist must not be used unless a competent person determines that the test has been passed.

(f) *Operational aids.*

(1) Section 1926.1416 (Operational aids) applies, except for § 1926.1416(d)(1) (Boom hoist limiting device), § 1926.1416(e)(1) (Boom angle or radius indicator), and § 1926.1416(e)(4) (Load weighing and similar devices).

(2) *Boom angle aid.* A boom angle indicator is not required but if the derrick is not equipped with a functioning one, the employer must ensure that either:

(i) The boom hoist cable must be marked with caution and stop marks.

The stop marks must correspond to maximum and minimum allowable boom angles. The caution and stop marks must be in view of the operator, or a spotter who is in direct communication with the operator; or

(ii) An electronic or other device that signals the operator in time to prevent the boom from moving past its maximum and minimum angles, or automatically prevents such movement, is used.

(3) *Load weight/capacity devices.*

(i) Derricks manufactured more than one year after November 8, 2010 with a maximum rated capacity over 6,000 pounds must have at least one of the following: load weighing device, load moment indicator, rated capacity indicator, or rated capacity limiter.

Temporary alternative measures: The weight of the load must be determined from a source recognized by the industry (such as the load's manufacturer), or by a calculation method recognized by the industry (such as calculating a steel beam from measured dimensions and a known per foot weight), or by other equally reliable means. This information must be provided to the operator prior to the lift. *See* § 1926.1417(j) for additional requirements.

(ii) A load weight/capacity device that is not working properly must be repaired no later than 30 days after the deficiency occurs. *Exception:* If the employer documents that it has ordered the necessary parts within 7 days of the occurrence of the deficiency, and the part is not received in time to complete the repair in 30 days, the repair must be completed within 7 days of receipt of the parts.

(g) *Post-assembly approval and testing—new or reinstalled derricks.*

(1) *Anchorage.*

(i) Anchorages, including the structure to which the derrick is attached (if applicable), must be approved by a qualified person.

(ii) If using a rock or hairpin anchorage, the qualified person must determine if any special testing of the anchorage is needed. If so, it must be tested accordingly.

(2) *Functional test.* Prior to initial use, new or reinstalled derricks must be tested by a competent person with no hook load to verify proper operation. This test must include:

(i) Lifting and lowering the hook(s) through the full range of hook travel.

(ii) Raising and lowering the boom through the full range of boom travel.

(iii) Swinging in each direction through the full range of swing.

(iv) Actuating the anti two-block and boom hoist limit devices (if provided).

(v) Actuating locking, limiting and indicating devices (if provided).

(3) *Load test.* Prior to initial use, new or reinstalled derricks must be load tested by a competent person. The test load must meet the following requirements:

(i) Test loads must be at least 100% and no more than 110% of the rated capacity, unless otherwise recommended by the manufacturer or qualified person, but in no event must the test load be less than the maximum anticipated load.

(ii) The test must consist of:

(A) Hoisting the test load a few inches and holding to verify that the load is supported by the derrick and held by the hoist brake(s).

(B) Swinging the derrick, if applicable, the full range of its swing, at

the maximum allowable working radius for the test load.

(C) Booming the derrick up and down within the allowable working radius for the test load.

(D) Lowering, stopping and holding the load with the brake(s).

(iii) The derrick must not be used unless the competent person determines that the test has been passed.

(4) *Documentation.* Tests conducted under this paragraph must be documented. The document must contain the date, test results and the name of the tester. The document must be retained until the derrick is re-tested or dismantled, whichever occurs first. All such documents must be available, during the applicable document retention period, to all persons who conduct inspections in accordance with § 1926.1412.

(h) *Load testing repaired or modified derricks.* Derricks that have had repairs, modifications or additions affecting the derrick's capacity or safe operation must be evaluated by a qualified person to determine if a load test is necessary. If it is, load testing must be conducted and documented in accordance with paragraph (g) of this section.

(i) [Reserved.]

(j) *Power failure procedures.* If power fails during operations, the derrick operator must safely stop operations. This must include:

(1) Setting all brakes or locking devices.

(2) Moving all clutch and other power controls to the off position.

(k) *Use of winch heads.*

(1) Ropes must not be handled on a winch head without the knowledge of the operator.

(2) While a winch head is being used, the operator must be within reach of the power unit control lever.

(l) [Reserved.]

(m) *Securing the boom.*

(1) When the boom is being held in a fixed position, dogs, pawls, or other positive holding mechanisms on the boom hoist must be engaged.

(2) When taken out of service for 30 days or more, the boom must be secured by one of the following methods:

(i) Laid down.

(ii) Secured to a stationary member, as nearly under the head as possible, by attachment of a sling to the load block.

(iii) For guy derricks, lifted to a vertical position and secured to the mast.

(iv) For stiffleg derricks, secured against the stiffleg.

(n) The process of jumping the derrick must be supervised by the A/D director.

(o) Derrick operations must be supervised by a competent person.

(p) *Inspections.* In addition to the requirements in § 1926.1412, the following additional items must be included in the inspections:

(1) *Daily:* Guys for proper tension.

(2) *Annual.*

(i) Gudgeon pin for cracks, wear, and distortion.

(ii) Foundation supports for continued ability to sustain the imposed loads.

(q) *Qualification and Training.* The employer must train each operator of a derrick on the safe operation of equipment the individual will operate. Section 1926.1427 of this subpart (Operator qualification and certification) does not apply.

§ 1926.1437 Floating cranes/derricks and land cranes/derricks on barges.

(a) This section contains supplemental requirements for floating cranes/derricks and land cranes/derricks on barges, pontoons, vessels or other means of flotation (*i.e.*, vessel/flotation device). The sections of this subpart apply to floating cranes/derricks and land cranes/derricks on barges, pontoons, vessels or other means of flotation, unless specified otherwise. The requirements of this section do not apply when using jacked barges when the jacks are deployed to the river, lake, or sea bed and the barge is fully supported by the jacks.

(b) *General requirements.* The requirements in paragraphs (c) through (k) of this section apply to both floating cranes/derricks and land cranes/derricks on barges, pontoons, vessels or other means of flotation.

(c) *Work area control.*

(1) The requirements of § 1926.1424 (Work area control) apply, except for § 1926.1424(a)(2)(ii).

(2) The employer must either:

(i) Erect and maintain control lines, warning lines, railings or similar barriers to mark the boundaries of the hazard areas; or

(ii) Clearly mark the hazard areas by a combination of warning signs (such as, "Danger—Swing/Crush Zone") and high visibility markings on the equipment that identify the hazard areas. In addition, the employer must train each employee to understand what these markings signify.

(d) *Keeping clear of the load.* Section 1926.1425 does not apply.

(e) *Additional safety devices.* In addition to the safety devices listed in § 1926.1415, the following safety devices are required:

(1) Barge, pontoon, vessel or other means of flotation list and trim device. The safety device must be located in the cab or, when there is no cab, at the operator's station.

(2) Positive equipment house lock.

(3) *Wind speed and direction indicator.* A competent person must determine if wind is a factor that needs to be considered; if wind needs to be considered, a wind speed and direction indicator must be used.

(f) *Operational aids.*

(1) An anti two-block device is required only when hoisting personnel or hoisting over an occupied cofferdam or shaft.

(2) Section 1926.1416(e)(4) (Load weighing and similar devices) does not apply to dragline, clamshell (grapple), magnet, drop ball, container handling, concrete bucket, and pile driving work performed under this section.

(g) *Accessibility of procedures applicable to equipment operation.* If the crane/derrick has a cab, the requirements of § 1926.1417(c) apply. If the crane/derrick does not have a cab, the employer must ensure that:

(1) Rated capacities (load charts) are posted at the operator's station. If the operator's station is moveable (such as with pendant-controlled equipment), the load charts are posted on the equipment.

(2) Procedures applicable to the operation of the equipment (other than load charts), recommended operating speeds, special hazard warnings, instructions and operators manual, must be readily available on board the vessel/flotation device.

(h) *Inspections.* In addition to meeting the requirements of § 1926.1412 for inspecting the crane/derrick, the employer must inspect the barge, pontoons, vessel or other means of flotation used to support a floating crane/derrick or land crane/derrick, and ensure that:

(1) *Shift.* For each shift inspection, the means used to secure/attach the equipment to the vessel/flotation device is in proper condition, including wear, corrosion, loose or missing fasteners, defective welds, and (when applicable) insufficient tension.

(2) *Monthly.* For each monthly inspection:

(i) The means used to secure/attach the equipment to the vessel/flotation device is in proper condition, including inspection for wear, corrosion, and, when applicable, insufficient tension.

(ii) The vessel/flotation device is not taking on water.

(iii) The deckload is properly secured.

(iv) The vessel/flotation device is watertight based on the condition of the chain lockers, storage, fuel compartments, and hatches.

(v) The firefighting and lifesaving equipment is in place and functional.

(3) The shift and monthly inspections are conducted by a competent person, and:

(i) If any deficiency is identified, an immediate determination is made by a qualified person whether the deficiency constitutes a hazard.

(ii) If the deficiency is determined to constitute a hazard, the vessel/flotation device is removed from service until the deficiency has been corrected.

(4) *Annual: external vessel/flotation device inspection.* For each annual inspection:

(i) The external portion of the barge, pontoons, vessel or other means of flotation used is inspected annually by a qualified person who has expertise with respect to vessels/flotation devices and that the inspection includes the following items:

(A) The items identified in paragraphs (h)(1) (*Shift*) and (h)(2) (*Monthly*) of this section.

(B) Cleats, bits, chocks, fenders, capstans, ladders, and stanchions, for significant corrosion, wear, deterioration, or deformation that could impair the function of these items.

(C) External evidence of leaks and structural damage; evidence of leaks and damage below the waterline may be determined through internal inspection of the vessel/flotation device.

(D) Four-corner draft readings.

(E) Firefighting equipment for serviceability.

(ii) Rescue skiffs, lifelines, work vests, life preservers and ring buoys are inspected for proper condition.

(iii) If any deficiency is identified, an immediate determination is made by the qualified person whether the deficiency constitutes a hazard or, though not yet a hazard, needs to be monitored in the monthly inspections.

(A) If the qualified person determines that the deficiency constitutes a hazard, the vessel/flotation device is removed from service until it has been corrected. See requirements in § 1926.1417(f).

(B) If the qualified person determines that, though not presently a hazard, the deficiency needs to be monitored, the deficiency is checked in the monthly inspections.

(5) *Four-year: internal vessel/flotation device inspection.* For each four-year inspection:

(i) A marine engineer, marine architect, licensed surveyor, or other qualified person who has expertise with respect to vessels/flotation devices surveys the internal portion of the barge, pontoons, vessel, or other means of flotation.

(ii) If the surveyor identifies a deficiency, an immediate determination is made by the surveyor as to whether

the deficiency constitutes a hazard or, though not yet a hazard, needs to be monitored in the monthly or annual inspections, as appropriate.

(A) If the surveyor determines that the deficiency constitutes a hazard, the vessel/flotation device is removed from service until it has been corrected.

(B) If the surveyor determines that, though not presently a hazard, the deficiency needs to be monitored, the deficiency is checked in the monthly or annual inspections, as appropriate.

(6) *Documentation.* The monthly and annual inspections required in paragraphs (h)(2) and (h)(4) of this section are documented in accordance with §§ 1926.1412 (e)(3) and 1926.1412(f)(7), respectively, and that the four-year inspection required in paragraph (h)(5) of this section is documented in accordance with § 1926.1412(f)(7), except that the documentation for that inspection must be retained for a minimum of 4 years. All such documents must be made available, during the applicable document retention period, to all persons who conduct inspections in accordance with § 1926.1412.

(i) [*Reserved.*]

(j) *Working with a diver.* The employer must meet the following additional requirements when working with a diver in the water:

(1) If a crane/derrick is used to get a diver into and out of the water, it must not be used for any other purpose until the diver is back on board. When used for more than one diver, it must not be used for any other purpose until all divers are back on board.

(2) The operator must remain at the controls of the crane/derrick at all times.

(3) In addition to the requirements in §§ 1926.1419 through 1926.1422 (Signals), either:

(i) A clear line of sight must be maintained between the operator and tender; or

(ii) The signals between the operator and tender must be transmitted electronically.

(4) The means used to secure the crane/derrick to the vessel/flotation device (see paragraph (n)(5) of this section) must not allow any amount of shifting in any direction.

(k) Manufacturer's specifications and limitations.

(1) The employer must ensure that the barge, pontoons, vessel, or other means of flotation must be capable of withstanding imposed environmental, operational and in-transit loads when used in accordance with the manufacturer's specifications and limitations.

(2) The employer must ensure that the manufacturer's specifications and limitations with respect to environmental, operational, and in-transit loads for a barge, pontoon, vessel, or other means of flotation are not exceeded or violated.

(3) When the manufacturer's specifications and limitations are unavailable, the employer must ensure that the specifications and limitations established by a qualified person with respect to environmental, operational and in-transit loads for the barge, pontoons, vessel, or other means of flotation are not exceeded or violated.

(l) [*Reserved.*]

(m) *Floating cranes/derricks.* For equipment designed by the manufacturer (or employer) for marine use by permanent attachment to barges, pontoons, vessels or other means of flotation:

(1) *Load charts.*

(i) The employer must not exceed the manufacturer load charts applicable to operations on water. When using these charts, the employer must comply with all parameters and limitations (such as dynamic and environmental parameters) applicable to the use of the charts.

(ii) The employer must ensure that load charts take into consideration a minimum wind speed of 40 miles per hour.

(2) The employer must ensure that the requirements for maximum allowable list and maximum allowable trim as specified in Table M1 of this section are met.

TABLE M1

Rated capacity	Maximum allowable list (degrees)	Maximum allowable trim (degrees)
<i>Equipment designed for marine use by permanent attachment (other than derricks):</i>		
25 tons or less	5	5
Over 25 tons	7	7
<i>Derricks designed for marine use by permanent attachment:</i>		
Any rated capacity	10	10

(3) The employer must ensure that the equipment is stable under the conditions specified in Tables M2 and M3 of this section. (**Note:** Freeboard is the vertical distance between the water line and the main deck of the vessel.)

TABLE M2

Operated at	Wind speed (mph)	Minimum freeboard (ft)
Rated capacity	60	2
Rated capacity plus 25%	60	1
High boom, no load ..	60	2

TABLE M3

Operated at	Wind speed
For backward stability of the boom: High boom, no load, full back list (least stable condition).	90 mph.

(4) If the equipment is employer-made, it must not be used unless the employer has documents demonstrating that the load charts and applicable parameters for use meet the requirements of paragraphs (m)(1) through (3) of this section. Such documents must be signed by a registered professional engineer who is a qualified person with respect to the design of this type of equipment (including the means of flotation).

(5) The employer must ensure that the barge, pontoons, vessel or other means of flotation used:

(i) Are structurally sufficient to withstand the static and dynamic loads of the crane/derrick when operating at the crane/derrick's maximum rated capacity with all planned and actual deck loads and ballasted compartments.

(ii) Have a subdivided hull with one or more longitudinal watertight bulkheads for reducing the free-surface effect.

(iii) Have access to void compartments to allow for inspection and pumping.

(n) *Land cranes/derricks.* For land cranes/derricks used on barges, pontoons, vessels or other means of flotation, the employer must ensure that:

(1) The rated capacity of the equipment (including but not limited to modification of load charts) applicable for use on land is reduced to:

(i) Account for increased loading from list, trim, wave action, and wind.

(ii) Be applicable to a specified location(s) on the specific barge, pontoons, vessel or other means of flotation that will be used, under the environmental conditions expected and encountered.

(iii) The conditions required in paragraphs (n)(3) and (n)(4) of this section are met.

(2) The rated capacity modification required in paragraph (n)(1) of this

section is performed by the equipment manufacturer, or a qualified person who has expertise with respect to both land crane/derrick capacity and the stability of vessels/flotation devices.

(3) For list and trim.

(i) The maximum allowable list and the maximum allowable trim for the barge, pontoon, vessel or other means of flotation must not exceed the amount necessary to ensure that the conditions in paragraph (n)(4) of this section are met. In addition, the maximum allowable list and the maximum allowable trim does not exceed the least of the following: 5 degrees, the amount specified by the crane/derrick manufacturer, or, when, an amount is not so specified, the amount specified by the qualified person.

(ii) The maximum allowable list and the maximum allowable trim for the land crane/derrick does not exceed the amount specified by the crane/derrick manufacturer, or, when, an amount is not so specified, the amount specified by the qualified person.

(4) For the following conditions:

(i) All deck surfaces of the barge, pontoons, vessel or other means of flotation used are above water.

(ii) The entire bottom area of the barge, pontoons, vessel or other means of flotation used is submerged.

(5) Physical attachment, corraling, rails system and centerline cable system meet the requirements in Option (1), Option (2), Option (3), or Option (4) of this section, and that whichever option is used also meets the requirements of paragraph (n)(5)(v) of this section.

(i) *Option (1)—Physical attachment.* The crane/derrick is physically attached to the barge, pontoons, vessel or other means of flotation. Methods of physical attachment include crossed-cable systems attached to the crane/derrick and vessel/flotation device, bolting or welding the crane/derrick to the vessel/flotation device, strapping the crane/derrick to the vessel/flotation device with chains, or other methods of physical attachment.

(ii) *Option (2)—Corraling.* The crane/derrick is prevented from shifting by installing barricade restraints (*i.e.*, a corraling system). Employers must ensure that corraling systems do not allow the equipment to shift by any amount of shifting in any direction.

(iii) *Option (3)—Rails.* The crane/derrick must be prevented from shifting by being mounted on a rail system. Employers must ensure that rail clamps and rail stops are used unless the system is designed to prevent movement during operation by other means.

(iv) *Option (4)—Centerline cable system.* The crane/derrick is prevented

from shifting by being mounted to a wire rope system. The employer must ensure that the wire rope system meets the following requirements:

(A) The wire rope and attachments are of sufficient size and strength to support the side load of crane/derrick.

(B) The wire rope is attached physically to the vessel/flotation device.

(C) The wire rope is attached to the crane/derrick by appropriate attachment methods (such as shackles or sheaves) on the undercarriage, and that the method used will allow the crew to secure the crane/derrick from movement during operation and to move the crane/derrick longitudinally along the vessel/flotation device for repositioning.

(D) Means are installed to prevent the crane/derrick from passing the forward or aft end of the wire rope attachments.

(E) The crane/derrick is secured from movement during operation.

(v) The systems/means used to comply with Option (1), Option (2), Option (3), or Option (4) of this section are designed by a marine engineer, registered professional engineer familiar with floating crane/derrick design, or qualified person familiar with floating crane/derrick design.

(6) *Exception.* For mobile auxiliary cranes used on the deck of a floating crane/derrick, the requirement specified by paragraph (n)(5) of this section to use Option (1), Option (2), Option (3), or Option (4) does not apply when the employer demonstrates implementation of a plan and procedures that meet the following requirements:

(i) A marine engineer or registered professional engineer familiar with floating crane/derrick design develops and signs a written plan for the use of the mobile auxiliary crane.

(ii) The plan is designed so that the applicable requirements of this section are met despite the position, travel, operation, and lack of physical attachment (or corraling, use of rails or cable system) of the mobile auxiliary crane.

(iii) The plan specifies the areas of the deck where the mobile auxiliary crane is permitted to be positioned, travel, and operate, and the parameters and limitations of such movements and operation.

(iv) The deck is marked to identify the permitted areas for positioning, travel, and operation.

(v) The plan specifies the dynamic and environmental conditions that must be present for use of the plan.

(vi) If the dynamic and environmental conditions in paragraph (n)(6)(v) of this section are exceeded, the mobile auxiliary crane is attached physically or corralled in accordance with Option (1),

Option (2) or Option (4) of paragraph (n)(5) of this section.

(7) The barge, pontoons, vessel or other means of flotation used:

(i) Are structurally sufficient to withstand the static and dynamic loads of the crane/derrick when operating at the crane/derrick's maximum rated capacity with all anticipated deck loads and ballasted compartments.

(ii) Have a subdivided hull with one or more longitudinal watertight bulkheads for reducing the free surface effect.

(iii) Have access to void compartments to allow for inspection and pumping.

§ 1926.1438 Overhead & gantry cranes.

(a) *Permanently installed overhead and gantry cranes.* The requirements of § 1910.179, except for § 1910.179(b)(1), and not the requirements of this subpart CC, apply to the following equipment when used in construction and permanently installed in a facility: overhead and gantry cranes, including semigantry, cantilever gantry, wall cranes, storage bridge cranes, and others having the same fundamental characteristics.

(b) *Overhead and gantry cranes that are not permanently installed in a facility.*

(1) This paragraph applies to the following equipment when used in construction and not permanently installed in a facility: Overhead and gantry cranes, overhead/bridge cranes, semigantry, cantilever gantry, wall cranes, storage bridge cranes, launching gantry cranes, and similar equipment having the same fundamental characteristics, irrespective of whether it travels on tracks, wheels, or other means.

(2) The following requirements apply to equipment identified in paragraph (b)(1) of this section:

(i) Sections 1926.1400 through 1926.1414; §§ 1926.1417 through 1926.1425; § 1926.1426(d), §§ 1926.1427 through 1926.1434; § 1926.1437, § 1926.1439, and § 1926.1441.

(ii) The following portions of § 1910.179:

(A) Paragraphs (b)(5),(6),(7); (e)(1),(3),(5),(6); (f)(1),(4); (g); (h)(1),(3); (k); and (n) of § 1910.179.

(B) The definitions in § 1910.179(a) except for "hoist" and "load." For those words, the definitions in § 1926.1401 apply.

(C) Section 1910.179(b)(2), but only where the equipment identified in paragraph (b)(1) of this section (§ 1926.1438) was manufactured before September 19, 2001.

(iii) For equipment manufactured on or after September 19, 2001, the

following sections of ASME B30.2–2005 (incorporated by reference, *see* § 1926.6) apply: 2–1.3.1; 2–1.3.2; 2–1.4.1; 2–1.6; 2–1.7.2; 2–1.8.2; 2–1.9.1; 2–1.9.2; 2–1.11; 2–1.12.2; 2–1.13.7; 2–1.14.2; 2–1.14.3; 2–1.14.5; 2–1.15.; 2–2.2.2; 2–3.2.1.1. In addition, 2–3.5 applies, except in 2–3.5.1(b), "29 CFR 1910.147" is substituted for "ANSI Z244.1."

§ 1926.1439 Dedicated pile drivers.

(a) The provisions of subpart CC apply to dedicated pile drivers, except as specified in this section.

(b) Section 1926.1416(d)(3) (Anti two-blocking device) does not apply.

(c) Section 1926.1416(e)(4) (Load weighing and similar devices) applies only to dedicated pile drivers manufactured after November 8, 2011.

(d) In § 1926.1433, only §§ 1926.1433(d) and (e) apply to dedicated pile drivers.

§ 1926.1440 Sideboom cranes.

(a) The provisions of this standard apply, except § 1926.1402 (Ground conditions), § 1926.1415 (Safety devices), § 1926.1416 (Operational aids), and § 1926.1427 (Operator qualification and certification).

(b) Section 1926.1426 (Free fall and controlled load lowering) applies, except § 1926.1426(a)(2)(i). Sideboom cranes in which the boom is designed to free fall (live boom) are permitted only if manufactured prior to November 8, 2010.

(c) Sideboom cranes mounted on wheel or crawler tractors must meet all of the following requirements of ASME B30.14–2004 (incorporated by reference, *see* § 1926.6):

(1) Section 14–1.1 ("Load Ratings").

(2) Section 14–1.3 ("Side Boom Tractor Travel").

(3) Section 14–1.5 ("Ropes and Reeving Accessories").

(4) Section 14–1.7.1 ("Booms").

(5) Section 14–1.7.2 ("General Requirements—Exhaust Gases").

(6) Section 14–1.7.3 ("General Requirements—Stabilizers (Wheel-Type Side Boom Tractors)").

(7) Section 14–1.7.4 ("General Requirements—Welded Construction").

(8) Section 14–1.7.6 ("General Requirements—Clutch and Brake Protection").

(9) Section 14–2.2.2 ("Testing—Rated Load Test"), except that it applies only to equipment that has been altered or modified.

(10) In section 14–3.1.2 ("Operator Qualifications"), paragraph (a), except the phrase "When required by law."

(11) In section 14–3.1.3 ("Operating Practices"), paragraphs (e), (f)(1)—(f)(4), (f)(6), (f)(7), (h), and (i).

(12) In section 14–3.2.3 ("Moving the Load"), paragraphs (j), (l), and (m).

§ 1926.1441 Equipment with a rated hoisting/lifting capacity of 2,000 pounds or less.

The following paragraphs of this section specify requirements for employers using equipment with a maximum rated hoisting/lifting capacity of 2,000 pounds or less.

(a) The employer using this equipment must comply with the following provisions of this subpart: § 1926.1400 (Scope); § 1926.1401 (Definitions); § 1926.1402 (Ground conditions); § 1926.1403 (Assembly/disassembly—selection of manufacturer or employer procedures); § 1926.1406 (Assembly/disassembly—employer procedures); §§ 1926.1407 through 1926.1411 (Power line safety); § 1926.1412(c) (*Post-assembly*); §§ 1926.1413 through 1926.1414 (Wire rope); § 1926.1418 (Authority to stop operation); §§ 1926.1419 through 1926.1422 (Signals); § 1926.1423 (Fall protection); § 1926.1425 (Keeping clear of the load) (except for § 1926.1425(c)(3) (qualified rigger)); § 1926.1426 (Free fall and controlled load lowering); § 1926.1432 (Multiple crane/derrick lifts—supplemental requirements); § 1926.1434 (Equipment modifications); § 1926.1435 (Tower cranes); § 1926.1436 (Derricks); § 1926.1437 (Floating cranes/derricks and land cranes/derricks on barges); § 1926.1438 (Overhead & gantry cranes).

(b) *Assembly/disassembly.*

(1) In addition to compliance with §§ 1926.1403 (Assembly/disassembly—selection of manufacturer or employer procedures) and 1926.1406 (Assembly/disassembly—employer procedures), the employer must also comply with § 1926.1441(b)(2)–(3).

(2) *Components and configuration.*

The employer must ensure that:

(i) The selection of components, and the configuration of the equipment, that affect the capacity or safe operation of the equipment complies with either the:

(A) Manufacturer instructions, recommendations, limitations, and specifications. When these documents and information are unavailable, a registered professional engineer familiar with the type of equipment involved must approve, in writing, the selection and configuration of components; or

(B) Approved modifications that meet the requirements of § 1926.1434 (Equipment modifications).

(ii) *Post-assembly inspection.* Upon completion of assembly, the equipment is inspected to ensure that it is in compliance with paragraph (b)(2)(i) of

this section (see § 1926.1412(c) for post-assembly inspection requirements).

(3) *Manufacturer prohibitions.* The employer must comply with applicable manufacturer prohibitions.

(c) *Operation—procedures.*

(1) The employer must comply with all manufacturer procedures applicable to the operational functions of the equipment, including its use with attachments.

(2) *Unavailable operation procedures.* The employer must:

(i) When the manufacturer's procedures are unavailable, develop, and ensure compliance with, all procedures necessary for the safe operation of the equipment and attachments.

(ii) Ensure that procedures for the operational controls are developed by a qualified person.

(iii) Ensure that procedures related to the capacity of the equipment are developed and signed by a registered professional engineer familiar with the equipment.

(3) *Accessibility.* The employer must ensure that:

(i) The load chart is available to the operator at the control station;

(ii) Procedures applicable to the operation of the equipment,

recommended operating speeds, special hazard warnings, instructions, and operator's manual are readily available for use by the operator.

(iii) When rated capacities are available at the control station only in electronic form and a failure occurs that makes the rated capacities inaccessible, the operator immediately ceases operations or follows safe shut-down procedures until the rated capacities (in electronic or other form) are available.

(d) *Safety devices and operational aids.*

(1) The employer must ensure that safety devices and operational aids that are part of the original equipment are maintained in accordance with manufacturer procedures.

(2) *Anti two-blocking.* The employer must ensure that equipment covered by this section manufactured more than one year after November 8, 2010 have either an anti two-block device that meets the requirements of § 1926.1416(d)(3), or is designed so that, in the event of a two-block situation, no damage or load failure will occur (for example, by using a power unit that stalls in response to a two-block situation).

(e) *Operator qualifications.* The employer must train each operator, prior

to operating the equipment, on the safe operation of the type of equipment the operator will be using.

(f) *Signal person qualifications.* The employer must train each signal person in the proper use of signals applicable to the use of the equipment.

(g) [Reserved.]

(h) *Inspections.* The employer must ensure that equipment is inspected in accordance with manufacturer procedures.

(i) [Reserved.]

(j) *Hoisting personnel.* The employer must ensure that equipment covered by this section is not used to hoist personnel.

(k) *Design.* The employer must ensure that the equipment is designed by a qualified engineer.





§ 1926.1442 Severability.



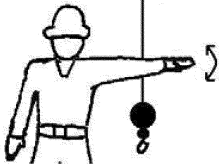

Should a court of competent jurisdiction hold any provision(s) of subpart CC to be invalid, such action shall not affect any other provision of the subpart.

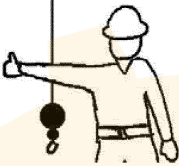
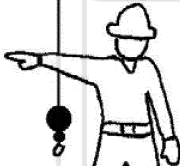
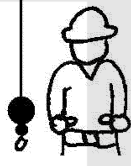
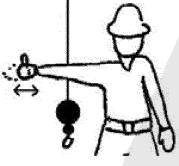
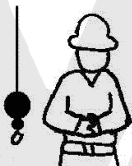
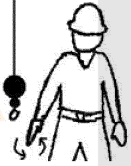
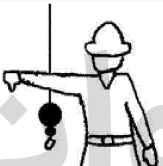
BILLING CODE 4510-26-P

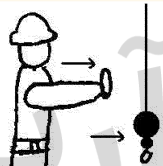
Appendix A to Subpart CC of Part 1926—Standard Hand Signals

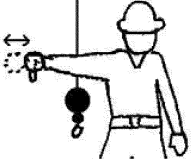
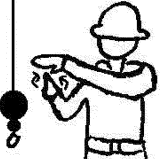
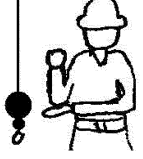
آریا ایمن آوات

 <p>STOP – With arm extended horizontally to the side, palm down, arm is swung back and forth.</p>	 <p>EMERGENCY STOP – With both arms extended horizontally to the side, palms down, arms are swung back and forth.</p>	 <p>HOIST – With upper arm extended to the side, forearm and index finger pointing straight up, hand and finger make small circles.</p>
 <p>RAISE BOOM – With arm extended horizontally to the side, thumb points up with other fingers closed.</p>	 <p>SWING – With arm extended horizontally, index finger points in direction that boom is to swing.</p>	 <p>RETRACT TELESCOPING BOOM – With hands to the front at waist level, thumbs point at each other with other fingers closed.</p>
 <p>RAISE THE BOOM AND LOWER THE LOAD – With arm extended horizontally to the side and thumb pointing up, fingers open and close while load movement is desired.</p>	 <p>DOG EVERYTHING – Hands held together at waist level.</p>	 <p>LOWER – With arm and index finger pointing down, hand and finger make small circles.</p>
 <p>LOWER BOOM – With arm extended horizontally to the side, thumb points down with other fingers closed.</p>	 <p>EXTEND TELESCOPING BOOM – With hands to the front at waist level, thumbs point outward with other fingers closed.</p>	 <p>TRAVEL/TOWER TRAVEL – With all fingers pointing up, arm is extended horizontally out and back to make a pushing motion in the direction of travel.</p>

 <p>LOWER THE BOOM AND RAISE THE LOAD – With arm extended horizontally to the side and thumb pointing down, fingers open and close while load movement is desired.</p>	 <p>MOVE SLOWLY – A hand is placed in front of the hand that is giving the action signal.</p>	 <p>USE AUXILIARY HOIST (whipline) – With arm bent at elbow and forearm vertical, elbow is tapped with other hand. Then regular signal is used to indicate desired action.</p>
 <p>CRAWLER CRANE TRAVEL, BOTH TRACKS – Rotate fists around each other in front of body; direction of rotation away from body indicates travel forward; rotation towards body indicates travel backward.</p>	 <p>USE MAIN HOIST – A hand taps on top of the head. Then regular signal is given to indicate desired action.</p>	 <p>CRAWLER CRANE TRAVEL, ONE TRACK – Indicate track to be locked by raising fist on that side. Rotate other fist in front of body in direction that other track is to travel.</p>
 <p>TROLLEY TRAVEL – With palm up, fingers closed and thumb pointing in direction of motion, hand is jerked horizontally in direction trolley is to travel.</p>		

Appendix B to Subpart CC of Part 1926—Assembly/Disassembly: Sample Procedures for Minimizing the Risk of Unintended Dangerous Boom Movement

1. Section 1926.1404(f)(1) provides that when pins (or similar devices) are being removed, employees must not be under the boom, jib, or other components, except where the requirements of § 1926.1404(f)(2) are met. The exception in § 1926.1404(f)(2) applies when the employer demonstrates that site constraints require one or more employees to be under the boom, jib, or other components when pins (or similar devices) are being removed. In such a situation, the A/D director must implement procedures that minimize the risk of unintended dangerous movement and minimize the duration and extent of exposure under the boom.

The following scenario is an example of how the exception applies: A boom cannot be disassembled on the ground because of aboveground piping (as might be found, for example, in an oil refinery) that precludes lowering the boom to the ground. The boom must therefore be disassembled in the air, and the employees who remove the pins must perform that work from an aerial lift whose base is positioned on one side (the near side) of the boom. To gain access to the pins on the far side, the aerial lift basket must move under the boom, since, due to lack of room, the aerial lift cannot be repositioned on the far side. Due to lack of room, the aerial lift cannot be repositioned on the far side, so the aerial basket must move under the boom to gain access to the pins on the far side.

To minimize the risk of unintended dangerous movement while the pins are removed, the A/D director uses an assist

crane that is rigged to support the boom section that is being detached, using particular care to ensure that the section end that is near the employee(s) removing the pins is well supported. The duration and extent of exposure is minimized by removing the far side pins first, moving the aerial lift basket as soon as possible to the near side so that the employees are no longer under the boom, and then removing the near side pins.

2. Section 1926.1404(h)(6)(i) provides that, during assembly/disassembly, the center of gravity of the load must be identified if that is necessary for the method used for maintaining stability. Section 1926.1404(h)(6)(ii) states that, where there is insufficient information to accurately identify the center of gravity, measures designed to prevent unintended dangerous movement resulting from an inaccurate

identification of the center of gravity must be used.

An example of the application of § 1926.1404(h)(6)(ii) is as follows: The boom is assembled by lowering boom sections sequentially into place using an assist crane. The A/D director's plan is to keep the boom sections stable while they are lowered into place by attaching the assist crane hoist line above the center of gravity of each section. However, in assembling the non-symmetrical top section of the boom, the A/D director is not able to determine where to attach the assist crane hoist line so that it is above the center of gravity. In this situation, before raising the section, all personnel are kept clear of the section and the section is first raised a few inches to determine whether it tips when raised (if it did tip, it would indicate it is not rigged over the center of gravity). If this occurs, the hoist line is repositioned and the procedure repeated (with employees kept clear of the section while it is raised) until the A/D director determines that it is rigged over the center of gravity and can be moved into place without dangerous movement.

Appendix C to Subpart CC of Part 1926—Operator Certification: Written Examination: Technical Knowledge Criteria

This appendix contains information for employers, accredited testing organizations, auditors and government entities developing criteria for a written examination to test an individual's technical knowledge relating to the operation of cranes.

- (a) General technical information.
- (1) The functions and limitations of the crane and attachments.
 - (2) Wire rope:
 - (i) Background information necessary to understand the inspection and removal from service criteria in § 1926.1413 and § 1926.1414.
 - (ii) Capacity and when multi-part rope is needed.
 - (iii) Relationship between line pull and safe working load.
 - (iv) How to determine the manufacturer's recommended rope for the crane.
 - (3) Rigging devices and their use, such as:
 - (i) Slings.
 - (ii) Spreaders.
 - (iii) Lifting beams.
 - (iv) Wire rope fittings, such as clips, shackles and wedge sockets.
 - (v) Saddles (softeners).
 - (vi) Clamps (beams).
 - (4) The technical limitations of protective measures against electrical hazards:
 - (i) Grounding.
 - (ii) Proximity warning devices.
 - (iii) Insulated links.
 - (iv) Boom cages.
 - (v) Proximity to electric power lines, radii, and microwave structures.
 - (5) The effects of load share and load transfer in multi-crane lifts.
 - (6) Basic crane terms.
 - (7) The basics of machine power flow systems.
 - (i) Mechanical.
 - (ii) Electrical.
 - (iii) Pneumatic.

- (iv) Hydraulic.
- (v) Combination.
- (8) The significance of the instruments and gauge readings.
- (9) The effects of thermal expansion and contraction in hydraulic cylinders.
- (10) Background information necessary to understand the requirements of pre-operation and inspection.
- (11) How to use the safety devices and operational aids required under § 1926.1415 and § 1926.1416.
- (12) The difference between duty-cycle and lifting operations.
- (13) How to calculate net capacity for every possible configuration of the equipment using the manufacturer's load chart.
- (14) How to use manufacturer-approved attachments and their effect on the equipment.
- (15) How to obtain dimensions, weight, and center of gravity of the load.
- (16) The effects of dynamic loading from:
 - (i) Wind.
 - (ii) Stopping and starting.
 - (iii) Impact loading.
 - (iv) Moving with the load.
 - (v) The effect of side loading.
- (17) The principles of backward stability.
- (b) Site information.
 - (1) How to identify the suitability of the supporting ground/surface to support the expected loads of the operation. Elements include:
 - (i) Weaknesses below the surface (such as voids, tanks, loose fill).
 - (ii) Weaknesses on the surface (such as retaining walls, slopes, excavations, depressions).
 - (2) Proper use of mats, blocking/cribbing, outriggers, stabilizers, or crawlers.
 - (3) Identification of site hazards such as power lines, piping, and traffic.
 - (4) How to review operation plans with supervisors and other workers (such as the signal person), including how to determine working height, boom length, load radius, and travel clearance.
 - (5) How to determine if there is adequate room for extension of crawlers or outriggers/stabilizers and counterweights.
- (c) Operations.
 - (1) How to pick, carry, swing and place the load smoothly and safely on rubber tires and on outriggers/stabilizers or crawlers (where applicable).
 - (2) How to communicate at the site with supervisors, the crew and the signal person.
 - (3) Proper procedures and methods of reeving wire ropes and methods of reeving multiple-part lines and selecting the proper load block and/or ball.
 - (4) How to react to changes in conditions that affect the safe operation of the equipment.
 - (5) How to shut down and secure the equipment properly when leaving it unattended.
 - (6) Know how to apply the manufacturer's specifications for operating in various weather conditions, and understand how environmental conditions affect the safe operation of the equipment.
 - (7) How to properly level the equipment.
 - (8) How to verify the weight of the load and rigging prior to initiating the lift.

- (9) How to determine where the load is to be picked up and placed and how to verify the radii.
- (10) Know basic rigging procedures.
- (11) How to carry out the shift inspection required in this subpart.
- (12) Know that the following operations require specific procedures and skill levels:
 - (i) Multi-crane lifts.
 - (ii) Hoisting personnel.
 - (iii) Clamshell/dragline operations.
 - (iv) Pile driving and extracting.
 - (v) Concrete operations, including poured-in-place and tilt-up.
 - (vi) Demolition operations.
 - (vii) Operations on water.
 - (viii) Magnet operations.
 - (ix) Multi-drum operations.
- (13) Know the proper procedures for operating safely under the following conditions:
 - (i) Traveling with suspended loads.
 - (ii) Approaching a two-block condition.
 - (iii) Operating near power lines.
 - (iv) Hoisting personnel.
 - (v) Using other than full outrigger/crawler or stabilizer extensions.
 - (vi) Lifting loads from beneath the surface of the water.
 - (vii) Using various approved counterweight configurations.
 - (viii) Handling loads out of the operator's vision ("operating in the blind").
 - (ix) Using electronic communication systems for signal communication.
- (14) Know the proper procedures for load control and the use of hand-held tag lines.
- (15) Know the emergency response procedure for:
 - (i) Fires.
 - (ii) Power line contact.
 - (iii) Loss of stability.
 - (iv) Control malfunction.
 - (v) Two-blocking.
 - (vi) Overload.
 - (vii) Carrier or travel malfunction.
- (16) Know how to properly use outriggers and stabilizers in accordance with manufacturer specifications.
 - (d) Use of load charts.
 - (1) Know the terminology necessary to use load charts.
 - (2) Know how to ensure that the load chart is the appropriate chart for the equipment in its particular configuration and application.
 - (3) Know how to use load charts. This includes knowing:
 - (i) The operational limitations of load charts and footnotes.
 - (ii) How to relate the chart to the configuration of the crane, crawlers, or outriggers/stabilizers extended or retracted, jib erected or offset, and various counterweight configurations.
 - (iii) The difference between structural capacity and capacity limited by stability.
 - (iv) What is included in capacity ratings.
 - (v) The range diagram and its relationship to the load chart.
 - (vi) The work area chart and its relationship to the load chart.
 - (vii) Where to find and how to use the "parts-of-line" information.

(4) Know how to use the load chart together with the load indicators and/or load moment devices.

[FR Doc. 2010-17818 Filed 7-28-10; 8:45 am]

BILLING CODE 4510-26-P

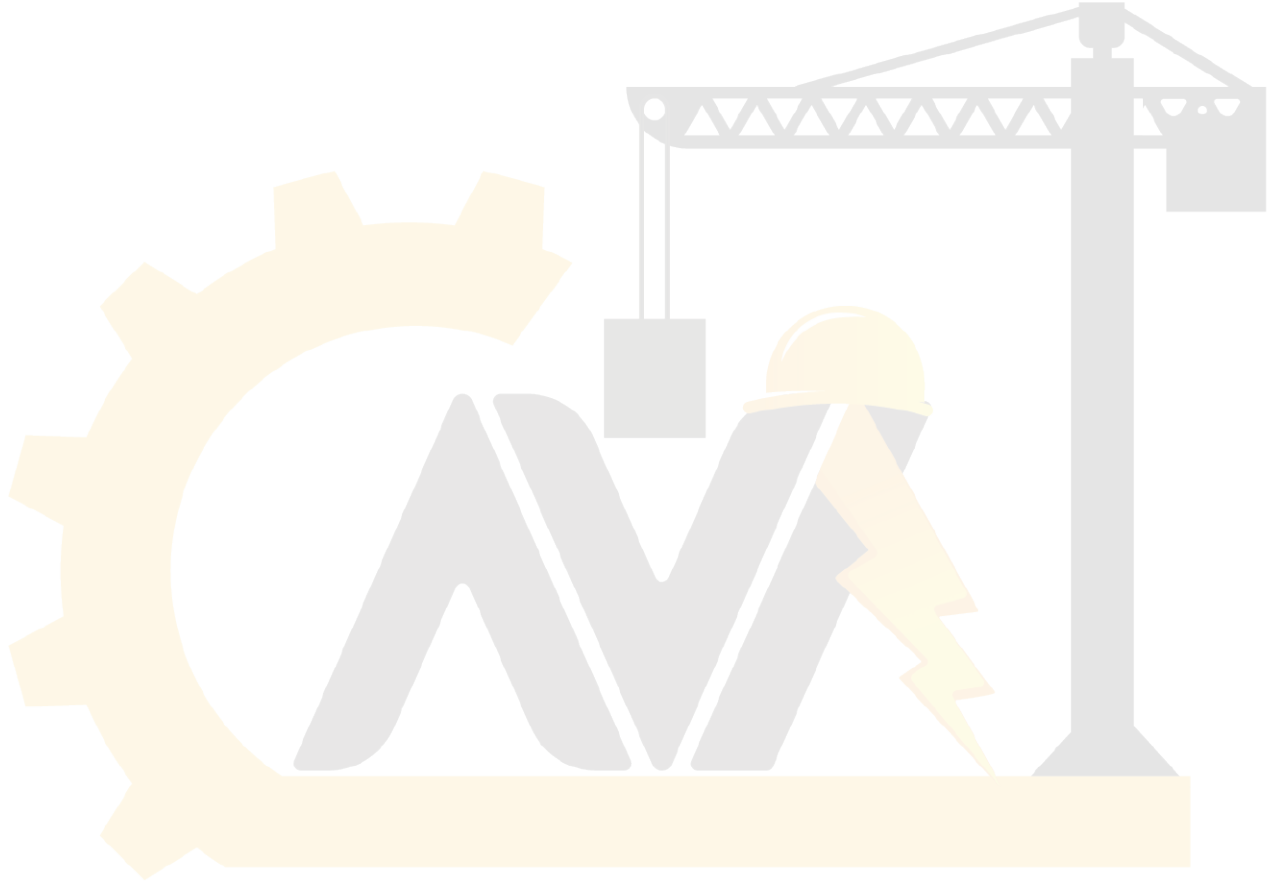

آریا ایمن آوات

Guidelines for Hoisting and Rigging Activity

The U.S. Department of Energy (DOE) *Hoisting and Rigging Standard, DOE-STD-1090-2001*, is intended as a reference document to be used by supervisors, line managers, safety personnel, equipment operators, and any other personnel responsible for safety of hoisting and rigging. Although DOE-STD-1090-2001 was established for operations at DOE sites, other employer sites may also benefit from relevant information and applicable standards or guidelines it offers, therefore various sections have been condensed/consolidated and provided.

DOE is owner and primary user of DOE-STD-1090-2001, which is available on the internet and in public domain. It offers a significant amount of information and guidelines applicable to many other employers or personnel involved in hoisting and rigging activity. DOE-STD-1090-2001 has 17 chapters, subdivided into 10 parts (sample table of content provided on next page). Material provided here has same number sequence as source document, however, all chapters or sections within the document are not addressed in this industry guide. The DOE standard occasionally goes beyond the minimum general industry standards established by OSHA and ANSI and also delineates the more stringent requirements necessary to accomplish the extremely complex, diversified, critical, and oftentimes hazardous hoisting and rigging work found within the DOE complex. The following items, which are not covered in detail in the OSHA standards, may be good resources for employers working with cranes:

1. Management responsibility and accountability
2. Operator/inspector training and qualification requirements
3. Definition of critical lifts and the additional requirements for making them
4. The need and responsibilities of a person-in-charge for critical lifts
5. The need and responsibilities of a designated leader for ordinary lifts
6. The definition and special requirements for preengineered production lifts
7. Special requirements for the testing, inspection and maintenance of hoisting equipment in hostile environments
8. Nondestructive testing/nondestructive examination requirements for such items as hooks, welds, and spreader bars
9. Special requirements for inspection and load-testing of hoisting and rigging equipment/accessories
10. Hook latch requirements for cranes, slings and rigging accessories
11. Design standards for such equipment as cranes, forklifts and hooks
12. Operating practices for hoisting and rigging operations
13. Rigging information and load tables
14. Good and bad rigging practices

آریا ایمن آوات

DOE-STD-1090-2001 Table of Contents

Part 1

Summary of Changes
Table of Contents
History and Background
Acknowledgment
Introduction
Chapter 1 - Terminology and Definitions

Part 2

Chapter 2 - Critical Lifts
Chapter 3 - Preengineered Production Lifts
Chapter 4 - Lifting Personnel

Part 3

Chapter 5 - Hostile Environment
Chapter 6 - Personnel Qualification and Training
Chapter 7 - Overhead and Gantry Cranes

Part 4

Chapter 8 - Hoists
Chapter 9 - Mobile Cranes

Part 5

Chapter 10 - Forklifts Trucks

Part 6

Chapter 11 - Wire Rope and Slings

Part 7

Chapter 12 - Rigging Accessories
Chapter 13 - Load Hooks

Part 8

Chapter 14 - Below-The-Hook Lifting Devices

Part 9

Chapter 15 - Construction Hoisting and Rigging Equipment Requirements

Part 10

Chapter 16 - Miscellaneous Lifting Devices
Chapter 17 - References
Appendix A - Procurement Guidelines
Concluding Material

آریا ایمن آوات

CHAPTER 1

TERMINOLOGY AND DEFINITIONS

The following are specialized terms commonly used when discussing hoisting and rigging operations. Many may not be used in this standard but are included for general information. The terms are arranged in alphabetical order. Illustrations are included for clarity.

ABRASION: Surface wear.

ACCELERATION STRESS: Additional stress imposed due to increasing load velocity.

ALTERNATE LAY: Lay of wire rope in which the strands are alternately regular and lang lay.

ANSI: American National Standards Institute.

APPOINTED: Assigned specific responsibilities by the employer or the employer's representative.

AREA, METALLIC: Sum of the cross-sectional areas of individual wires in a wire rope or strand.

ATTACHMENT: A device other than conventional forks or load backrest extension, mounted permanently or removably on the elevating mechanism of a truck for handling the load. Popular types are fork extension clamps, rotating devices, side shifters, load stabilizers, rams, and booms.

AUTHORIZED: Assigned by a duly constituted administrative or regulatory authority.

AUXILIARY HOIST: Supplemental hoisting unit of lighter capacity and usually higher speed than the main hoist.

BACK STAY: Guy used to support a boom or mast or that section of a main cable, as on a suspension bridge, or cableway, and the like, leading from the tower to the anchorage.

BAIL: A U-shaped member of a bucket, socket, or other fitting.

BASKET OR SOCKET: The conical portion of a socket into which a splayed rope end is inserted and secured with zinc.

BATTERY-ELECTRIC TRUCK: An electric truck in which the power source is a storage battery.

BECKET LOOP: A loop of small rope or a strand of rope fastened to the end of a large wire rope to facilitate installation.

BENDING STRESS: Stress on wires of a wire rope imposed by bending. This stress need not be added to direct load stresses. When sheaves and drums are of suitable size, bending stress does not affect the normal life of the wire rope.

BIRDCAGE: A colloquialism describing the appearance of a wire rope that is forced into compression. The outer strands form a "cage" and at times displace the core.

BIRDCAGING: The twisting of fiber or wire rope in an isolated area in the opposite direction of the rope lay, causing it to take on the appearance of a birdcage.

BOOM (CRANE): A member hinged to the rotating superstructure and used for supporting the hoisting tackle.

BOOM LINE: A wire rope for supporting or operating the boom on derricks, cranes, draglines, shovels, and the like.

BRAKE: A device used for slowing or stopping motion by friction or electromagnetic means.

BRAKE, DRAG: A brake that provides stopping force without external control.

BRAKE, HOLDING: A brake that sets automatically and that prevents motion when power is off.

BRAKE, PARKING: A device to prevent the movement of a stationary vehicle.

BRAKING, COUNTER TORQUE: A method of stopping motion in which the power to the motor is reversed to develop torque in the opposite direction.

BRAKING, DYNAMIC: A method of controlling crane motor speeds when in the overhauling condition to provide a retarding force.

BRAKING, MECHANICAL: A method of slowing motion by friction.

BRAKING, REGENERATIVE: A form of dynamic braking in which the electrical energy generated is fed back into the power system.

BREAKING STRENGTH: The measured load required to break a wire rope or chain.

BRIDGE: The part of a crane, consisting of girders, walkways, railings, trucks, and drive mechanisms, that carries the trolley or trolleys.

BRIDGE TRAVEL: Horizontal travel of the crane parallel with runway rails.

BRIDLE SLING: A sling composed of multiple legs (branches), the top ends of which terminate in a fitting that latches onto the lifting hook.

BULL RING: The main large ring of a sling to which sling legs are attached.

BUMPER (BUFFER): An energy-absorbing device for reducing impact when a moving overhead crane or trolley reaches the end of its permitted travel, or when two moving cranes or trolleys come into contact.

CAB: The operator's compartment.

CABLE: A term loosely applied to wire ropes, wire strands, manila ropes, and electrical conductors.

CABLE-LAID WIRE ROPE: A type of wire rope consisting of several independent wire ropes laid into a single wire rope.

CABLE CROWD ROPE: A wire rope used to force the bucket of a power shovel into the material being handled.

CANTILEVER TRUCK: A self-loading counterbalanced or noncounterbalanced truck equipped with cantilever load-engaging means, such as forks (see Figure 10-3).

CARRIAGE: A support structure for forks or attachments, generally roller-mounted, traveling vertically within the mast of a cantilever truck.

CENTER: A single wire or fiber in the center of a strand around which the wires are laid.

CENTER CONTROL: The position near the center of a truck cab from which the operator controls movement of the truck.

CHOKER ROPE: A short wire-rope sling used to form a slip noose around the object to be moved or lifted (see Figure 1-1).

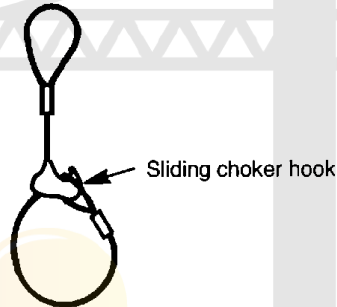

Figure 1-1. Choker rope.

CIRCUMFERENCE: Measured perimeter of a circle circumscribing the wires of a strand or the strands of a wire rope.

CLAMP, STRAND: A fitting used to form a loop at the end of a length of strand; consists of two grooved plates and bolts.

CLEARANCE: The distance by which one object clears another, or the clear space between them.

CLEVIS: A U-shaped fitting with pins.

CLIP: A fitting used to clamp two parts of wire rope.

CLOSED SOCKET: A wire-rope fitting consisting of an integral becket and bail.

CLOSING LINE: Wire rope that closes a clamshell or orange-peel bucket and then operates as a hoisting rope.

COIL: Circular bundle of wire rope not packed on a reel.

COLLECTOR: Contacting device mounted on a bridge or trolley and used to collect current from the conductor system.

COME-ALONG: A portable, hand-operated device consisting of a housing, a length of chain or wire rope, two hooks, and a ratcheting lever, that is used for miscellaneous pulling.

CONDUCTOR: Wire, angles, bars, tees, or special sections mounted to transmit current to the collectors.

CONICAL DRUM: Grooved hoisting drum of varying diameter.

CONSTRUCTION (WIRE ROPE): Refers to the design of wire rope, including number of strands, number of wires per strand, and arrangement of wires in each strand.

CONTINUOUS BEND: Reeving of wire rope over sheaves and drums so that it bends in one direction (as opposed to reverse bend).

CONTROLLER: An operator's device for regulating the power delivered to a motor or other equipment.

CONTROLLER, SPRING RETURN: A controller that, when released, will return automatically to a neutral position.

CORE: The center member of a wire rope around which the strands are laid. It may be fiber, a wire strand, or an independent wire rope.

CORING LINE: Wire rope used to operate the coring tool for taking core samples during the drilling of a well.

CORROSION: Chemical decomposition by exposure to moisture, acids, alkalies, or other destructive agents.

CORRUGATED: A term used to describe the grooves of a sheave or drum when worn so as to show the impression of a wire rope.

COUNTERBALANCED TRUCK: A truck equipped with load-engaging means wherein, during normal transporting, all the load is external to the polygon formed by the wheel contacts (see Figure 10-3).

COVER WIRES: The outer layer of wires.

CRANE: A machine used for lifting and lowering a load vertically and moving it horizontally and that has a hoisting mechanism as an integral part of it.

CRANES, TYPES OF:

Automatic Crane: A crane that, when activated, operates through a preset cycle or cycles.

Cab-Operated Crane: A crane controlled by an operator in a cab located on the bridge or trolley.

Cantilever Gantry Crane: A gantry or semigantry crane in which the bridge girders or trusses extend transversely beyond the crane runway on one or both sides.

Floor-Operated Crane: A crane whose operation is controlled by use of a pendant in the hands of an operator on the floor or on an independent platform.

Gantry Crane: A crane similar to an overhead crane, except that the bridge for carrying the trolley or trolleys is rigidly supported on two or more legs running on fixed rails or other runway.

Jib Crane: A fixed crane with a vertical rotating member supported at the bottom (also at the top in some types) from which an arm extends to carry the hoist trolley. Jib cranes are most commonly mounted on a vertical column, supplied as part of the jib crane, or on existing structural members (e.g., a wall-mounted jib crane).

Mobile Crane: For the purposes of this chapter, mobile cranes are defined as wheel-mounted cranes, truck cranes, and crawler cranes.

o A **wheel-mounted** crane consists of a rotating structure with power plant, operating machinery, and boom, mounted on a base or platform equipped with axles and rubber-tired wheels for travel. The base is usually propelled by an engine in the superstructure, but it may be equipped with a separate engine controlled from the superstructure (see Figures 15-1, 15-3, 15-5, 15-6, 15-7, 15-9, and 15-10).

- o A **truck-mounted crane** consists of a rotating superstructure with power plant that operates machinery and boom, mounted on an automotive truck equipped with a power plant for travel. Commercial truck-mounted cranes are included in this category (see Figures 15-3, 15-7, 15-9, and 15-10).
- o A **crawler crane** consists of a rotating superstructure with power plant, operating machinery and boom, mounted on a base equipped with crawler treads for travel (see Figures 15-2 and 15-8).

Overhead Traveling Crane: A crane with a movable bridge carrying a movable or fixed hoisting mechanism and traveling on an overhead fixed-runway structure.

Power-Operated Crane: A crane whose mechanism is driven by electricity, air, hydraulics, or internal combustion.

Pulpit-Operated Crane: A crane operated from a fixed operator station that is not attached to the crane.

Remote-Operated Crane: A crane controlled by an operator not in a pulpit or a cab attached to the crane, by any method other than pendant or rope control (e.g., radio-controlled crane).

Semigantry Crane: A gantry crane with one end of the bridge rigidly supported on one or more legs that run on a fixed rail or runway, the other end of the bridge being supported by a truck running on an elevated rail or runway.

Shop Crane: A Portable Automotive Lifting Device (PALD), self contained hydraulic and pneumatic-hydraulic crane characterized by a pair of laterally spaced legs, an upright mast, a pivoting boom with a boom extension and hook, and a hydraulic unit. The hydraulic unit moves the boom up and down at a pivot point for the purpose of raising, removing, transporting in the lowered position, and replacing automotive engines, transmissions and other components. Shop cranes have a capacity of 4 tons (8000 pounds) or less.

Wall-Mounted Crane: A crane having a jib, with or without a trolley, supported from a side wall or line of columns of a building. It is a traveling-type crane and operates on a runway attached to the side wall or line of columns.

Wall-Mounted Jib Crane: See Cranes, Types Of, Jib Crane.

CRITICAL DIAMETER: Diameter of the smallest bend for a given wire rope that permits the wires and strands to adjust themselves by relative movement while remaining in their normal positions.

CYLINDRICAL DRUM: Hoisting drum of uniform diameter.

DECELERATION STRESS: Additional stress imposed on a wire rope due to decreasing the load velocity.

DEFLECTION:

- o Sag of a rope in a span, usually measured at midspan as the depth from a chord joining the tops of the two supports.
- o Any deviation from a straight line.

DESIGN FACTOR: Ratio of ultimate strength to the design working stress.

DESIGNATED: Selected or assigned by the employer or the employer's representative as being qualified to perform specific duties.

DESIGNATED LEADER: "An individual assigned responsibility for hoisting and rigging activities requiring more than one person".

DIAMETER: Distance measured across the center of a circle circumscribing the wires of a strand or the strands of a wire rope.

DIESEL-ELECTRIC TRUCK: An electric truck in which the power source is a generator driven by a diesel engine.

DOCKBOARD: A portable or fixed device for spanning the gap or compensating for the difference in level between loading platforms and carriers.

DOG-LEG: Permanent short bend or kink in a wire rope caused by improper use.

DOE-STD-1090-2001

DRAGLINE: Wire rope used to pull an excavating or drag bucket.

DRIVE: Motor, coupling, brake and gear case, or gear cases used to propel bridge, trolley, or hoist.

DRIVE GIRDER: A girder on which is mounted the bridge drive, cross shaft, walk, railing, and operator's cab.

DRUM: A cylindrical-flanged barrel of uniform (cylindrical drum) or tapering (conical drum) diameter on which a wire rope is wound for operation or storage. It may be smooth or grooved.

ELASTIC LIMIT: Limit of stress beyond which a permanent deformation takes place within the material. This limit is approximately 55–65 percent of breaking strength of steel-wire ropes.

ELECTRIC TRUCK: A truck in which the principal energy is transmitted from power source to motor(s) in the form of electricity.

END CONTROL: An operator-control position that is located at the end opposite the load end of the truck.

EQUALIZER: A device used to compensate for unequal length or stretch of a hoist rope.

EQUALIZING SLINGS: Slings composed of wire rope and equalizing fittings.

EQUALIZING THIMBLES: A special type of fitting used as a component part of some wire-rope slings.

EYE OR EYE SPLICE: A loop with or without a thimble formed in the end of a wire rope.

FAIL-SAFE: A provision designed to automatically stop or safely control any motion in which a malfunction could occur.

FATIGUE: The tendency of a material to break under repeated stress.

FIBER CENTERS: Cords or rope made of vegetable fiber used in the center of a strand.

FIBER CORES: Cords or rope made of vegetable fiber used in the core of a wire rope.

FIRST POINT: The first setting on the operator's controller that starts crane motion (slowly) in each direction.

FITTING: Any accessory used as an attachment for wire rope.

FLAG: Mark or marker on a rope to designate position of load.

FLAT ROPE: Wire rope made of parallel alternating right-lay and left-lay ropes sewn together by relatively soft wires.

FLATTENED STRAND ROPE: A wire rope with either oval or triangular strands that present a flattened rope surface.

FLEET ANGLE: Angle between the position of a rope at the extreme end wrap on a drum and a line drawn perpendicular to the axis of the drum through the center of the nearest fixed sheave.

FORKS: Horizontal tine-like projections, normally suspended from the carriage, used to engage and support loads.

FORK HEIGHT: The vertical distance from the floor to the load-carrying surface adjacent to the heel of the forks with the mast vertical, and in the case of reach trucks, with the forks extended.

FORKLIFT TRUCK: A high-lift self-loading truck equipped with load carriage and forks for transporting and tiering loads (see Figure 10-3).

GALVANIZE: To coat with zinc to protect against corrosion.

GALVANIZED ROPE: Rope made of galvanized wire.

GALVANIZED STRAND: Strand made of galvanized wire.

GALVANIZED WIRE: Wire coated with zinc.

GAS-ELECTRIC TRUCK: An electric truck in which the power source is a generator driven by an LP-gas or gasoline engine.

GROMMET: A seven-strand wire-rope sling made from one continuous length of strand or an endless synthetic-web sling.

GROOVED DRUM: Drum with grooved outer surface to accommodate and guide a rope.

GROOVES: Depressions in the outer surface of a sheave or drum for positioning and supporting a rope.

GUY LINE: Strand or rope, usually galvanized, for holding a structure in position.

HANDLING FIXTURE: A cradle, structure, shipping fixture, or container designed specifically to facilitate supporting, lifting, or handling a component during fabrication, loading, shipping, storage, or installation.

HIGH-LIFT TRUCK: A self-loading truck equipped with an elevating mechanism designed to permit tiering. Popular types are high-lift platform trucks (see Figure 10-3).

HIGH-LIFT PLATFORM TRUCK: A self-loading truck equipped with an elevating mechanism intended primarily for transporting and tiering loaded skid platforms (see Figure 10-3).

HOIST: A device that applies a force for lifting or lowering.

HOIST, LEVER OPERATED: A lever-operated manual device used to lift, lower, or pull a load and to apply or release tension.

HOLDING LINE: Wire rope on a clamshell or orange-peel bucket that holds the bucket while the closing line is released to dump the load.

HOOK LOAD: The total live weight supported by the hook of a crane, derrick, or other hoisting equipment, including the load, slings, spreader bars, and other tackle not part of the load but supported by the hook and required for the handling of the load.

IDLER: Sheave or roller used to guide or support a rope.

INDEPENDENT WIRE-ROPE CORE: Wire rope used as the core of a larger rope.

INNER WIRES: All wires of a strand except surface or cover wires.

INTERNAL-COMBUSTION ENGINE

TRUCK: A truck in which the power source is a gas or diesel engine.

INTERNALLY LUBRICATED: Wire rope or strand having all wires coated with lubricant.

KINK: Permanent distortion of wires and strands resulting from sharp bends.

LAGGING: External wood covering on a reel of rope or a strand.

LANG-LAY ROPE: Wire rope in which the wires in the strands and the strands in the rope are laid in the same direction.

LAY LENGTH: The lengthwise distance on a wire rope in which a strand makes one complete turn around the rope's axis (see Figure 1-2).



Figure 1-2. Rope Lay

Left Lay:

- o **Strand:** Strand in which the cover wires are laid in a helix having a left-hand pitch, similar to a left-hand screw.
- o **Rope:** Rope in which the strands are laid in a helix having a left-hand pitch, similar to a left-hand screw.

Right Lay:

- o **Strand:** Strand in which the cover wires are laid in a helix having a right-hand pitch, similar to a right-hand screw.
- o **Rope:** Rope in which the strands are laid in a helix having a right-hand pitch, similar to a right-hand screw.

LIFT:

- o Maximum safe vertical distance through which a hook can travel.
- o The hoisting of a load.

LIFT, CRITICAL: A lift for which the application of requirements applicable to ordinary lifts would not adequately eliminate or control the likelihood or severity of the following:

- o personnel injury or significant adverse health impact (onsite or offsite).
- o significant release of radioactivity or other hazardous material or other undesirable conditions.
- o undetectable damage that would jeopardize future operations or the safety of a facility.
- o damage that would result in delay to schedule or other significant program impact such as loss of vital data.

LIFT, ORDINARY: Any lift not designated as a critical lift or a preengineered production lift.

LIFT, PREENGINEERED PRODUCTION: Repetitive, production-type lifting operation, independent of the nature of the load to be lifted, in which the probability of dropping, upset, or collision is reduced to a level acceptable to the responsible manager by preliminary engineering evaluation, specialized lifting fixtures, detailed procedures, operation-specific training, and independent review and approval of the entire process.

LINE: A rope used for supporting and controlling a suspended load.

LOAD: The total weight superimposed on the load block or hook.

LOAD BLOCK: The assembly of hook or shackle, swivel, bearing, sheaves, pins, and frame suspended by the hoisting ropes.

LOAD-BACKREST EXTENSION: A device extending vertically from the fork carriage frame.

LOAD-BEARING PARTS: Any part of a material-handling device in which the induced stress is influenced by the hook load. A *primary* load-bearing part is a part the failure of which could result in dropping, upset, or uncontrolled motion of the load. Load-bearing parts which, if failed, would result in no more than stoppage of the equipment without causing dropping, upset, or loss of control of the load are not considered to be primary load-bearing parts.

LOAD CENTER (FORKLIFTS): The horizontal longitudinal distance from the intersection of the horizontal load-carrying surfaces and vertical load-engaging faces of the forks (or equivalent load-positioning structure) to the center of gravity of the load.

LOW-LIFT TRUCK: A self-loading truck equipped with an elevating mechanism designed to raise the load only sufficiently to permit horizontal movement (see Figure 10-3).

MAGNET: An electromagnetic device carried on a crane hook and used to pick up loads.

MAIN HOIST: The hoist mechanism provided for lifting the maximum-rated load.

MAN TROLLEY: A trolley having an operator's cab attached to it.

MARLINE SPIKE: Tapered steel pin used in splicing wire rope.

MESSENGER STRAND: Galvanized strand or bronze strand used to support telephone and electrical cables.

MODULUS OF ELASTICITY: Mathematical quantity giving the ratio, within the elastic limit, between a definite range of unit stress on a wire rope and the corresponding elongation.

MOUSING: A method of bridging the throat opening of a hook to prevent the release of load lines and slings, under service or slack conditions, by wrapping with soft wire, rope, heavy tape, or similar materials.

NARROW-AISLE TRUCK: A self-loading truck intended primarily for right-angle stacking in aisles narrower than those normally required by counterbalanced trucks of the same capacity (see Figure 10-3).

NONDESTRUCTIVE EXAMINATION

(NDE): The development and application of technical methods to examine materials or components, in ways that do not impair future usefulness and serviceability, in order to detect, locate, measure, and evaluate discontinuities, defects, and other imperfections; to assess integrity, properties, and composition; and to measure geometrical characteristics.

NONDESTRUCTIVE TESTING (NDT): See NONDESTRUCTIVE EXAMINATION.

NONROTATING WIRE ROPE: See Rotation-Resistant Wire Rope.

OPEN SOCKET: A wire-rope fitting consisting of a basket and two ears with a pin.

ORDER-PICKER TRUCK, HIGH-LIFT: A truck, controllable by an operator stationed on a platform, which is movable, has a load-engaging means, and is intended for (manual) stock selection. The truck may be capable of self-loading and/or tiering (see Figure 10-3).

OVERHEAD GUARD: A framework fitted to a truck over the head of a riding operator.

PALLET TRUCK: A self-loading, non-motorized or motorized low-lift truck equipped with wheeled forks of dimensions sized to go between the top and bottom boards of a double-faced pallet, the wheels fitting into spaces between the bottom boards, so as to raise the pallet off the floor for transporting (see Figure 10-3).

PEENING: Permanent distortion of outside wire in a rope caused by pounding.

PERSON-IN-CHARGE (PIC): The manager or other responsible person (other than the equipment operator) known to be qualified and appointed to be responsible for the safe handling of critical loads.

POWERED INDUSTRIAL TRUCK: A mobile, power-driven vehicle used to carry, push, pull, lift, stack, or tier material.

PRECISION LOAD POSITIONING

DEVICES: A rigging accessory designed specifically to precisely raise and lower a load through a limited range of lifting/lowering motion (stroke). Standards units typically have 12 in. (30 cm) stroke and can position a load within 0.001 in. (0.025 mm). These devices commonly include a built-in load scale and in such cases may also serve as a load-indicating device.

PREFORMED WIRE ROPE: Wire rope in which the strands are permanently shaped, before being fabricated into the rope, to the helical form they assume in the wire rope.

PREFORMED STRAND: Strand in which the wires are permanently shaped, before being fabricated into the strands, to the helical form they assume in the strand.

PRESTRESSING: Stressing a wire rope or strand before use under such a tension and for such a time that stretch that would otherwise occur once the load is picked up is largely nonexistent.

PROOF TEST: A nondestructive tension test performed to verify construction and workmanship of slings or rigging accessories.

PUBLIC CARRIER: A for-hire company engaged in the public transportation of goods.

QUALIFIED: A person who, by possession of a recognized degree, certificate, or professional standing, or who, by extensive knowledge, training, and experience, has successfully demonstrated an ability and competence to solve or resolve problems relating to the subject matter and work.

QUALIFIED ENGINEER/QUALIFIED ENGINEERING ORGANIZATION: An engineer or engineering organization whose competence in evaluation of the type of equipment in question has been demonstrated to the satisfaction of the responsible manager.

QUALIFIED INSPECTOR: One whose competence is recognized by the responsible manager and whose qualification to perform specific inspection activities has been determined, verified, and attested to in writing.

QUALIFIED OPERATOR: One who has had appropriate and approved training, including satisfactory completion of both written and operational tests to demonstrate knowledge, competence, and skill, in the safe operation of the equipment to be used.

QUALIFIED RIGGER: One whose competence in this skill has been demonstrated by experience satisfactory to the appointed person.

NOTE: The term “rigger” or “qualified rigger” in this standard refers to the function performed, and in no way relates to the worker's classification in any union or bargaining unit.

RATED CAPACITY: The maximum hook load that a piece of hoisting equipment is designed to carry; also the maximum load that an industrial truck or a sling, hook, shackle, or other rigging tackle is designed to carry.

NOTE: At the option of the user, a rated capacity can be assigned that is less than the design-rated capacity.

REACH TRUCK: A self-loading truck, generally high-lift, having load-engaging means mounted so it can be extended forward under control to permit a load to be picked up and deposited in the extended position and transported in the retracted position (see Figure 10-3).

REEL: The flanged spool on which wire rope or strand is wound for storage or shipment.

REEVING: A system in which a rope travels around drums or sheaves.

REGULAR-LAY ROPE: Wire rope in which the wires in the strands and the strands in the rope are laid in opposite directions.

REVERSE BEND: Reeving of a wire rope over sheaves and drums so that it bends in opposite directions.

RIDER TRUCK: A truck that is designed to be controlled by a riding operator.

RIGGING: The hardware or equipment used to safely attach a load to a lifting device. The art or process of safely attaching a load to a hook by means of adequately rated and properly applied slings and related hardware.

ROLLERS: Relatively small-diameter cylinders or wide-faced sheaves used for supporting or guiding ropes.

ROTATION-RESISTANT WIRE ROPE: Wire rope consisting of a left-lay, lang-lay inner rope covered by right-lay, regular-lay outer strands.

RUNNING SHEAVE: A sheave that rotates as the load block is raised or lowered.

RUNWAY: Assembly of rails, girders, brackets, and framework on which a crane operates.

SAFE WORKING LOAD: Load that a rope may carry economically and safely.

SEALE: A strand construction having one size of cover wires with the same number of one size of wires in the inner layer and each layer having the same length and direction of lay. Most common construction is one center wire, nine inner wires, and nine cover wires.

SEIZE: To securely bind the end of a wire rope or strand with seizing wire or strand.

SEIZING STRAND: Small strand, usually of seven wires, made of soft-annealed-iron wire.

SEIZING WIRE: A soft-annealed-iron wire.

SELF-LOADER: A truck with tires that can fit between the top and bottom boards of a double-faced pallet.

SERVE: To cover the surface of a wire rope or strand with a wrapping of wire.

SHACKLE: A type of clevis normally used for lifting (see Figure 1-3).

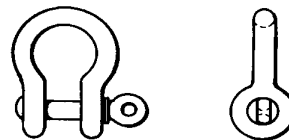

Figure 1-3. Shackle.

SHALL: A word indicating that an action is mandatory.

SHEAVE: A grooved wheel or pulley used with a rope to change direction and point of application of a pulling force.

SHEAVE, NONRUNNING (EQUALIZER): A sheave used to equalize tension in opposite parts of a rope, called nonrunning because of its slight movement.

SHEAVE, RUNNING: A sheave that rotates as the load block is lifted or lowered.

SHOULD: A word indicating a recommended action, the advisability of which depends on the facts in each situation.

SIDE LOADER: A self-loading truck, generally high-lift, having load-engaging means mounted in such a manner that it can be extended laterally under control to permit a load to be picked up and deposited in the extended position and transported in the retracted position (see Figure 10-3).

SIDE PULL: That portion of a hoist pull acting horizontally when the hoist lines are not operated vertically.

SLINGS: Wire ropes, chains, synthetic web, and metal mesh made into forms, with or without fittings, for handling loads.

SLINGS, BRAIDED: Very flexible slings composed of several individual wire ropes braided together.

SMOOTH-FACED DRUM: Drum with a plain, not grooved, face.

SPAN: The horizontal, center-to-center distance of runway rails.

SPIRAL GROOVE: Groove that follows the path of a helix around a drum, similar to the thread of a screw.

SPLICING: Interweaving of two ends of rope to make a continuous or endless length without appreciably increasing the diameter. Also refers to making a loop or eye in the end of a rope by tucking the ends of the strands.

Splice, Hand Tucked: A loop or eye formed in the end of a rope by tucking the end of the strands back into the main body of the rope in a prescribed manner.

Splice, Mechanical: A loop or eye formed in the end of a wire rope by pressing or swaging one or more metal sleeve over the wire rope junction.

STAINLESS-STEEL ROPE: Wire rope made of chrome-nickel steel wires having great resistance to corrosion.

STEEL-CLAD ROPE: Rope with individual strands spirally wrapped with flat steel wire.

STRAND: An arrangement of wires helically laid about an axis or another wire or fiber center to produce a symmetrical section.

SUSPECT/COUNTERFEIT ITEMS (S/CI): A suspect item is one in which visual inspection, testing, or other means indicate that it may not conform to established Government or industry-accepted specifications or national consensus standards. A counterfeit item is a suspect item that has been copied or substituted without legal right or authority to do so or one whose material, performance, or characteristics are knowingly misrepresented by the vendor, supplier, distributor, or manufacturer (see Figure 1-5).

NOTE: (refer to DOE G 440.1-6 "Implementation Guide For Use With Suspect/Counterfeit Requirements" of DOE O 440.1, Worker Protection Management).

SWAGED FITTINGS: Fittings in which wire rope is inserted and attached by a cold-forming method.

SWITCH, ELECTRIC: A device for making, breaking, or changing the connections in an electrical circuit.

SWITCH, EMERGENCY STOP: A manually or automatically operated electric switch to cut off electric power independently of the regular operating controls.

SWITCH, LIMIT: A switch that is operated by some part or motion of a power-driven machine or equipment to alter the electrical circuit associated with the machine or equipment.

SWITCH, MAIN: A switch controlling the entire power supply to a crane or other equipment, often called the disconnect switch.

TAG LINE: A rope used to prevent rotation of a load.

TAPERING AND WELDING: Reducing the diameter of the end of a wire rope and welding it to facilitate reeving.

THIMBLE: Grooved metal fitting to protect the eye of a wire rope (see Figure 1-4).

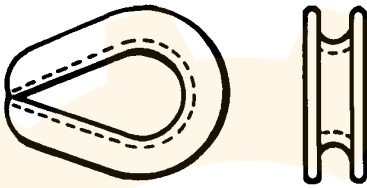

Figure 1-4. Thimble.

TIERING: The process of placing one load on or above another.

TINNED WIRE: Wire coated with tin.

TROLLEY: A unit consisting of frame, trucks, trolley drive, and hoisting mechanism moving on the bridge rails in a direction at right angles to the crane runway.

TROLLEY GIRTS: Structural members that are supported on the trolley trucks and that contain the upper sheave assemblies.

TROLLEY TRAVEL: Horizontal travel of a trolley at right angles to runway rails.

TROLLEY TRUCK: An assembly consisting of wheels, bearings, axles, and structural-supporting hoist mechanism and load girts.

TRUCK, POWERED INDUSTRIAL: A mobile, power-propelled truck used to carry, push, pull, lift, stack, or tier material (see Figure 10-3).

TURNBUCKLE: A device attached to wire rope for making limited adjustments in length. It consists of a barrel and right- and left-hand threaded bolts.

TWO-BLOCKING: The act of continued hoisting in which the load-block and head-block assemblies are brought into physical contact, thereby preventing further movement of the load block and creating shock loads to the rope and reeving system.

VERIFICATION: A procedure in which a design, calculation, drawing, procedure, instruction, report, or document is checked and signed by one or more parties. The one or more persons designated to sign verify, based on personal observation, certified records, or direct reports, that a specific action has been performed in accordance with specified requirements.

WEDGE SOCKET: Wire-rope fitting in which the rope end is secured by a wedge.

WHEEL BASE: Distance between centers of outermost wheels for bridge and trolley trucks.

WHEEL LOAD: The load on any wheel with the trolley and lifted load (rated load) positioned on the bridge to give maximum-loading conditions.

WIRE ROPE: Wire strands laid helically around an axis or a core.

WIRE (ROUND): Single continuous length of metal, cold drawn from a rod.

WIRE (SHAPED): A single continuous length of metal either cold drawn or cold rolled from a rod.

DOE HEADMARK LIST

ANY BOLT ON THIS LIST SHOULD BE TREATED AS DEFECTIVE WITHOUT FURTHER TESTING

ALL GRADE 5 AND GRADE 8 FASTENERS OF FOREIGN ORIGIN WHICH DO NOT BEAR ANY MANUFACTURE'S HEADMARKS:



GRADE 5















GRADE 8

GRADE 5 FASTENERS WITH THE FOLLOWING HEADMARKS:

<u>MARK</u>	<u>MANUFACTURER</u>	<u>MARK</u>	<u>MANUFACTURER</u>
 J	Jinn Her (TW)	 KS	Kosaka Kogyo (JP)



GRADE 8 FASTENERS WITH THE FOLLOWING HEADMARKS:

<u>MARK</u>	<u>MANUFACTURER</u>	<u>MARK</u>	<u>MANUFACTURER</u>
 A	Asahi Mfg (JP)	 KS	Kosaka Kogyo (JP)
 E	Dalai (JP)	 M	Minamida Sleybo (JP)
 FM	Fastener Co. of Japan (JP)	 MS	Minato Kogyo (JP)
 H	Hinamoto Metal (JP)	 NF	Nippon Fasteners (JP)
 J	Jinn Her (TW)	 RT	Takai Lid (JP)
 KY	Kyoel Mfg (JP)	 UNY	Unytite (JP)
 Hollow Triangle	Intasco (CA, TW, JP, YU) (Greater than 1/2 inch diameter)		

GRADE 8.2 FASTENERS WITH THE FOLLOWING HEADMARKS:

<u>MARK</u>	<u>MANUFACTURER</u>
 KS	Kosaka Kogyo (JP)

GRADE A325 FASTENERS (BENNETT DENVER TARGET ONLY) WITH THE FOLLOWING HEADMARKS:

	<u>MARK</u>	<u>MANUFACTURER</u>
Type 1	 A325KS	A325KS Kosaka Kogyo (JP)
Type 2	 A325KS	
Type 3	 A325KS	

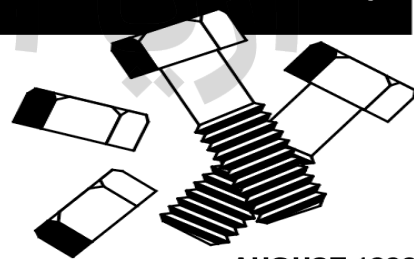

KEY: CA - CANADA JP - JAPAN TW - TAIWAN YU - YUGOSLAVIA

AUGUST 1992

GF00 0209

Figure. 1-5.

CHAPTER 2 CRITICAL LIFTS

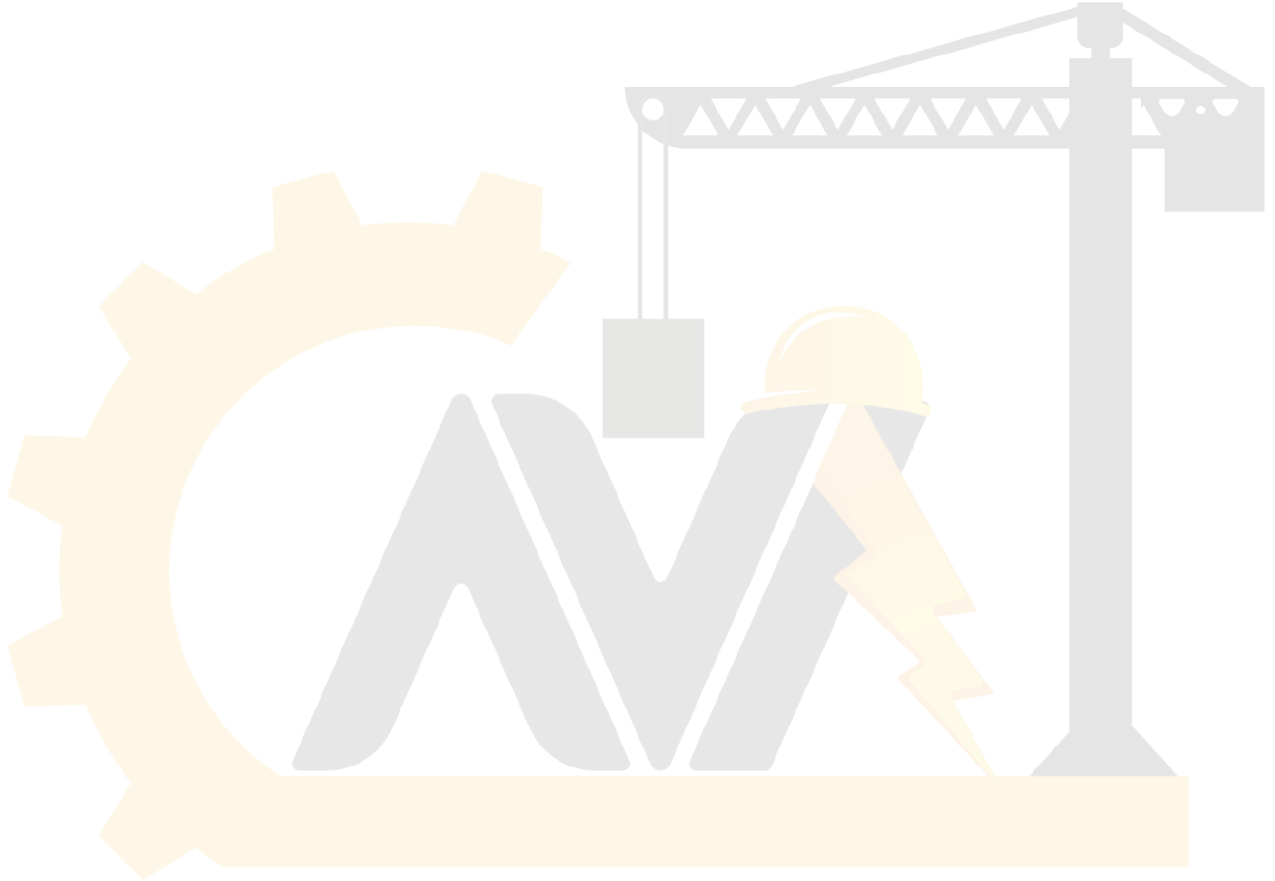

آریا ایمن آوات

2.2 CRITICAL-LIFT REQUIREMENTS

- a. Ensure that the requirements are met for ordinary lifts specified in each section of this standard for each particular equipment category.
- b. The operating organization shall appoint a Person-In-Charge (PIC) for the entire operation. This person shall meet the definitions of appointed, designated, and qualified as described in Chapter 1, "Terminology and Definitions," and shall be present at the lift site during the entire lifting operation.
- c. The PIC shall ensure that a pre-job plan or procedure is prepared that defines the operation and includes the following:
1. Identification of the items to be moved, the weight, dimensions, and center of gravity of the load, and any hazardous or toxic materials that are present
 2. Identification of operating equipment to be used by type and rated capacity
 3. Rigging sketches that include (as applicable):
 - i. Identification and rated capacity of slings, lifting bars, rigging accessories, and below-the-hook lifting devices.
 - ii. Load-indicating devices.
 - iii. Load vectors.
 - iv. Lifting points.
 - v. Sling angles.
 - vi. Boom and swing angles.
 - vii. Methods of attachment.
 - viii. Crane orientations.
 - ix. Other factors affecting equipment capacity.
 4. Operating procedures and special instructions to operators including rigging precautions and safety measures to be followed as applicable.
 - d. Experienced operators who have been trained and qualified to operate the specific equipment to be used shall be assigned to make the lift.
 - e. Only designated, qualified signalers shall give signals to the operator. However, the operator shall obey a STOP signal at all times, no matter who gives the signal.
 - f. The procedure and rigging sketches shall be reviewed and approved by the responsible manager (or designee) and the responsible oversight organization (such as safety, quality assurance, or quality control) before the lift is made.
 - g. A pre-lift meeting involving participating personnel shall be conducted prior to making a critical lift. The critical lift plan/procedure shall be reviewed and questions shall be resolved.
 - h. If required by the critical lift procedure, a practice lift shall be done before the critical lift. Conditions for a practice lift should closely simulate actual conditions involving: weight, rigging selection and configuration, load movement path, and other relevant factors. Practice lifts should be done by the same crew, using the same lifting equipment.

CHAPTER 4

LIFTING PERSONNEL

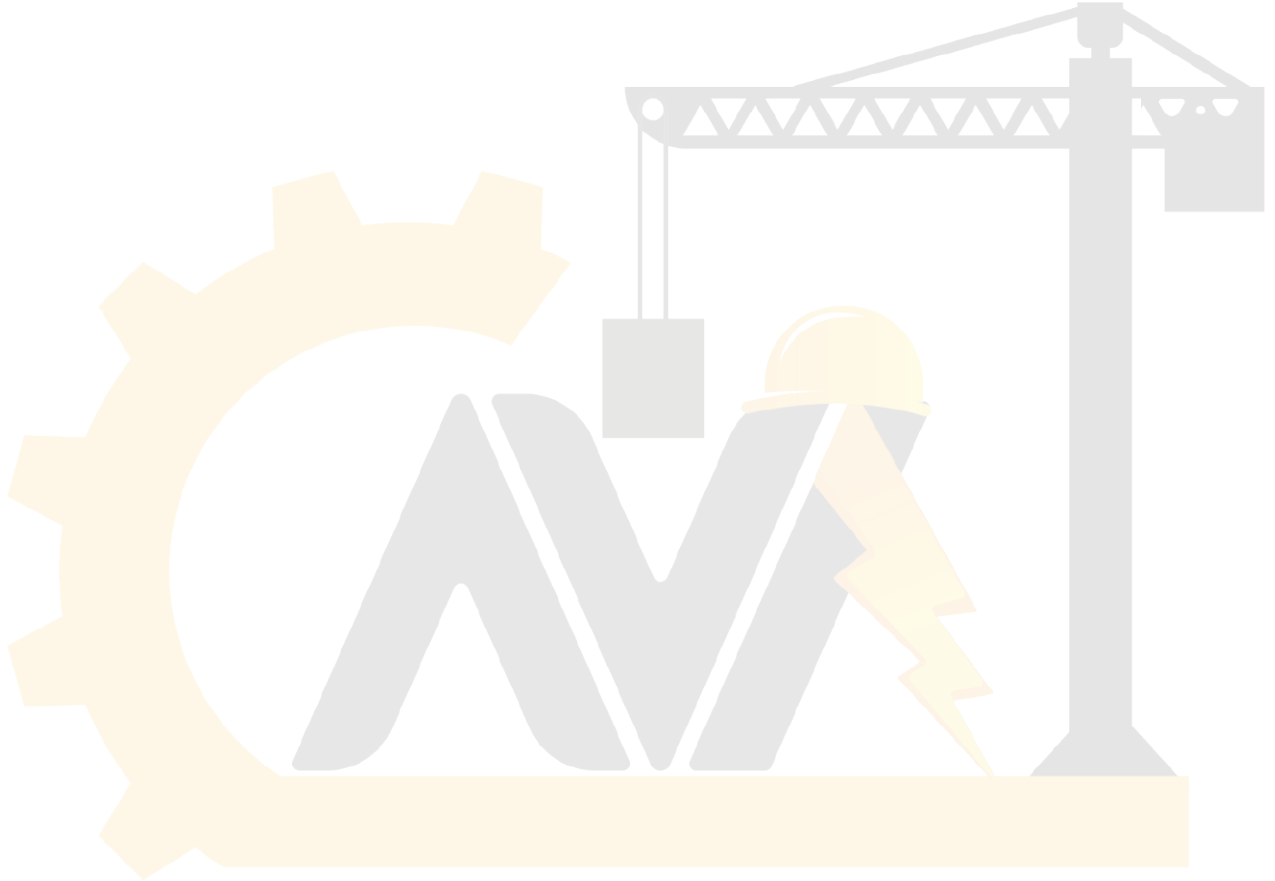

آریا ایمن آوات

4.1 GENERAL

This chapter specifies the operation, design, testing, and inspection requirements for the use of personnel lift platforms or baskets suspended from mobile or overhead cranes. This chapter implements the requirements of 29 CFR 1926.550(g) "Cranes and Derricks" and ASME B30.23, "Personnel Lifting Systems."

4.1.1 Personnel Lifting Evaluation

- a. The use of a crane to hoist employees on a personnel lift platform is prohibited, except when the erection, use, and dismantling of conventional means of reaching the worksite, such as a personnel hoist, ladder, stairway, aerial lift, elevating work platform or scaffold, would be more hazardous or is not possible because of structural design or worksite conditions.
- b. The manager specifically responsible for the overall work function to be performed shall determine that the erection, use, and dismantling of conventional means of reaching the work site (i.e., scaffold, ladder, stairway, aerial lift, or elevating work platform) would be more hazardous or is not possible because of structural design or worksite conditions.
- c. For each personnel lifting procedure, the manager responsible for the task shall authorize the use of a crane-suspended work platform and attest to the need for the operation through a written justification attesting to that need. A statement describing the operation and its time frame shall be included. The statement, after being approved by the authorizer, shall be retained at the job site.
- d. The manager specifically responsible for the overall work function shall not allow or require any operator to lift personnel under the following circumstances:
 1. The operator does not feel physically or mentally fit to perform the operation.
 2. The operator has been working for more 10 hours prior to the start of the lift or the lift will not be completed before the operator has been working for 12 hours.

3. The operator did not have at least eight hours off, immediately prior to the work shift containing the person.

4.1.2 Designated Leader

- a. The Authorizing Manager shall appoint a Designated Leader for the entire personnel lifting operation.
- b. The Designated Leader shall ensure that a pre-job plan is prepared that defines the operation. The Designated Leader shall ensure:
 1. At each new job site prior to hoisting personnel, the personnel lift platform, rigging, and hook block shall be proof-tested by a qualified inspector to 125 percent of the personnel platform's rated capacity by holding it suspended for 5 minutes with the test load suitably distributed on the personnel platform.
 2. After proof-testing, any deficiencies revealed by inspection, or by the proof test, be corrected and another proof-test conducted.
 3. Any modification to the personnel lift platform or rigging requires retesting.
 4. Test reports be kept on file and be readily available to appointed personnel.
 5. A meeting, with the qualified operator, signaler, persons to be lifted, and the person responsible for overall worksite safety to plan is held prior to the trial lift to review the procedure.
 6. The procedures for entering and leaving the personnel platform and the points at which persons will enter and leave the device be reviewed. This meeting shall be held at each new work location, and shall be repeated for any employees newly assigned to the operation.
- c. The designated leader and the crane operator shall determine that:
 1. The crane is uniformly level within 1 percent of level grade and firm footing exist under both crawler tracks or under each outrigger float. Cribbing mats under tracks or

DOE-STD-1090-2001

blocks under outrigger floats are used as necessary to provide a firm and substantial footing.

2. Cranes equipped with outriggers have outriggers extended in accordance with the manufacturer's instructions.

3. Crane systems, controls, operator aids, and safety devices are activated and functioning properly.

4. No interferences exist.

5. The total weight of the loaded personnel lift platform (including personnel) and related rigging does not exceed 50 percent of the crane rating under the planned conditions of use.

6. The personnel lift platform is not loaded in excess of its rated load capacity.

7. The number of employees occupying the platform does not exceed the number required for the work being performed.

4.1.3 Trial Lift

a. Each shift, before personnel initially enter the personnel lift platform, the operator and signaler shall conduct a trial lift. The trial lift shall include:

1. Loading the unoccupied personnel platform to at least the maximum anticipated load. Materials and tools to be used during the actual lift, if secured to prevent displacement, can be in the platform for the trial lift.

2. Making the trial lift from the location where personnel will enter the platform to each location where the platform will be hoisted and positioned. It is acceptable to perform a single trial lift on each shift for all locations to be reached from a single setup position.

b. The trial lift shall be repeated whenever:

1. The crane (mobile) is moved and set up in a new location or returned to a previously used location.

2. When the lift route is changed, unless the operator determines that the safety of the hoisted personnel is not affected.

3. If a different crane operator is assigned.

4.1.4 Lifting Operations

4.1.4.1 Pre-Lift Meeting

a. A meeting attended by the operator, the ground crew, signaler(s), person(s) to be lifted, and the designated leader shall be held each shift to plan and review procedures to be followed, including:

1. Points at which persons will enter and leave the platform.

2. Procedures for entering and leaving the platform.

3. Special precautions if personnel will perform work from the suspended platform.

b. This meeting shall be held at each new work location, and shall be repeated for any employees newly assigned to the operation.

4.1.4.2 Pre-Lift Inspection

a. After the trial lift, prior to lifting personnel:

1. A visual inspection of the crane, rigging, and personnel lift platform shall be conducted by a qualified inspector. Any defects found that create a safety hazard shall be corrected prior to hoisting personnel.

2. The platform shall be lifted a few inches and inspected to ensure that it is secure and properly balanced.

4.1.4.3 Lifting Personnel

a. Prior to hoisting personnel in a personnel lift platform ensure that:

1. No hazardous conditions exist with the platform and its associated rigging.

2. The hoist line is not wrapped around any part of the platform.

3. Hoist ropes are free of kinks.

4. Multiple-part lines are not twisted around each other.

DOE-STD-1090-2001

5. The primary attachment is centered over the platform.

6. Ropes are properly seated on drums and sheaves.

7. The crane is within 1 percent of level.

8. The crane has an anti two-block device installed and operational.

b. Employees being hoisted or working in a personnel lift platform shall:

1. Remain in continuous sight of, and in direct communication with, the operator or signaler. In situations where direct visual contact with the operator is not possible and the use of a signaler would create a hazard for that person, direct communication alone (such as a two-way radio) may be used.

2. Keep all parts of their bodies inside the suspended personnel lift platform during raising, lowering, and positioning to avoid pinch points.

3. Wear body harnesses with lanyards attached to the lower load block or overhaul ball, or to a structural member within the platform that is capable of supporting a fall impact.

4. Not stand on or work from the top rail, midrail, or toe board of the suspended personnel platform.

5. When working above water, the requirements of 29 CFR 1926.106 (Occupational Safety and Health Regulations for Construction) shall also apply.

6. When welding is being performed from the personnel lift platform, the electrode holders shall be protected from contact with metal components of the personnel platform.

c. Operators of cranes hoisting personnel in a personnel lift platform shall:

1. Before commencing or continuing the lift, consult with the designated leader when ever there is any doubt as to the safety of the lift.

2. Remain at the controls when the personnel lift platform is occupied.

3. Operate the crane so that lowering will be power-controlled (no free-fall).

4. Ensure movement of the personnel lift platform is performed in a slow, controlled, cautious manner with no sudden movements of the crane or the platform. The lifting or lowering speed shall not exceed 100 ft/min (30 m/min).

5. After the personnel lift platform is positioned, set all brakes and locks on the lift crane before personnel perform any work.

6. If the personnel lift platform cannot be landed, ensure it is tied to the structure before personnel get off or on.

7. Ensure that no lifts are made on another of the crane's load lines while personnel are suspended on the personnel lift platform.

d. Suspended personnel lift platforms shall be used only for personnel, their tools, and sufficient materials to do their work. They shall not be used for transporting bulk materials.

e. Personnel lift platforms should not be used in winds greater than 20mph (32.2 km/hr), electric storms, snow, ice, sleet, or other adverse weather conditions that could affect the safety of personnel.

f. Use tag lines to control motion of occupied personnel lift platforms unless their use creates an unsafe condition.

g. Cranes shall not travel while personnel are in the platform. Exceptions to this provision shall be approved by the manager specifically responsible for the overall work function and precautions to be taken documented in the personnel lift plan.

4.2 MOBILE CRANES

Mobile cranes are designed and intended for handling materials, not personnel. In addition to the general requirements in Section 4.1, "General," the following requirements shall be met when lifting personnel with a mobile crane:

a. Personnel are permitted to ride only in one of the following:

1. A personnel lift platform that is supported from the crane's hook which meets the requirements of Section 4.4, "Personnel Platform."

2. A personnel basket attached directly to the boom which is approved by the crane manufacturer.

b. Cranes and derricks with variable-angle booms shall be equipped with a boom-angle indicator that is readily visible to the operator.

c. Cranes with telescoping booms shall be equipped with a device to indicate clearly to the operator, at all times, the boom's extended length, or an accurate determination of the load radius to be used during the lift shall be made prior to hoisting personnel.

d. A positive-acting device shall be used that prevents contact between the load block or overhaul ball and the boom tip (anti-two-blocking device), or a system shall be used that deactivates the hoisting action before damage occurs in the event of a two-blocking situation (two-block damage-prevention feature).

e. Cranes having booms in which lowering is controlled by a brake without aid from other devices which slow the lowering speeds is prohibited.

f. Crane load lines shall be capable of supporting, without failure, at least seven times

the maximum intended load, except where rotation resistant rope is used, the lines shall be capable of supporting without failure, at least ten times the maximum intended load.

g. Hydraulic cranes shall have check valves or other devices that will prevent uncontrolled movement in the event of system failure, engine failure, or hose rupture.

h. Cranes shall have a means to prevent retraction of hydraulically or pneumatically activated outriggers or stabilizers in the event a hydraulic or pneumatic line fails.

i. Pendant supported, jib type, boom extensions without positive stops are prohibited for personnel lifting.

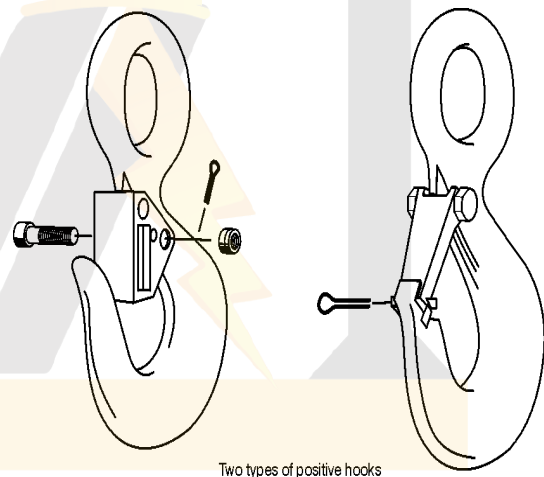

Figure 4-1. Positive Hooks

j. Hooks on overhaul ball assemblies, lower load blocks, or other attachment assemblies shall be of the type that can be closed and locked, eliminating the hook throat opening. (See Figure 4-1). Alternatively, an alloy anchor type shackle with a bolt, nut and retaining pin may be used.

4.4 PERSONNEL LIFT PLATFORM

4.4.1 Platform Design and Construction

There is no attempt to comprehensively address platform design and construction in this chapter. Nevertheless, because many platform design and construction features can be observed and should be known by the platform user, (See Figure 4-2) the following key design and construction requirements are presented:

- a. The personnel lift platform and suspension system shall be designed by a qualified person competent in structural design and familiar with national consensus standards governing personnel platform design.
- b. All welding of the platform shall be performed by a qualified welder in accordance with ANSI/AWS D1.1. Where special steels or other materials are used, the manufacturer shall provide welding procedures. Welds shall be inspected by a qualified inspector
- c. The personnel lift platform shall have:
 1. A minimum design factor of five.
 2. A plate specifying its empty weight and its rated load capacity or maximum intended load.
 3. Perimeter protection consisting of a top rail approximately 45 in. (115 cm) high, a toe board at least 4 in. (10 cm) high, and a midrail approximately halfway between the top rail and the toe board.
 4. A grab rail inside the personnel lift platform to minimize hand exposure.
 5. Anchorage points within the platform for attaching personnel fall protection lanyards.
 6. The sides of the platform enclosed from the toe board to the midrail with solid construction or expanded metal having openings no greater than ½ in. (1.27 cm).
 7. Platform access gates, including sliding or folding types, if installed, shall have a positive acting device to restrain the gate from accidental opening. Swinging type access gates shall open only to the interior of the personnel lift platform.

8. Rough edges exposed to contact by employees surfaced (ground smooth) to prevent injury.

9. High-visibility color or marking for easy identification.

d. In addition to wearing hard hats, personnel shall be protected by overhead protection on the personnel lift platform when there is an overhead hazard. Sufficient headroom shall be provided to allow employees to stand upright in the platform.

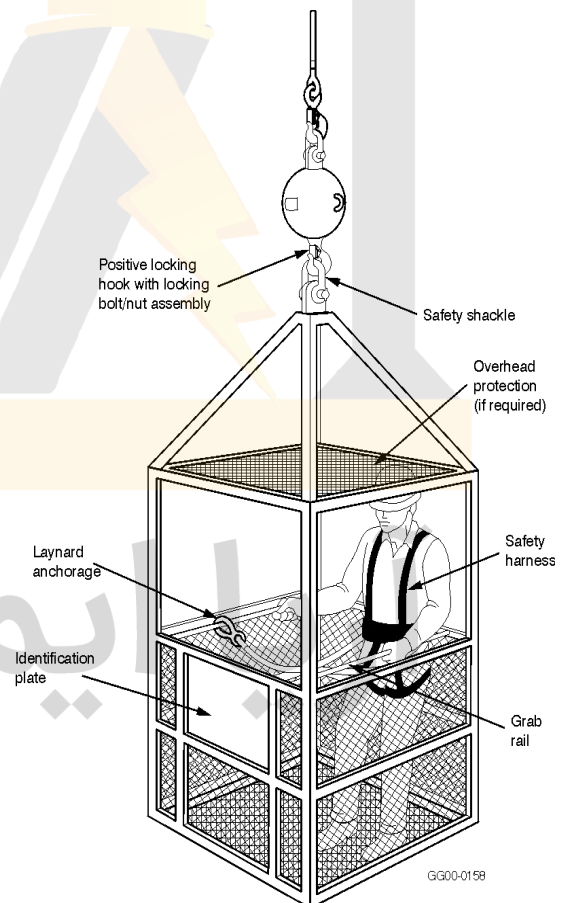

Figure 4-2. Personnel Lift Platform

4.5 INSPECTIONS

All equipment used in the lifting of personnel shall be inspected, tested, and maintained to protect against failure during lifting operation.

4.5.1 Frequent Inspection

4.5.1.1 General

a. The platform manufacturer shall furnish complete inspection criteria for the platform users. The criteria shall address all inspection frequency classifications and shall cover:

1. The platform
2. Rigging components
3. Fasteners
4. All safety features and attachments.

4.5.1.2 Personnel Lift Platform

a. Prior to initial use and at each new job the platform shall be inspected by a qualified inspector in accordance with the instructions provided by the manufacturer.

b. The platform, suspension system, attachment points, and any motion controls shall be inspected at least each day, before use, by a designated person. The inspection is to identify conditions that have been specifically indicated by the platform manufacturer, or a qualified person, as potentially creating a hazardous operating condition. Visually inspect items such as the following:

1. Platform and suspension system markings to ensure all information is legible.
2. Platform structure:
 - i. Load supporting members, welds and bolts.
 - ii. Perimeter protection; top rail, midrail, toe board, and barrier form toe board to midrail.
 - iii. Fall protection device anchorage points.

- iv. Gate locking mechanisms.
- v. Platform flooring.
- vi. Suspension attachment points.

3. Attachment mechanisms.

- i. Master links, shackles, slings, bolt-ups, etc.

4. Special purpose items:

- i. Overhead protection.
- ii. Platform controls

c. For frequent inspections, dated records for the hoisting equipment and personnel lift platform shall be made and kept by the platform user for the duration of the personnel lift operation.

4.5.2 Periodic Inspection

4.5.2.1 Personnel Lift Platform

a. At least once every 12 months, or as required by the personnel lift platform manufacturer, a periodic inspection of the platform shall be performed by a qualified inspector in accordance with the instructions provided by the manufacturer.

b. Platforms which have been out of service for 12 or more consecutive months shall receive a periodic inspection prior to use.

c. Dated inspections records for the platform shall be made. The last periodic inspection records shall be kept with the platform and available for review.

4.5.2.2 Hoisting Equipment

a. Hoisting equipment shall be inspected in accordance with requirements of Chapter 7, "Overhead & Gantry Cranes," or Chapter 9, "Mobile Cranes."

4.7 LIFTING PERSONNEL NEAR ELECTRICAL POWER LINES

4.7.1 General

- a. When lifting personnel near electrical power lines, it is advisable to perform the lift so there is not possibility of the crane, load line, or personnel platform becoming a conductive path.
- b. Cranes shall not lift personnel under electrical power lines if any combination of boom, personnel platform, load line, or machine components will enter the prohibited zone (See figure 4-3).
- c. Lifting personnel near electrical power lines is not allowed unless there is no less hazardous way to perform the job. The following conditions must be considered when lifting personnel near electrical power lines:

4.7.2 Condition A

- a. Power Lines are de-energized and grounded. (The safest and preferred condition). The following steps shall be taken when lifting personnel in Condition A:

1. The electrical utility organization shall de-energize the power lines.
2. As a minimum, the power lines shall be visible grounded to avoid the possibility of electrical feedback.
3. Before lifting personnel, a qualified representative from the electrical utility organization shall be on site to verify that the power lines are de-energized and grounded.
4. In addition to Electrical Hazard Warning Signs required on all mobile cranes, Electrical Hazard Warning Signs shall be posted inside the personnel lift platform.
5. Proximity warning devices, insulated links or boom cages, if used, shall not be a substitute for any requirements of this section.

4.7.3 Condition B

- a. Power lines are energized with the equipment outside the prohibited zone but working within a fully extended boom length of

the prohibited zone. Regardless of whether the crane boom will be fully extended, the fully extended boom length shall be considered (See figure 4-4). The following steps shall be taken when lifting personnel in Condition B:

1. A meeting, on the job site, between the Personnel Lift Authorizing Manager, the Designated Leader, and a qualified representative of the electrical utility organization shall take place. Procedures to safely complete the lift shall be established.
2. The clearance specified in Table 4-1 shall be considered.
3. Power line movements, horizontal and vertical, caused by wind shall be considered.
4. The required clearances to the power lines shall be continuously monitored by a signal person, also called a "wire watcher," whose sole responsibility is to maintain proper clearance. The "wire watcher" shall be in constant communication with the crane operator.
5. Tag lines to the personnel platform, when used, shall be of a nonconductive type, such as dry rope made of polypropylene or polyethylene fiber.
6. No person outside the platform or crane cab shall be permitted to touch the crane, load line or platform unless the "wire watcher" indicates it is safe.
7. Operation of the boom or the platform over power lines should be avoided. Poor perception of distance and multiple potential contact points make this very hazardous.
8. Consider attaching ribbons, balls, or other visibility enhancing devices, to the power line to aid in visually locating the prohibited zone.
9. In addition to Electrical Hazard Warning Signs required on all mobile cranes, Electrical Hazard Warning Signs shall be posted inside the personnel lift platform.

10. Proximity warning devices, insulated links or boom cages, if used, shall not be a substitute for any requirements of this section.

4.7.4 Condition C

a. Power lines are energized with the equipment inside the prohibited zone (See Table 4-1). **Lifting personnel in this condition is strictly prohibited.**

Table 4-1. Safe working distance from power lines.

a. When operating near high-voltage power lines:			
Normal voltage (phase to phase)			Minimum required clearance
		to 50 kV	10 ft (3.1 m)
Over	50	to 200 kV	15 ft (4.6 m)
Over	200	to 350 kV	20 ft (6.1 m)
Over	350	to 500 kV	25 ft (7.6 m)
Over	500	to 750 kV	35 ft (10.7 m)
Over	750	to 1000 kV	45 ft (13.7 m)

b. While in transit with no load and boom or mast lowered:			
Normal voltage (phase to phase)			Minimum required clearance
		to 0.75 kV	4 ft (1.2 m)
Over	0.75	to 50 kV	6 ft (1.3 m)
Over	50	to 345 kV	10 ft (3.5 m)
Over	345	to 700 kV	16 ft (4.9 m)
Over	750	to 1000 kV	20 ft (6.1 m)

آریا ایمن آوات

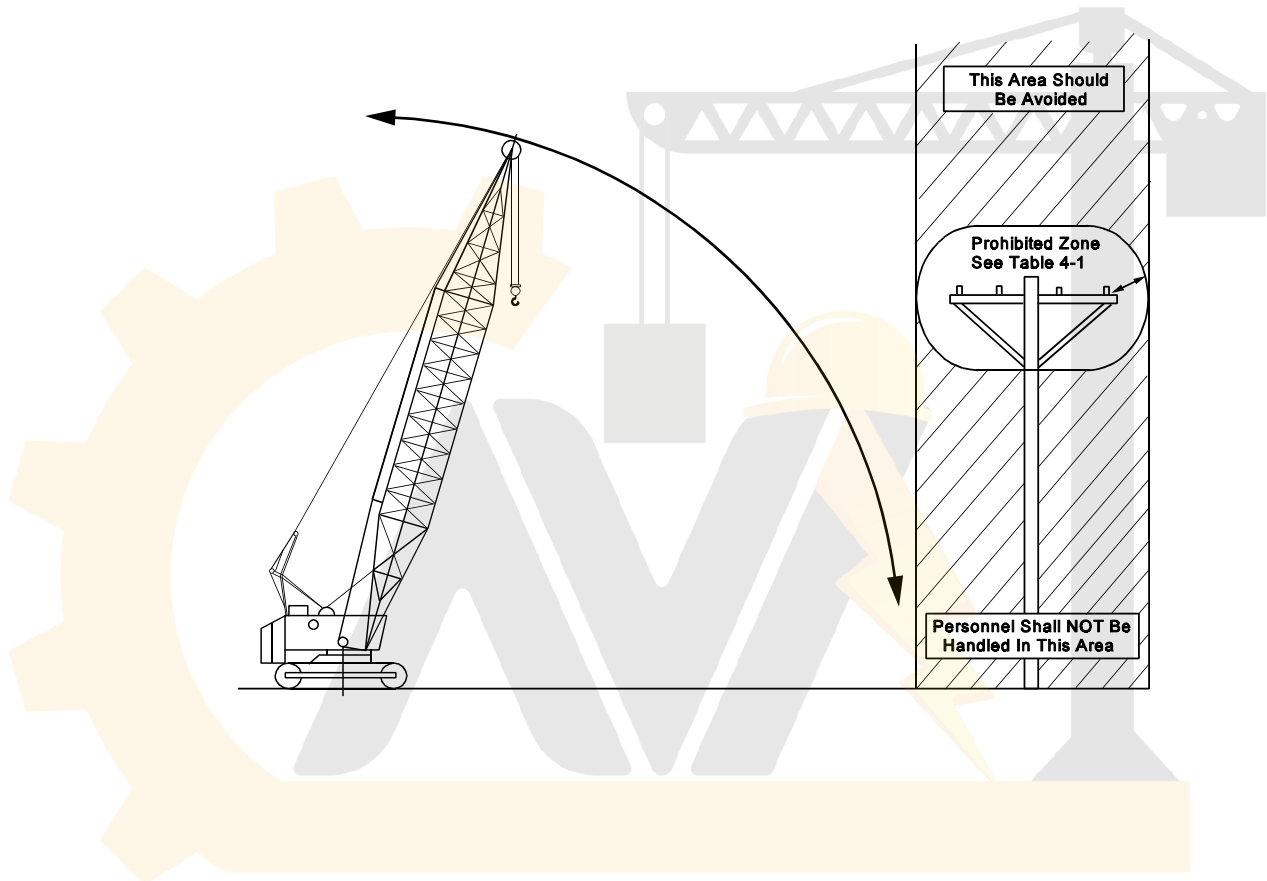

Figure 4-3 Danger Zone for Cranes and Lifting Personnel Near Electrical Transmission Line

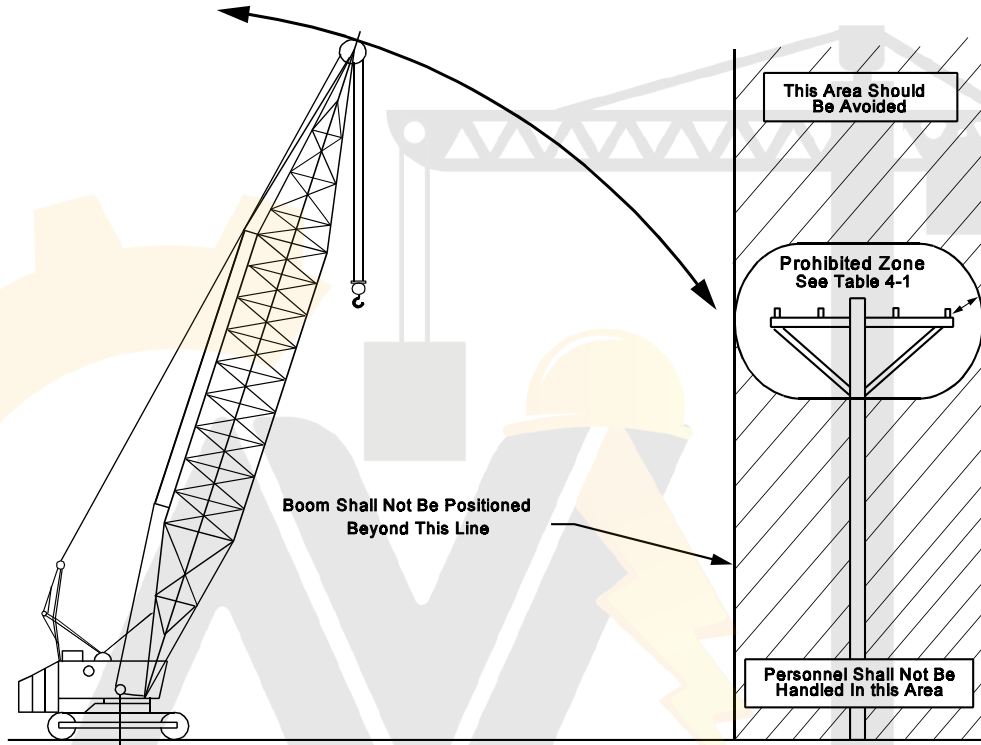

Figure 4-4. Danger Zone For Cranes Lifting Personnel Near Electrical Transmission Lines.

آریا ایمن آوات

DOE-STD-1090-2001

**EXHIBIT I
(SAMPLE FORM)**

BRIDGE, WALL, GANTRY CRANE LOAD TEST FORM

EQUIPMENT NO. _____ MAKE _____ RATED CAPACITY _____ DATE _____

LOAD TEST INSPECTION REPORT

The following checklist identifies the items to be inspected prior to the load test. Any unusual conditions observed during the inspection should be noted in the Remarks section.

- NOTES:**
1. Craftsmen shall initial and date all tests, work, and inspections completed below.
 2. Qualified inspector shall verify all steps prior to load test.

NO.	CRANE ITEM	DEFECT	OK	NA	NO.	CRANE ITEM	DEFECT	OK	NA
1	Load Hook & Blocks				18	Controllers			
2	Wire Rope and End Connections				19	Relays and Coils			
3	Handrails, Walkways, and Ladders				20	Conductors and Collectors			
4	Bridge and Trucks				21	Panel Wiring			
5	Bridge Wheels and Bearings				22	Resistors			
6	Trolley and Rails				23	Bypass Switches			
7	Trolley Wheels and Bearings				24	Limit Switches			
8	Crane Alignment				25	Contactors (Electrical)			
9	Runway Rail & Clamps				26	Motors			
10	Bumpers/Endstops				27	Gauges			
11	Brake System				28	Lighting System			
12	Drive Shafts, Gears, Couplings & Bearings				29	Heater and Switches			
13	Pawls, Ratchets, Spuds, & Windlocks				30	Operator's Cab			
14	Sheaves				31	Safety			
15	Warning Devices				32	Chain and Sprockets			
16	Capacity Signs				33	Structural			
17	Main Disconnect				34	Wire Rope Drum and Machinery Foundation			

REMARKS (Unusual conditions—noises, structural cracks, misalignment, etc.)

CHAPTER 6 PERSONNEL QUALIFICATION AND TRAINING

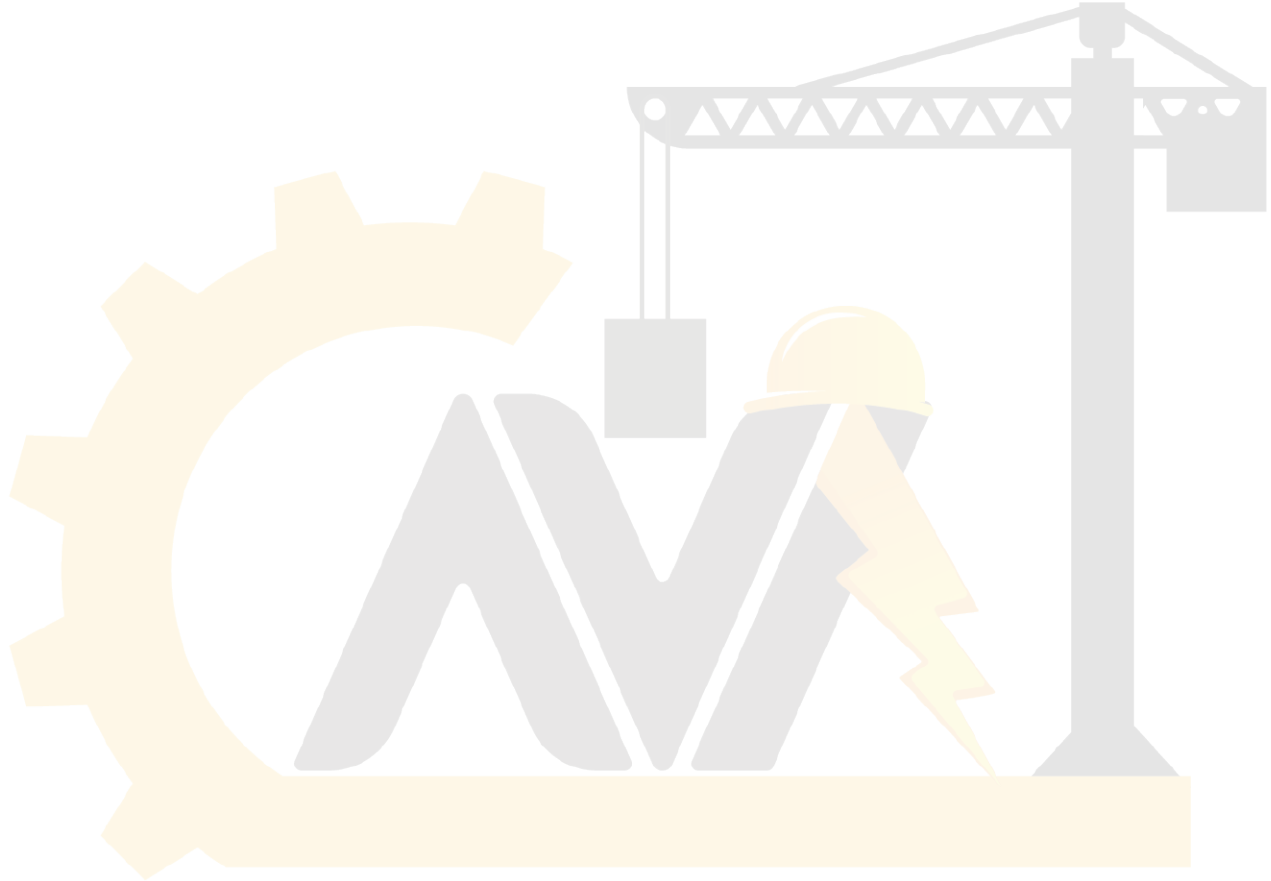

آریا ایمن آوات

6.1 GENERAL

a. This chapter delineates the requirements for the qualification and training of operators, riggers, inspectors, maintenance personnel, trainers, persons-in-charge (PIC), designated leaders, and first-line supervisors.

b. Personnel who are designated to operate equipment or perform work covered by this standard shall be qualified and trained to the level of proficiency consistent with assigned tasks.

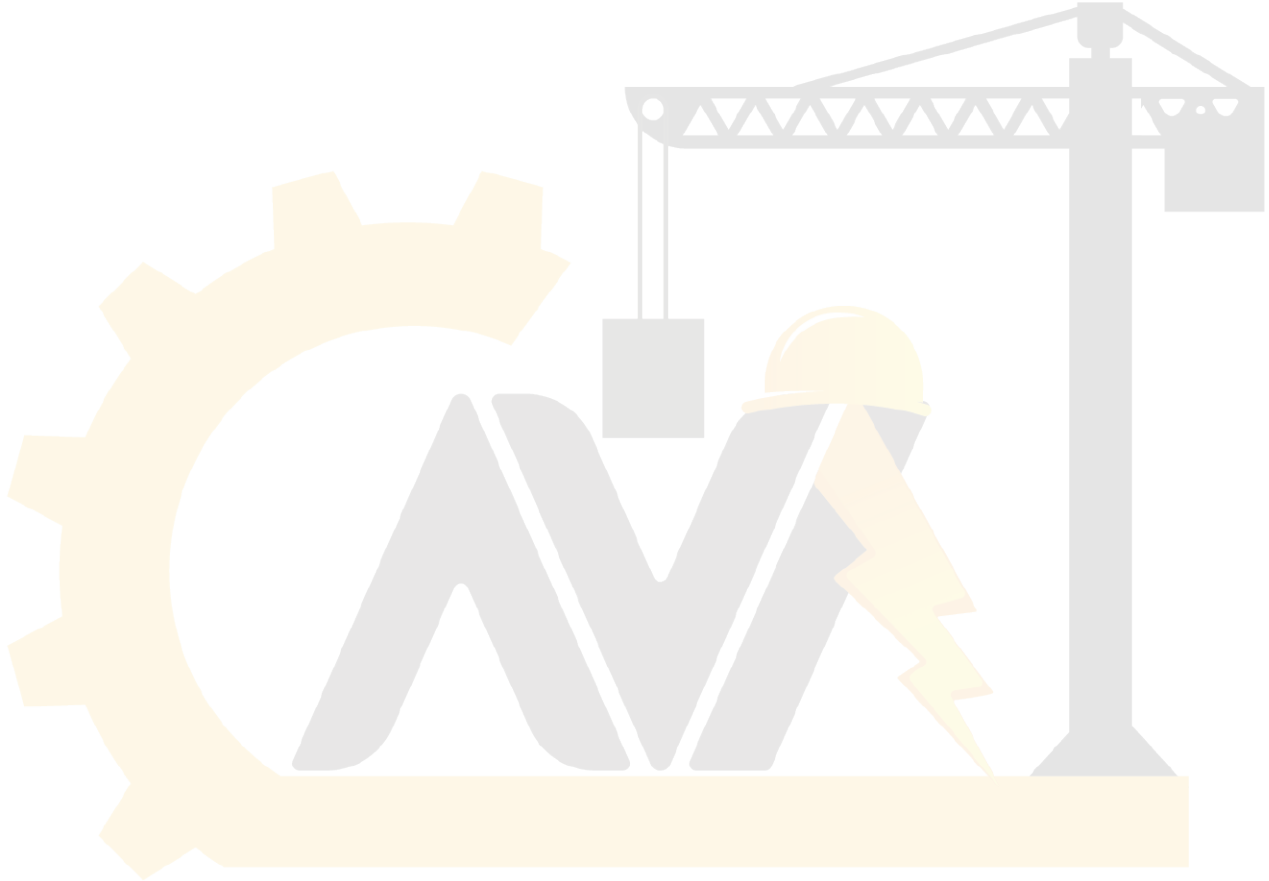

آریا ایمن آوات

6.2 QUALIFICATION

6.2.1 General

Only qualified personnel or trainees, under the direct supervision of qualified personnel, who meet the following requirements shall be allowed to rig, operate, inspect, or perform maintenance on cranes, hoists, or powered forklift trucks:

- a. Be at least 18 years old.
- b. Understand spoken and written English or a language generally in use at the work location.

6.2.2 Operators of Cab-Operated and Pulpit-Operated Cranes

a. Operators and operator trainees shall meet the following physical qualifications.

1. Have vision of at least 20/30 Snellen in one eye and 20/50 in the other, with or without corrective lenses. Operators whose jobs do not require binocular vision (operation of cranes with television cameras or periscope optics) shall have distant visual acuity of 20/30 in one eye and no specific visual requirement for the other eye.

2. Be able to distinguish colors, regardless of position, if color differentiation is required for operation.

3. Have adequate hearing, with or without a hearing aid, for a specific operation.

4. Have physical strength, coordination, and sufficient reaction speed to meet the demands of equipment operation.

5. Show no evidence of physical defects or of emotional instability that could be a hazard to themselves or others, or which, in the opinion of the examiner, could interfere with their safe performance; such evidence may be sufficient cause for disqualification. In these cases, medical judgments and tests may be required.

6. Show no evidence of being subject to seizures or to loss of physical control; such evidence shall be sufficient reason for disqualification. Medical examinations may be required to determine these conditions.

7. Have normal depth perception, field of vision, manual dexterity, coordination, and no tendencies to dizziness or similar potentially hazardous characteristics.

8. Have no detectable or known disease or physical restriction that would render them incapable of safely operating equipment or carrying out rigging duties. Where any deficiency of an upper or lower extremity exists, the acceptability of a candidate shall be the decision of the supervisor, after consulting with the designated physician.

- b. Operators shall be required by the employer to satisfactorily pass a written examination covering operational characteristics, controls, and emergency control skills.

- c. Operators shall be required by the employer to pass a practical operating skill evaluation. Qualification shall be limited to the type of equipment for which the operator is being evaluated. The actual or simulated operation shall enable trainees to demonstrate basic knowledge and skills at a level that ensures the safety of personnel and equipment.

6.2.3 Operators of Mobile Cranes

a. Operators and operator trainees shall meet the following physical qualifications.

1. Have vision of at least 20/30 Snellen in one eye and 20/50 in the other, with or without corrective lenses.

2. Be able to distinguish colors, regardless of position, if color differentiation is required for operation.

3. Have adequate hearing, with or without a hearing aid, for a specific operation.

4. Have physical strength, coordination, and sufficient reaction speed to meet the demands of equipment operation.

5. Show no evidence of physical defects or of emotional instability that could be a hazard to themselves or others, or which, in the opinion of the examiner, could interfere with their safe performance; such evidence may be sufficient

cause for disqualification. In these cases, medical judgments and tests may be required.

6. Show no evidence of being subject to seizures or to loss of physical control; such evidence shall be sufficient reason for disqualification. Medical examinations may be required to determine these conditions.

7. Have normal depth perception, field of vision, manual dexterity, coordination, and no tendencies to dizziness or similar potentially hazardous characteristics.

8. Have no detectable or known disease or physical restriction that would render them incapable of safely operating equipment or carrying out rigging duties. Where any deficiency of an upper or lower extremity exists, the acceptability of a candidate shall be the decision of the supervisor, after consulting with the designated physician.

9. Shall successfully pass with a negative result, a substance abuse test. The level of testing will be determined by the standard practice for the industry where the crane is employed and this test shall be confirmed by a recognized laboratory service.

10. Operator physical examinations shall be required every three years or more frequently if supervision deems it necessary.

b. Operators shall be required by the employer to satisfactorily pass a written examination covering operational characteristics, controls, and emergency control skills such as response to:

1. Fire.
2. Power line contact.
3. Loss of stability.
4. Control malfunction.

5. As well as characteristic and performance questions appropriated to the crane type for which qualifications is sought.

c. Operators shall demonstrate their ability to read, write, comprehend and exhibit arithmetic skills and load/capacity chart usage, in the language of the crane manufacturer's operation and maintenance instruction materials.

d. Operators shall satisfactorily complete a combination written and verbal test on load/chart usage that covers a selection of the configurations (the crane may be equipped to handle) for the type crane for which qualification is being sought.

e. The operator shall complete a practical operating skill evaluation test (actual or simulated), demonstrating proficiency and basic knowledge in handling the specific type crane for which the operator is being evaluated, including:

1. Pre-start and post-start inspection.
2. Maneuvering skills.
3. Shutdown.
4. Securing the crane.

f. Qualification shall be limited to the type of equipment for which the operator is being evaluated.

g. Trainee qualification requirements shall include but not limited to the following:

1. Satisfactory completing of a written examination covering safety, operational characteristics and limitations, and controls of the type crane for which they are being qualified.

2. Demonstrate their ability to read, write, comprehend, and exhibit arithmetic skills and load/capacity chart usage, in the language of the crane manufacturer's operations and maintenance instruction materials.

3. Satisfactory completion of a combination written and verbal test on load/capacity chart usage covering various crane configurations.

6.2.4 Operators of Truck Mounted Cranes - Capacity 1 Ton or Less

a. Physical qualifications shall be based on specific job requirements.

b. Operators shall be required by their employer to pass a practical operating skill evaluation. Qualification shall be limited to the type of equipment for which the operator is being evaluated.

6.2.5 Operators of Floor-Operated Cranes

- a. Physical qualifications shall be based on specific job requirements.
- b. Operators shall be required by their employer to pass a practical operating skill evaluation. Qualification shall be limited to the type of equipment for which the operator is being evaluated.
- c. The actual or simulated operation shall enable operators to demonstrate basic knowledge and skills at a level that ensures the safety of personnel and equipment.

6.2.6 Operators of Forklift Trucks

- a. Physical qualifications shall be based on specific job requirements.
- b. Operators shall be required by the employer to pass a practical operating skill evaluation. Qualification shall be limited to the type of forklift for which the operator is being evaluated.
- c. The actual or simulated operation shall enable operators to demonstrate basic knowledge and skills at a level that ensures the safety of personnel and equipment.

6.2.7 Riggers

Riggers shall be required to pass a practical rigging skill evaluation that requires the use of rigging equipment in safe configurations. The actual or simulated operation shall enable personnel to demonstrate basic knowledge and skills at a level that ensures the safety of personnel and equipment.

6.2.8 Person-In-Charge (PIC)

The PIC shall have the necessary knowledge and experience of the specific type of equipment and the hazards of critical lifts to direct the safe completion of the operation. The PIC shall understand the rules and procedures implemented at the site to ensure that the following are completed:

- a. Necessary administrative requirements.
- b. Personnel assignments and responsibilities.

- c. Selection of proper equipment/tools.
- d. Recognition and control of hazardous or unsafe conditions.
- e. Job efficiency and safety.
- f. Critical-lift documentation.

In addition, the PIC shall

- a. Direct operations in the case of an accident.
- b. Exercise authority to start and stop work activities.

6.2.9 Designated Leader

The designated leader shall have sufficient knowledge and experience to accomplish the following responsibilities:

- a. Ensure that personnel involved understand how the lift is to be made.
- b. Ensure that the weight of the load is determined and that proper equipment and accessories are selected.
- c. Survey the lift site for hazardous or unsafe conditions.
- d. Ensure that equipment is properly set up and positioned.
- e. Ensure that a signaler is assigned, if required, and is identified to the operator.
- f. Direct the lifting operation to ensure that the job is done safely and efficiently.
- g. Stop the job when any potentially unsafe condition is recognized.
- h. Direct operations if an accident or injury occurs.

6.2.10 Inspectors

- a. Qualified inspectors shall have the necessary knowledge and experience to properly inspect hoisting and rigging equipment.
- b. Employees who operate cranes to perform crane inspections shall be trained and qualified to operate the crane on which the inspection is being performed. See general and crane specific qualification requirements in Section 6.2. "Qualification."

c. Crane operation by crane inspectors shall be limited to those crane functions necessary to perform the inspection on the crane.

6.2.11 Instructors

Instructors responsible for developing or presenting hoisting and rigging training programs shall meet the qualification standards specified by the responsible training organization.

6.2.12 First-Line Supervisors

The first-line supervisor of hoisting and rigging operations should be knowledgeable of the specific types of hoisting and rigging operations under their supervision and their operational hazards. The supervisor shall be familiar with applicable rules and procedures implemented at the site to ensure that hoisting and rigging work under their control is done efficiently and safely, with safety as top priority. Supervisors should ensure that employees fully understand the importance of safety and that they recognize their own authority and responsibility to stop work when safety is questionable.

6.2.13 Maintenance Personnel

a. Employees who operate cranes to perform crane maintenance shall be trained and qualified to operate the cranes on which maintenance is being performed. See general and crane specific qualification requirements in Section 6.2. "Qualification."

b. Crane operation by maintenance personnel shall be limited to those crane functions necessary to perform maintenance on the crane or to verify the performance of the crane after maintenance has been performed.

c. Employees who perform maintenance activities on equipment covered by this standard should have an understanding of the following criteria:

1. The tools to safely accomplish their work.
2. Access to operating instructions to perform adjustments.
3. Parts information furnished by the manufacturer or the responsible maintenance/engineering organization.
4. Manufacturers' recommendations as to points and frequency of lubrication and levels and types of lubricant to be used.
5. Maintenance and repair procedures recommended by the manufacturer or responsible maintenance/engineering organization.
6. Wiring diagrams.
7. Documentation requirements for maintenance and repair.

آریا ایمن آوات

6.3 TRAINING

6.3.1 General

a. Organizations that employ personnel who operate, rig, inspect, or perform maintenance on equipment covered in this standard shall provide training programs, including a means of evaluation, to ensure that the personnel are competent to perform the operations.

b. Training programs for operators should address two levels of required performance.

1. Persons who may operate pendant-controlled cranes, manual hoists, and forklifts as an incidental part of their normal work assignment.

2. Persons whose principal assignment is the performance of hoisting and rigging work.

c. The training organization shall use training methods best suited for the students and the subject material. This may include, but is not limited to, computer-aided training, classroom training, simulated field training, on-the-job training (OJT), and training by equipment manufacturer or commercial training companies.

d. Score standards shall be set for each examination by the training organization. The minimum passing score will depend on the subject, testing technique, and test difficulty. Management shall determine the course of action for persons receiving negative evaluations.

2. Instructor review of the applicant's knowledge, including results of written and oral evaluation, and witnessing a demonstration of the operator's skills.

c. Operators should be able to demonstrate a knowledge of equipment operating characteristics, capabilities, limitations, effects of variables, safety features, and operating procedures. The following checklist contains basic factors with which an operator should be familiar. This checklist must be tailored to suit actual conditions.

1. Operating characteristics.
2. Environmental hazards—weather.
3. Electrical hazards.
4. Traveling with load.
5. Traveling without load.
6. Lifting personnel.
7. Inspections/tests.
8. Load weight estimation.
9. Emergency procedures.
10. Rigging.
11. Lessons learned.
12. Hand signals.
13. Load dynamics.
14. Applicable standards and regulations.
15. Critical lifts.
16. Safety features of equipment.
17. Terminology and definitions.
18. Ropes and reeving.
19. Two-blocking.
20. Records and documents.
21. Limit switches, warning signals.

6.3.2 Operators of Cab-Operated, Pulpit-Operated, and Floor-Operated Cranes

a. Only qualified and authorized operators or operator trainees under the direct supervision of a qualified operator shall be permitted to operate cab-operated, pulpit-operated, and floor-operated cranes.

b. The initial training of operators shall include:

1. Applicant training on equipment for which qualification is sought, under the direction of a qualified operator or instructor who is designated by management to instruct in the operation of hoisting equipment.

- 22. Operating practices.
- 23. Fire protection.
- 24. Crane components.
- 25. Access and egress.
- 26. Warning devices.

d. Operators should be able to demonstrate a knowledge of equipment operating characteristics, capabilities, limitations, effects of variables, safety features, and operating procedures.

6.3.3 Mobile Crane Operators

a. Only qualified and authorized operators or operator trainees under the direct supervision of a qualified operator shall be permitted to operate mobile cranes.

b. Operators shall meet the criteria specified in paragraphs 6.3.2.b and c, and they should also be able to demonstrate an understanding of the following:

- 1. Stability.
- 2. Load charts.
- 3. Crane setup.
- 4. Refueling.
- 5. Lifting operations involving multiple cranes.
- 6. Assembly and disassembly.
- 7. Outriggers.
- 8. Operator aids.

6.3.5 Forklift Truck Operators

a. Only qualified and authorized operators shall be permitted to operate powered forklift trucks. Operator trainees may operate powered forklift trucks under the direct supervision of a qualified operator or trainer and only where such operation does not endanger the trainee or other employees.

b. The initial training of operators shall include:

- 1. A combination of formal instruction (e.g., lecture, discussion, interactive computer learning, videotape, written material).
- 2. Practical training (demonstrations performed by the trainer and practical exercises performed by the trainee).
- 3. Evaluation of the operator's performance in the workplace including results of written and oral evaluation, and witnessing a demonstration of the operator's skills.

c. The following checklist contains basic factors with which a forklift truck operator should be familiar. This checklist must be tailored to suit actual conditions.

- 1. Operating instruction, warnings, and precautions for the type of forklift truck the operator will be authorized to operate.
- 2. Differences between the forklift truck and the automobile.
- 3. Forklift truck controls and instrumentation:
 - i. Where they are located.
 - ii. What they do.
 - iii. How they work.
- 4. Engine or motor operation.
- 5. Steering and maneuvering.

6.3.4 Operators of Truck Mounted Cranes - Capacity 1 Ton or Less

a. Only qualified and authorized operators or operator trainees under the direct supervision of a qualified operator shall be permitted to operate truck mounted cranes - capacity 1 ton or less.

b. The initial training of operators shall include applicable training on equipment for which qualification is sought, under the direction of a qualified operator or instructor.

c. Instructor review of the applicant's knowledge, shall include results of written and/or oral evaluation, and witnessing a demonstration of the operator's skills.

CHAPTER 7 OVERHEAD AND GANTRY CRANES

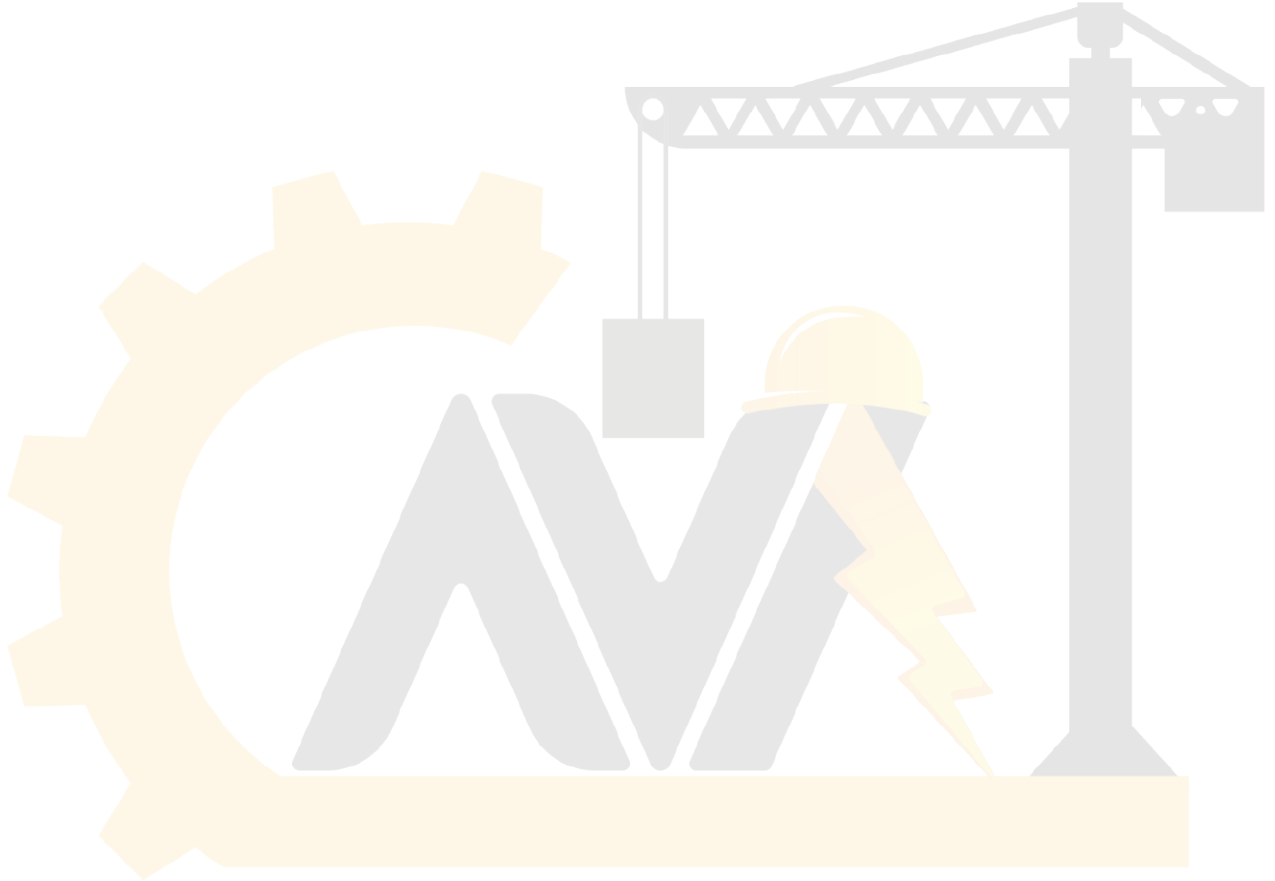

آریا ایمن آوات

7.1 GENERAL

Overhead and gantry cranes include top-running single- or multiple-girder bridge with top-running trolley hoists (Figure 7-1), top-running single-girder bridge with underhung trolley hoists (Figure 7-2), and monorails/underhung cranes (Figure 7-3).

7.1.1 Operator Training/Qualification

Operators of overhead cranes shall be trained and qualified as required in Chapter 6, "Personnel Qualification and Training."

7.1.2 Rated-Load Marking

The rated capacity shall be marked on each side of the crane. If the crane has more than one hoisting unit, each hoist shall have its rated capacity marked on it or on its load block. Markings on the bridge, trolley, and load block shall be legible from the ground or floor.

7.1.3 Modification

Cranes may be modified or rerated provided that the modifications or supporting structures are analyzed thoroughly by a qualified engineer or by a manufacturer of cranes. Modifications and reratings must be approved by the cognizant safety organization. A rerated crane, or one whose load-supporting components have been modified, shall be tested in accordance with Section 7.3, "Testing." The new rated capacity shall be displayed in accordance with Section 7.1.2, "Rated-Load Marking."

7.1.4 Egress

On cab-operated cranes, there shall be at least two means of egress from the crane, remote from each other, and arranged to permit departure under emergency conditions.

7.1.5 Hoist Brakes

a. Each independent hoisting unit shall be equipped with at least one holding brake applied directly to the motor shaft or some part of the gear train.

b. Each independent hoisting unit (except worm-gear hoists, the angle of whose worm prevents the load from accelerating as it is being lowered) shall be equipped with a controlled-braking means in addition to the holding brake to control speed of lowering.

c. Holding brakes on hoists shall be applied automatically when power is removed.

7.1.6 Power Shutoff

a. The power supply for the runway conductors shall be controlled by a switch or circuit-breaker located on a fixed structure, accessible from the floor, and capable of being locked in the OPEN position.

b. On cab-operated cranes, an enclosed switch or circuit-breaker (with provisions for locking in the OPEN position) shall be provided in the leads from the runway conductors. A means of opening this device shall be located within reach of the operator when the operator is in the operating position. When the operator opens this switch or circuit-breaker, the holding brakes should set.

c. On floor, remote, or pulpit-operated cranes, an enclosed disconnect device shall be provided in the leads from the runway conductors. This device shall be mounted on the bridge or footwalk near the runway collectors. There shall be provisions for locking the device in the OPEN position unless the crane is the only load on a lockable switch or circuit-breaker that is accessible from the floor. One of the following types of floor, remote, and pulpit-operated disconnects shall be provided.

1. A nonconductive rope attached to the main disconnect device on a floor-operated crane. If this is selected, the rope shall be suspended adjacent to the operating ropes if manual controllers are used, or near the pendant push-button station if magnetic controls are used.

2. An under-voltage trip for a main circuit-breaker, operated by an emergency stop button in the pendant push-button station or the pulpit.

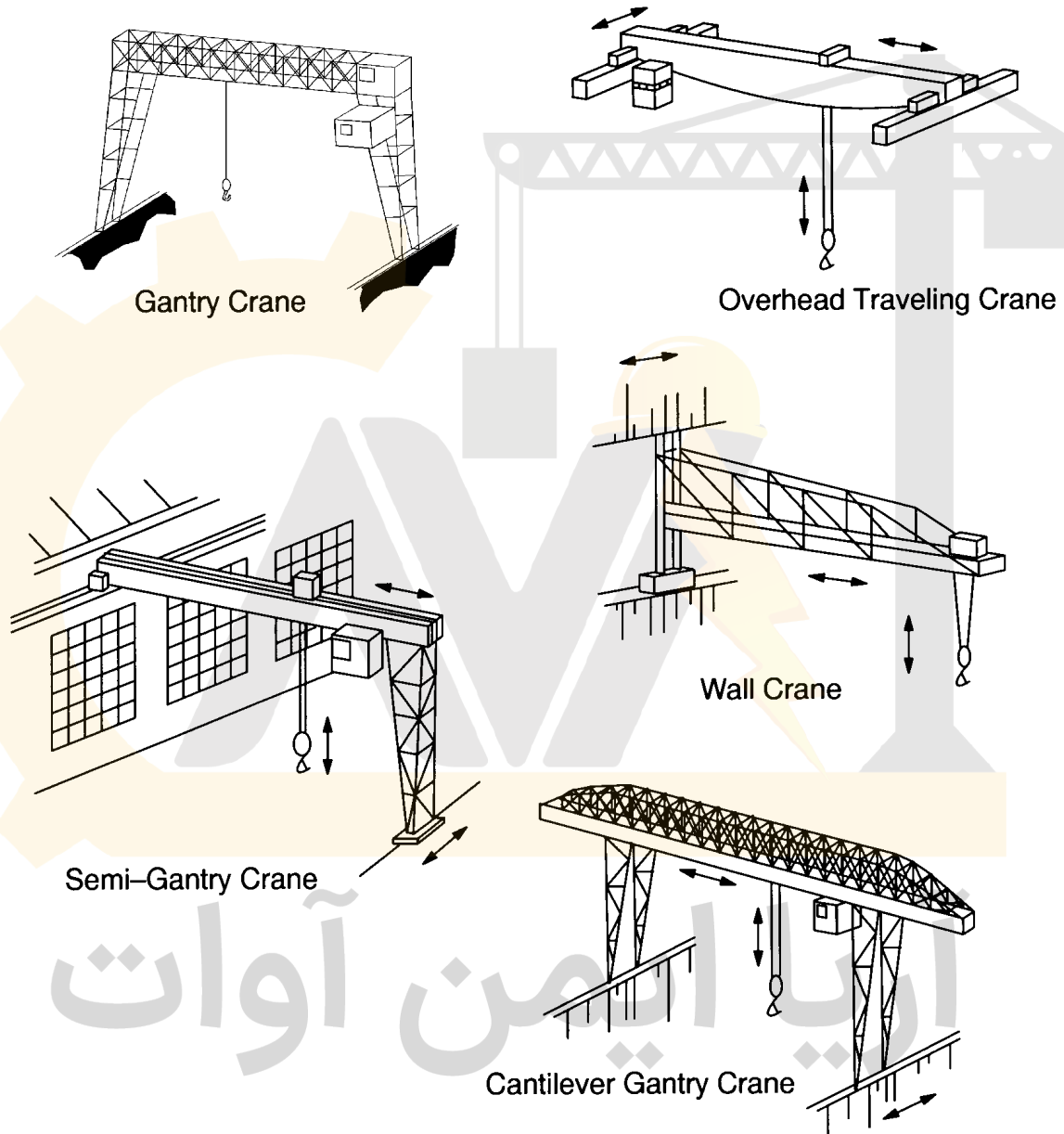

Figure 7-1. Top-running single- or multiple-girder bridge with top-running trolley hoist.

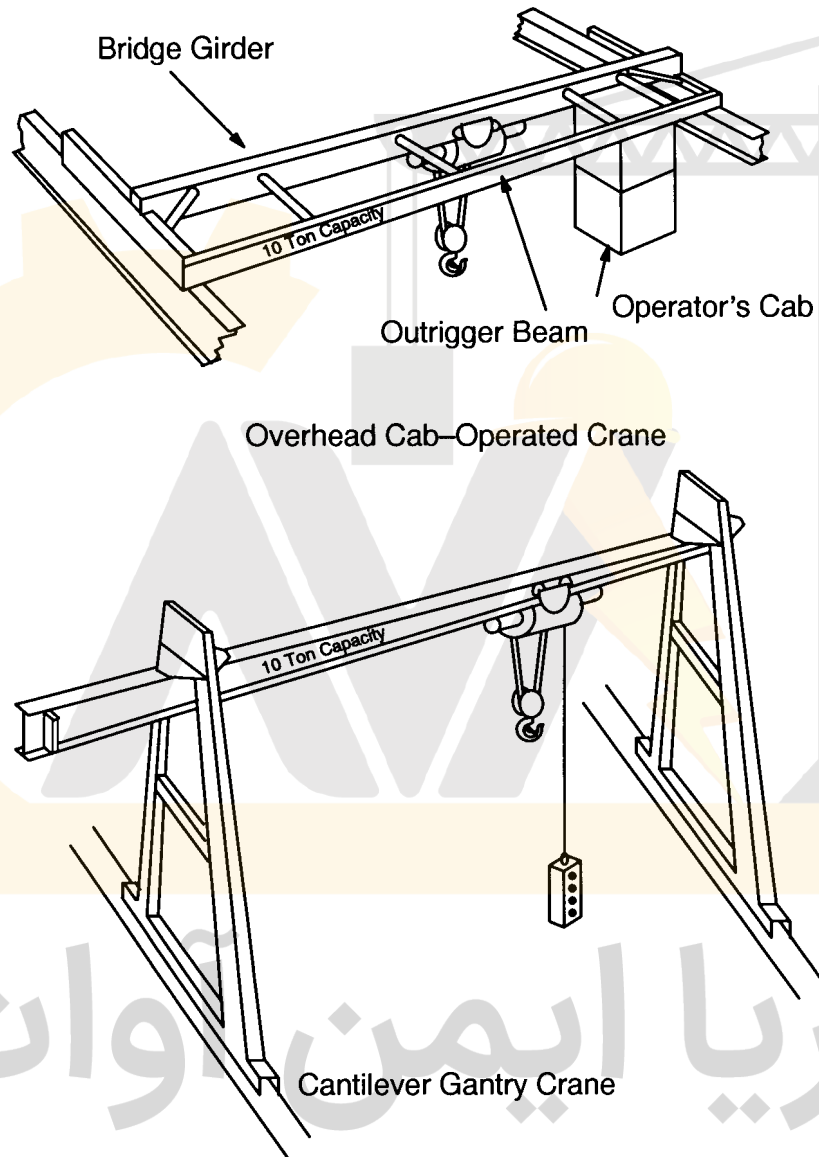
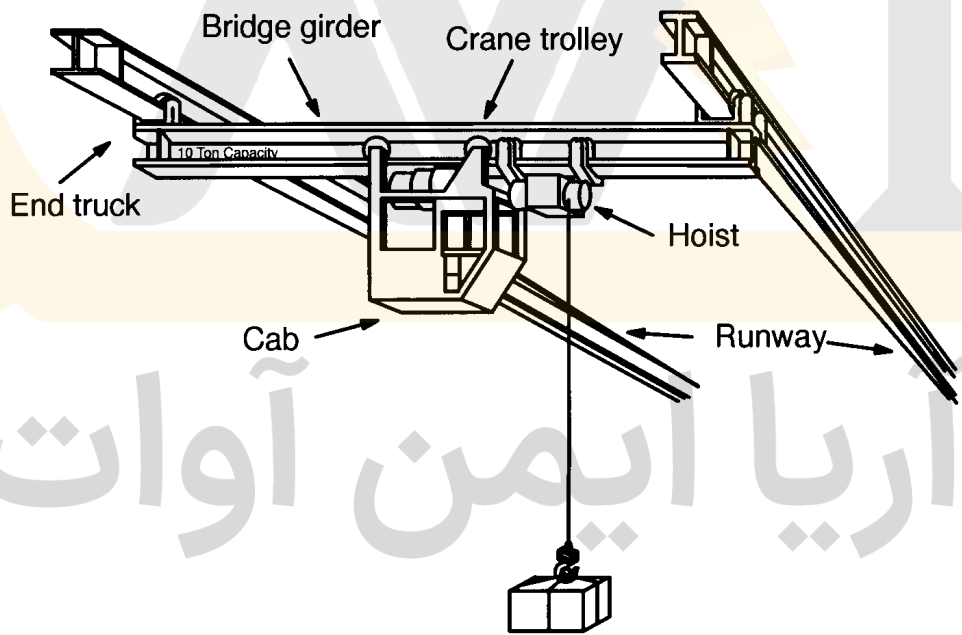
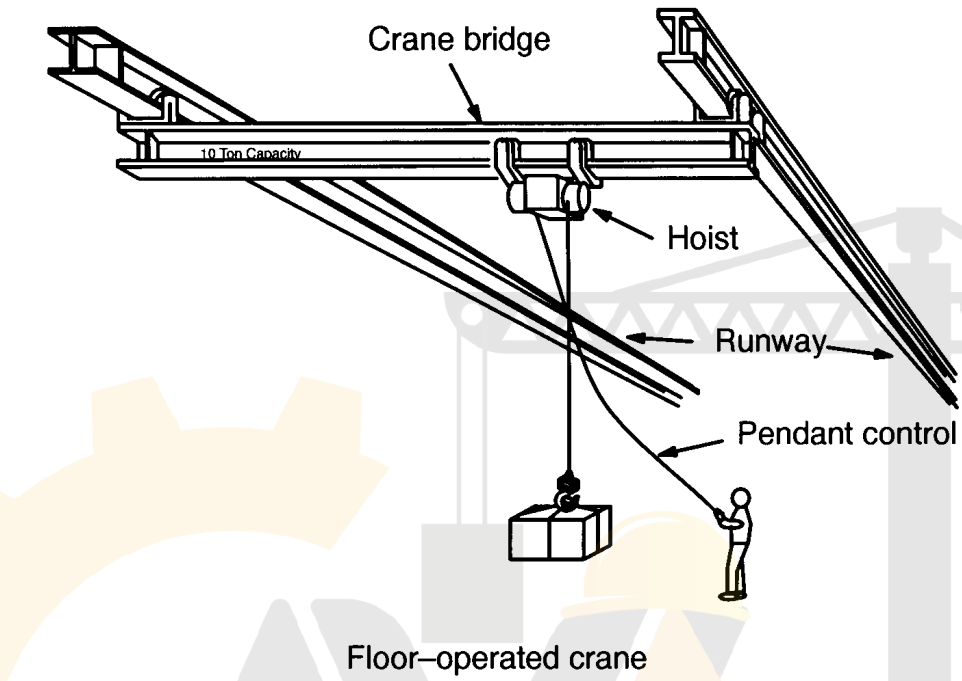

Figure 7-2. Top-running single-girder bridge with underhung trolley hoist.



Cab-operated crane

Figure 7-3. Monorails and underhung cranes.

3. A main-line contactor operated by a switch or push button on the pendant push-button station, the remote-control station, or the pulpit.

7.1.7 Hoist-Limit Switch

- a. The hoisting motion of all cranes shall have an overtravel-limit switch/device in the hoisting direction to stop the hoisting motion.
- b. Lower-travel limit switches/devices should be provided for all hoists where the load block enters pits or hatchways in the floor.

7.1.8 Load Limits

The crane shall not be loaded beyond its rated capacity except for test purposes, as described in Section 7.3.

7.1.9 Maintenance History

The maintenance history of the crane shall be retained throughout its service life.

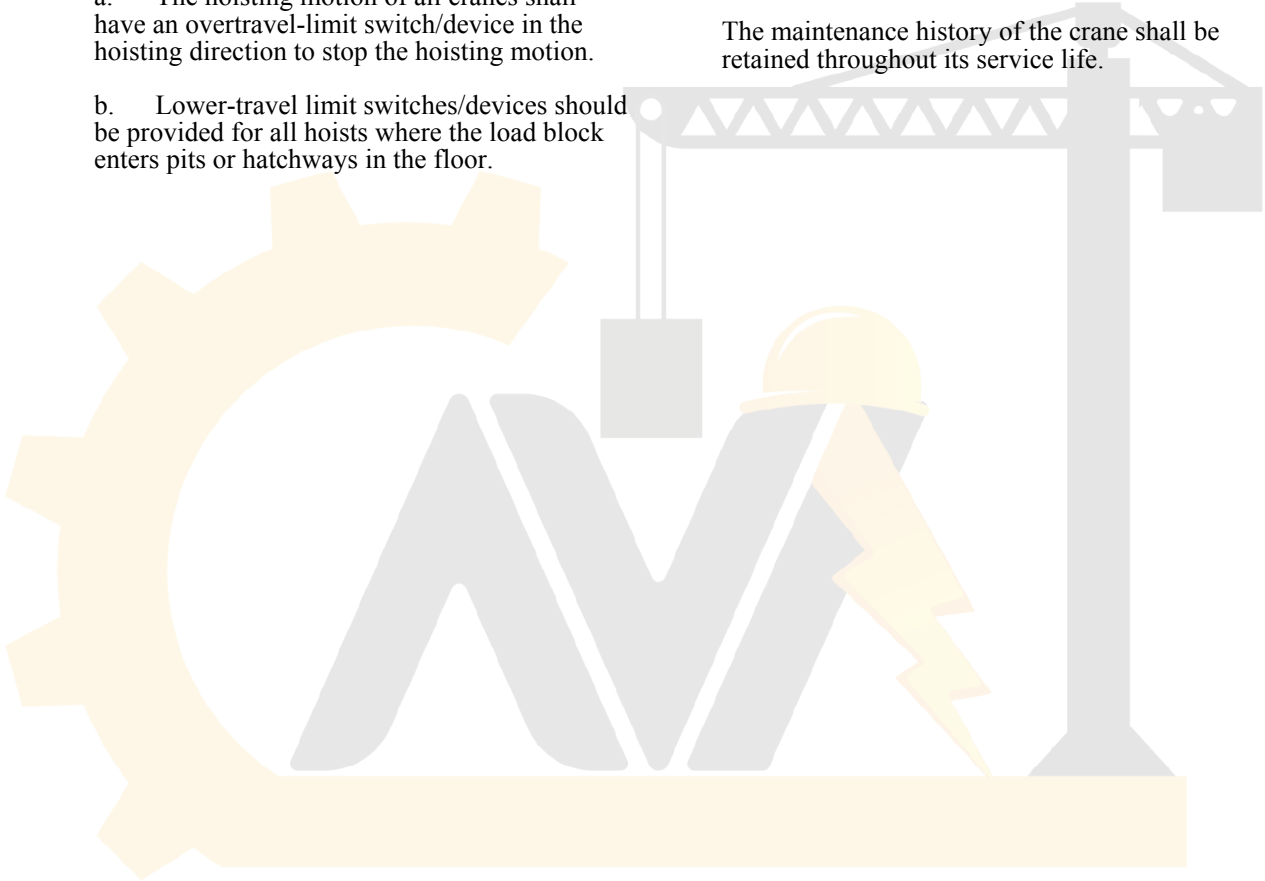

آریا ایمن آوات

7.2 INSPECTIONS

7.2.1 General

There shall be no apparent damage, excessive wear, or deformation of any load-bearing part of the equipment. Brakes shall work satisfactorily and load brakes shall be designed to hold any load up to at least 125 percent of the rated capacity of the equipment without slipping or overheating. All safety devices, load indicators, controls, and other operating parts of the equipment shall be checked during each inspection and shall be in good working order. Parts found to be defective during any inspection or nondestructive examination shall be replaced or repaired as directed by the responsible line manager or that person's designated representative.

7.2.2 Crane Service

Crane service is defined as follows:

- a. Normal service—operating at less than 85 percent of rated load and not more than 10 lift cycles/hr except for isolated instances.
- b. Heavy service—operating at 85 to 100 percent of rated load or in excess of 10 lift cycles/hr as a regular specified procedure.
- c. Severe service—operating at normal or heavy service under abnormal operating conditions (i.e., extreme temperatures, corrosive atmospheres).

7.2.3 Initial Inspection

Prior to their initial use, all new, reinstalled, modified, or repaired cranes shall be inspected by a qualified inspector to ensure compliance with applicable provisions of this chapter. Inspections of repaired and modified cranes may be limited to the provisions affected by the alteration, repair, or modification as determined by a qualified person. Dated and signed inspection reports shall be kept on file and shall be readily available.

7.2.4 Daily Preoperational Check

- a. Operators or other designated personnel shall visually inspect items such as the following each day or prior to first use if the

hoist has not been in regular service (records are not required):

1. Controls and operating mechanisms for proper operation.
 2. Hoist upper-limit switch/device for proper operation at the beginning of each shift or prior to use if hoist has not been in regular service.
 3. Lines, valves, and other parts of air systems for leakage.
 4. Hooks for cracks, deformation and damage from chemicals (see Chapter 13, "Load Hooks," for additional hook requirements).
 5. Hoist rope for significant wear, kinking, crushing, birdcaging, and corrosion. The inspection shall be made by running out as much of the rope or chain as is necessary to visually examine those portions that flex over sheaves, sprockets, and the like, and other areas subject to wear or abrasion.
 6. Hoist chain for nicks, gouges, distortion, wear, and corrosion.
 7. Hook latch, if used, for proper operation.
- b. Operators or other designated personnel shall examine deficiencies and determine whether they constitute a hazard and whether a more detailed inspection is required.

7.2.5 Monthly Rope, Chain, and Hook Inspection

- a. The operator or other designated person shall visually inspect the following items for damage, wear, or other deficiency that might reduce capacity or adversely effect the safety of the crane:
 1. hoist rope or chain
 2. hooks
- b. Lower the hook block to its lowest position and examine for any condition that could result in an appreciable loss of strength.

- c.. Hoist rope for significant wear, kinking, crushing, birdcaging, and corrosion.
- d. Hoist chain for nicks, gouges, distortion, wear, and corrosion.
- e. Hooks for cracks, deformation, damage from chemicals, latch engagement (if provided), and evidence of heat damage.
- f. Signed and dated inspection records shall be kept on file and shall be readily available.
- g. Before the crane is returned to service, correct deficiencies that could reduce its capacity or adversely effect its safety.

7.2.6 Frequent Inspection

- a. Operators or other designated personnel shall visually inspect the crane at the following intervals (records are not required):
 - 1. Normal service—monthly.
 - 2. Heavy service—weekly to monthly.
 - 3. Severe service—daily to weekly.
- b. In addition to the requirements of Section 7.2.4, “Daily Preoperational Check,” these inspections shall include the following:
 - 1. Hoist braking system for proper operation.
 - 2. Hoist rope or chain reeving for compliance with hoist manufacturer's recommendations.
 - 3. Observations during operation.
- c. Operators or other designated personnel shall examine deficiencies and determine whether a more detailed inspection is required.

7.2.7 Periodic Inspection

- a. A qualified inspector shall perform a complete inspection at the following intervals:
 - 1. Normal service—yearly.
 - 2. Heavy service—semiannually.
 - 3. Severe service—quarterly.

- b. The qualified inspector shall examine deficiencies and determine whether they constitute a safety hazard and whether the crane should be removed from service until it is repaired.
- c. Dated and signed inspection records shall be kept on file and shall be readily available.
- d. A sample load test form is included as Exhibit I, which appears at the end of this chapter. This form is intended to be a sample only and is not intended to be mandatory.

7.2.7.1 Cranes

In addition to the requirements of Section 7.2.6, “Frequent Inspections,” periodic inspections shall include the following:

- a. Components for deformation, cracks, or corrosion.
- b. Bolts, rivets, nuts, and pins for being loose or absent.
- c. Check for suspect/counterfeit parts (see Terminology and Definitions, Chapter 1).
- d. Sheaves and drums for cracks or wear.
- e. Parts such as pins, bearings, shafts, gears, rollers, locking and clamping devices, bumpers, and stops for wear, cracks, or distortion.
- f. Brake-system parts, linings, pawls, and latches for excessive wear.
- g. Load, wind, and other indicators over their full range for any significant inaccuracies.
- h. Gasoline, diesel, electric, or other power plants for improper performance or noncompliance with other applicable standards.
- i. Chain-drive sprockets for excessive wear and chains for excessive stretch.
- j. Electrical apparatus for signs of any deterioration of controllers, master switches, contacts, limit switches, and push-button stations (not limited to these items).
- k. Hooks for damage from chemicals, deformation, cracks, or having more than 15 percent in excess of normal throat opening.

DOE-STD-1090-2001

or more than 10 degree twist from the plane of the unbent hook (see Chapter 13 for additional hook requirements).

- l. Hook retaining nuts or collars and pins, welds, or riveting used to secure the retaining members for soundness.
- m. Nondestructive examination of hooks and of welds, bearings, or other suspect load-bearing parts when required by the inspector.
- n. Testing of motion limit devices, which interrupt power or cause a warning to be activated, for proper performance (each motion shall be inched or operated at low speed into the limit device with no load on the crane).
- o. Function labels for legibility.

7.2.7.2 Wire Rope

a. A qualified inspector shall inspect all ropes at least annually. This inspection shall include examination of the entire length of the rope, without detaching it from the hoist drum. More frequent intervals shall be determined by a qualified person and shall be based on such factors as expected rope life as determined by experience on the particular installation or similar installations, severity of environment, percentage of capacity lifts, frequency rates of operation, and exposure to shock loads. The qualified inspector shall carefully note any deterioration such as described below resulting in appreciable loss of original strength and determine whether further use of the rope constitutes an acceptable risk.

- 1. Reduction of rope size below nominal diameter, whether due to loss of core support, internal or external corrosion, or wear of outside wires (see Table 7-1).
- 2. The number and distribution or concentration of broken outside wires.
- 3. Worn outside wires.
- 4. Sections of rope that are normally hidden during inspection or maintenance procedures, such as parts passing over sheaves (these are points most subject to deterioration).
- 5. Corroded or broken wires at end connections.
- 6. Corroded, cracked, bent, worn, or improperly applied end connections.

7. Kinking, crushing, cutting, or unstranding.

b. All rope on cranes that have been idle for 1 month or more due to shutdown or storage shall be inspected before the crane is returned to service. A dated and signed report of the rope inspection, including results, shall be filed.

c. No precise rules can be given for determining the exact time to replace rope because many variables are involved. Safety in this respect depends largely on the use of good judgment by an appointed person in evaluating remaining strength in a used rope, after allowance for deterioration disclosed by inspection. Safety of rope operation depends on this remaining strength.

d. Conditions such as the following shall be sufficient reason for questioning rope safety and considering replacement:

- 1. In running ropes, 12 randomly distributed broken wires in one rope lay, or 4 broken wires in one strand in one rope lay.
- 2. Wear of one-third of the original diameter of outside individual wires.
- 3. Kinking, crushing, birdcaging, or any other damage resulting in distortion of the rope structure.
- 4. Evidence of heat damage from any cause.
- 5. Reductions from nominal diameter greater than those listed in Table 7-1.

e. Replacement rope and connections shall have a strength at least as great as the original rope and connections furnished by the crane manufacturer. Any deviation from the original size, grade, or construction shall be specified by a rope manufacturer, the crane manufacturer, or a qualified person.

f. Never use discarded rope for slings.

7.2.7.3 Chain (Welded Link)

a. Operate the crane under load in raising and lowering directions, and observe the operation of the chain and sprockets. The chain should feed smoothly into and away from the sprockets.

b. If the chain binds, jumps, or is noisy, first see that it is clean and properly lubricated. If

the trouble persists, inspect the chain and mating parts for wear, distortion, or other damage.

Table 7-1. Maximum allowable rope reductions.

Rope diameter	Maximum allowable reduction from Nominal diameter
Up to 5/16 in. (8 mm)	1/64 in. (0.4 mm)
Over 5/16 in. to 1/2 in. (13 mm)	1/32 in. (0.8 mm)
Over 1/2 in. to 3/4 in. (19 mm)	3/64 in. (1.2 mm)
Over 3/4 in. to 1 1/8 in. (29 mm)	1/16 in. (1.6 mm)
Over 1 1/8 in. to 1 1/2 in. (38 mm)	3/32 in. (2.4 mm)

c. The chain should be cleaned before inspection. Examine visually for gouges, nicks, weld spatter, corrosion, and distorted links. Slacken the chain and move adjacent links to one side to inspect for wear at the contact points. If wear is observed or stretching is suspected, the chain should be measured according to the hoist manufacturer's instructions. If instructions are not available, proceed as follows:

1. Select an unworn, unstretched length of the chain (e.g., at the slack end).
2. Suspend the chain vertically under tension and, using a caliper-type gauge, measure the outside length of any convenient number of links approximately 12 in. (305 mm) to 14 in. (356 mm) overall.
3. Measure the same number of links in the used sections and calculate the percentage of increase in length.

d. Conditions such as the following shall be sufficient reason for questioning safety and for considering replacement:

1. If the used chain exceeds a crane manufacturer's recommended length or, in the absence of such a recommendation, the used chain is 1.5 percent longer than the unused

chain for powered hoists or is 2.5 percent longer than the unused chain for hand-operated chain, replace the chain.

2. The existence of gouges, nicks, corrosion, weld spatter, or distorted links.

e. Repairing the load chain by welding or any other means shall not be attempted by anyone other than the chain manufacturer.

f. Replacement chain shall be the same size, grade, and construction as the original chain furnished by the crane manufacturer unless otherwise recommended by the manufacturer due to working conditions.

g. Load-chain links that pass over the load sprocket on edge (alternate to those that lie flat in the pockets) should be installed with the welds away from the center of the sprocket. This precaution is not required on idler sprockets, which change the direction but not the tension in the chain.

h. The chain shall be installed without any twist between the hoist and an anchored end on either the loaded side or the slack side.

i. When a chain is replaced, disassemble and inspect the mating parts (sprockets, guides, stripper) for wear, and replace if necessary.

j. Discarded load chain shall not be used for slings.

7.2.7.4 Chain (Roller)

a. Test the crane under load in raising and lowering directions, observing the operation of the chain and sprockets. If the chain binds, jumps, or is noisy, clean and properly lubricate it. If the trouble persists, inspect the chain and mating parts for wear, distortion, or damage.

b. If wear is observed or stretching is suspected, the chain shall be measured according to the crane manufacturer's instructions. If instructions are not available, proceed as follows:

1. Suspend the hoist in normal position and apply a light load of approximately 50 lb (23 kg).
2. Select a 12-in. (305-mm) section of chain that normally travels over the load sprocket.

DOE-STD-1090-2001

3. Determine elongation by measuring with a caliper from the edge of one chain pin to the corresponding edge of another pin. If elongation exceeds 1/4 in. (6.3 mm) in 12 in. (305 mm) compared to new or unstretched chain values, the chain shall be replaced.

4. Inspect for twist. Replace if the twist in any 5-ft (1.52-m) section exceeds 15 degrees.

5. Check for straightness in a plane perpendicular to the plane of the rollers. Replace if the chain has a bow exceeding 1/4 in. (6.3 mm) in any 5-ft (1.52-m) section.

6. Additional inspection shall be made by removing the chain from the crane and cleaning it thoroughly. Deficiencies such as those listed below shall be carefully examined and a determination shall be made as to whether they constitute a safety hazard:

- i. Pins turned from original position.
- ii. Rollers that do not run freely with light finger pressure.
- iii. Joints that cannot be flexed by easy hand pressure.
- iv. Side plates that are spread open.
- v. Corrosion, pitting, or discoloration.
- vi. Gouges, nicks, or weld spatter.

c. Roller chain shall be replaced if any of the conditions exist as stated in paragraphs 7.2.7.4.b., 1 through 5 above.

d. Deficiencies as stated in paragraph 7.2.7.4.b.6 above are reason for questioning chain safety and considering its replacement.

e. Repairing of roller chain by welding or heating shall not be attempted.

f. Replacement chain shall be the same size, grade, and construction as the original chain furnished by the crane manufacturer unless otherwise recommended by the manufacturer due to working conditions.

g. Roller chain, discarded or new, shall not be used for slings.

7.2.8 Cranes Not in Regular Service

a. Cranes that have been idle for 1 month or more but less than 6 months shall be inspected before being placed in service according to the requirements listed above in Section 7.2.6, "Frequent Inspection."

b. Cranes that have been idle for 6 months or longer shall be inspected before being placed in service according to the requirements listed above in Section 7.2.7, "Periodic Inspection."

آریا ایمن آوات

7.3 TESTING

7.3.1 Operational Tests

a. Prior to initial use, all new, reinstalled, repaired, or modified cranes shall be tested by a designated person to ensure compliance with this chapter, including the following functions:

1. Lifting and lowering.
2. Trolley travel.
3. Bridge travel.
4. Locking, limiting, and indicating devices, if provided.
5. Limit switches/devices.

b. The trip setting of hoist-limit devices shall be determined by tests with an empty hook traveling at increasing speeds up to the maximum speed. The actuating mechanism of the upper-limit device shall be located so that it will trip the device under all conditions and in sufficient time to prevent contact of the hook or load block with any part of the trolley or crane.

7.3.2 Rated Load Test

a. Prior to initial use, all new or reinstalled cranes and cranes in which the load sustaining parts have been altered, modified, repaired, or replaced, or whose rated capacities have been affected shall be tested by or under the direction of a qualified inspector

b. A written report confirming the rated load testing of the crane shall be furnished by the inspector.

c. Test loads shall not be less than 100 percent or more than 125 percent of the rated capacity, unless otherwise recommended by the manufacturer or a qualified person.

d. Testing shall consist of the following operations as minimum requirements:

1. Hoist the test load a sufficient distance to ensure that the load is supported by the crane and held by the hoist brakes. Personnel shall be kept clear of the test load while it is suspended.

2. Transport the test load by means of the trolley for the full length of the bridge.

3. Transport the test load by means of the bridge for the full length of the runway, in one direction with the trolley as close to the extreme right-hand end of the crane as practical, and in the other direction with the trolley as close to the extreme left-hand end of the crane as practical.

4. Lower the test load, stopping by the brakes.

e. The replacement of load chain and rope is specifically excluded from this requirement; however, an operational test of the crane shall be made in accordance with para. 7.3.1.a.1 prior to putting the crane back in service.

f. If wire rope clips or wedge socket end connection are installed during wire rope installation:

1. The crane should be cycled several times with a load equal to or greater than the maximum operational load, normally 100percent of the rated capacity.

2. If wire rope clips are used, then check and retighten nuts to the wire rope clip or wire rope manufacturer's recommended torque value.

3. If a wedge socket is used, then verify that the rope is properly seated.

g. Operational testing of altered, repaired, or modified cranes whose load sustaining parts or rated capacities have not been affected may be limited to the functions affected by the alteration, repair, or modification as determined by a qualified person.

h. ♦ The transporting of test loads as required by paragraph 7.3.2.a above, shall be done insofar as interfering equipment/structures permit and in accordance with recommendations from the manufacturer or a responsible engineering organization. However, test loads should not be carried over critical systems or components.

i. Test weights shall be accurate to within -5 percent, +0 percent of stipulated values.

7.4 MAINTENANCE

7.4.1 Operating Equipment

- a. A preventive maintenance program shall be established and based on the recommendation of the crane manufacturer. If manufacturer's recommendations are no longer available, a qualified person shall establish the program's requirements. Dated records should be kept where readily available to appointed personnel.
- b. Replacement parts shall be at least equal to the original manufacturer's specifications.
- c. All moving parts of the crane for which lubrication is specified shall be regularly lubricated. Check lubricating systems for delivery of lubricant. Follow manufacturer's recommendations as to points and frequency of lubrication, maintenance of lubricant levels, and types of lubricant to be used.
- d. Maintenance personnel shall take the following precautions before performing maintenance on a crane:
 1. Move the crane to a location where it will cause the least interference with other cranes and operations.
 2. Place any attached loads on the ground or floor.
 3. Place all controllers in the OFF position.
 4. Perform a lockout/tagout procedure.
 5. Use warning signs and barriers on the floor beneath the crane where overhead maintenance work creates a hazard.
 6. If the runway remains energized, place stops or signalers full-time at a visual vantage point to observe the approach of active cranes and prohibit contact by the active cranes with the idle crane, with persons performing maintenance, or with the maintenance equipment.

7. Install a guard or barrier between adjacent runways for the length of the established work area to prevent contact between persons performing maintenance and any crane on the adjacent runway.

7.4.2 Wire-Rope Maintenance

Personnel using wire rope shall ensure proper care by doing the following:

- a. Store rope to prevent damage or deterioration.
- b. Unreel or uncoil rope as recommended by the rope manufacturer and with care to avoid kinking or inducing a twist.
- c. Before cutting rope, use some method to prevent unlaying the strands. Heat affected zones of flame cut wire rope shall not be allowed to bear load.
- d. During installation, avoid dragging the rope in dirt or around objects that will scrape, nick, crush, or induce sharp bends in it.
- e. Maintain rope in a well-lubricated condition to reduce internal friction and prevent corrosion. Ensure that lubricant applied as part of a maintenance program is compatible with the original lubricant and is also a type that does not hinder visual inspection. Those sections of rope located over sheaves or otherwise hidden during inspection and maintenance procedures require special attention when the rope is being lubricated.

7.5 OPERATION

- a. The following shall apply to all personnel involved in overhead and gantry crane operation.
- b. At the initial stage of the planning process, an appointed person shall classify each lift into one of the DOE-specified lift categories (ordinary, critical, or preengineered production).

7.5.1 Conduct of Operator

- a. Do not engage in any practice that will divert your attention while operating the crane.
- b. Do not operate cranes without complying with the requirements of Chapter 6. Your immediate supervisor shall participate in this determination.
- c. Operators shall be held directly responsible for the safe operation of their equipment. Whenever there is any question as to the safety of the activity, an operator has the authority to stop and refuse to handle loads until the matter has been resolved by supervisory personnel.
- d. Sound a warning signal (if furnished) during travel, particularly when approaching personnel.
- e. If you find the crane's main or emergency switch open when starting on duty, do not close it until it has been determined that no one is on or close to the crane. If there is a warning sign on the switch, do not remove it unless you placed it there. Do not close the switch until the warning sign has been removed by the person who placed it there.
- f. Before closing the main switch, ensure that all controllers are in the OFF position.
- g. If a power failure occurs during operation, immediately switch all controllers to the OFF position.
- h. Become familiar with your equipment and its proper care. If adjustments or repairs are necessary, or any defects are known, report them promptly to the responsible supervisor. Also, notify the next operator of the defects at shift change.
- i. Contacts with runway stops or other cranes shall be made with extreme caution. If you are ordered to engage with or push other cranes, do this with particular care for the safety of persons on or below the cranes, and only after making

certain that any persons on the other cranes are aware of what action is to be taken.

- j. Secure outdoor cranes before leaving them.
- k. When the wind-indicating alarm is given, anchor the bridge on outside cranes.
- l. Lock and tag the main positive electrical control switch in the OPEN position before any crane maintenance is performed.
- m. Operate all controls before beginning a new shift. If any controls do not operate properly, adjust or repair them before operations begin.
- n. Do not hoist two or more separately rigged loads in one lift, even though the combined load is within the crane's rated capacity.
- o. Ensure that a 10BC or larger fire extinguisher is installed in the cab of cab-operated cranes. The extinguisher shall be maintained in a serviceable condition.
- p. Do not lift, lower, or travel the crane while anyone is on the load or hook.

7.5.2 Hoist-Limit Switch/Device

- a. At the beginning of each work shift, or the first time the crane is used during a shift, test the upper-limit switch/device of each hoist under no load. Exercise extreme care to avoid two-blocking; "inch" the block into the limit switch or run it in at slow speed. If the switch/device does not operate properly, immediately notify the supervisor.
- b. If a lift is in progress during a shift change, this testing requirement is considered to have been satisfied for the completion of that lift. However, test the limit switch again before the next lift.
- c. Do not use the final hoist-limit switch/device that controls the upper limit of travel of the load block as an operating control.

7.5.3 Standard Hand Signals

The standard hand signals for DOE use shall be as specified in the latest edition of the ASME B30 standards for the particular type of crane or hoist being used (see Figure 7-4).



 <p>HOIST. With forearm vertical, forefinger pointing up, move hand in small horizontal circles.</p>	 <p>LOWER. Extend arm downward, forefinger pointing down, and move hand in small horizontal circles.</p>	 <p>BRIDGE. Arm extended forward, hand open and slightly raised, make pushing motion in direction of travel.</p>
 <p>TROLLEY TRAVEL. Palm up, finger closed, thumb pointing in direction of motion, jerk hand horizontally.</p>	 <p>STOP. Extend arm, palm down, hold position rigidly.</p>	 <p>EMERGENCY STOP. Extend arm, palm down, moving hand rapidly right and left.</p>
 <p>MULTIPLE TROLLEYS. Hold up one finger for block marked "1" and two fingers for block marked "2." Regular signals follow.</p>	 <p>MOVE SLOWLY. Use one hand to give any motion signal and place other hand motionless above hand giving the motion signal. (Hoist slowly shown as example.)</p>	 <p>MAGNET IS DISCONNECTED. Crane operator spreads both hands apart, palms up.</p>

Figure 7-4. Standard hand signals for controlling overhead crane operation.

7.5.4 Identification of Signalers

- a. All personnel acting as signalers during crane operations shall be clearly identified to the crane operator by using the following (one or more, as required by the responsible manager): orange hardhat, orange gloves, and orange vest. This requirement may be waived by the responsible manager when the lift is very closely controlled or personnel are required to wear special clothing for protection from a hazardous environment.
- b. In those cases where the crane operator cannot see the signaler, a second person (relay signaler) shall be stationed where he or she can see both the signaler and the crane operator and signals can be relayed to the operator. The relay signaler shall also be clearly identified by the items described in the previous paragraph.
- c. Where voice (direct or two-way radio) communication is used, the signaler shall communicate directly with the operator, not through a third person.
- d. The operator shall obey signals only from the designated signaler. Obey a STOP signal no matter who gives it.

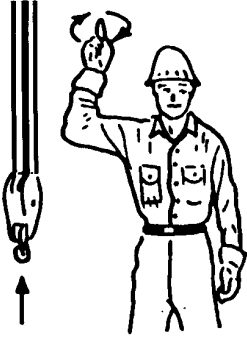
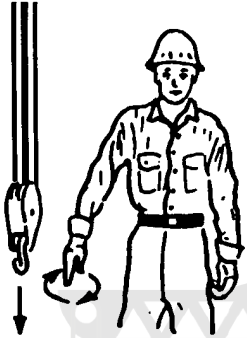
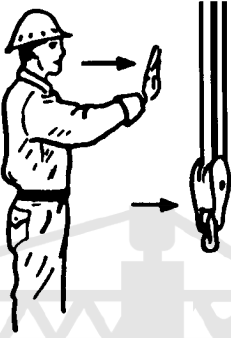
7.5.5 Size of Load

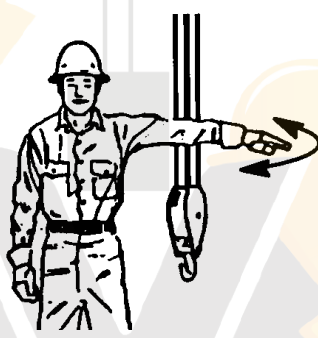
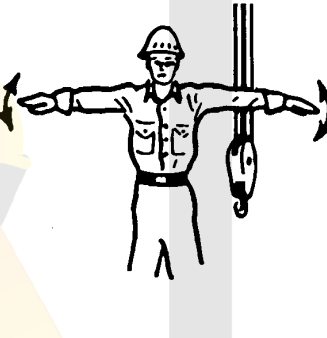
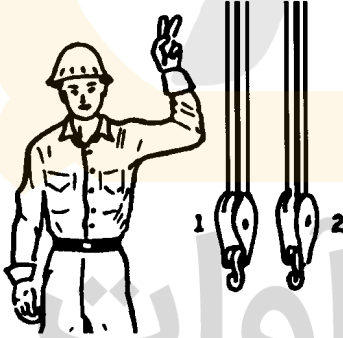
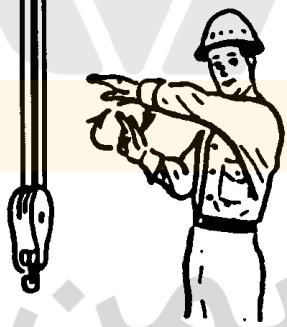
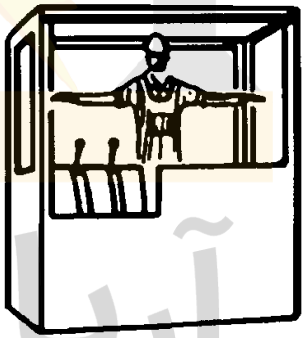
- a. The weight of the load shall be determined prior to making the lift.
- b. The crane and rigging equipment shall not be loaded beyond its rated capacity, except for authorized testing described in Section 7.3.

7.5.6 Attaching the Load

- a. Ensure that the hoist rope is free from kinks or twists. Do not wrap the hoist rope around the load.
- b. Ensure the load is attached to the load-block hook by means of slings or other approved devices.
- c. Take care to make certain that the sling clears all obstacles.

7.5.7 Moving the Load

- a. The person appointed to direct the lift shall see that the load is well secured and properly balanced in the sling or lifting device before it is lifted more than a few inches.
- b. Before starting to hoist, note the following conditions:
 1. Hoist rope shall not be kinked.
 2. Multiple-part lines shall not be twisted around each other.
 3. The hook shall be positioned above the center of gravity of the load in such a manner as to minimize swinging when the load is lifted.
 4. If there is a slack-rope condition, it should be determined that the rope is properly seated on the drum and in the sheaves.
 5. All personnel including the qualified rigger shall be clear of the load.
- c. During hoisting, take care to ensure that:
 1. The load is lifted slowly until it clears the ground or other support to minimize swinging.
 2. There is no sudden acceleration or deceleration of the moving load.
 3. The load does not contact any obstructions. A “dry run” shall be conducted in areas where clearance is limited.
- d. Cranes shall not be used for side pulls except when specifically authorized by an appointed person who has determined that the stability of the crane is not endangered and that load-bearing parts of the crane will not be overstressed.
- e. ♦ Avoid carrying loads above people.
- f. Each time a load approaching the rated capacity is handled, test the hoist brakes by raising the load a few inches and applying the brakes. Any slippage or downward motion is unacceptable.

DOE-STD-1090-2001

g. Do not lower the hook below the point where less than two full wraps of rope remain on the hoisting drum.

h. When the load or hook approaches personnel, sound the warning signal.

i. Tag lines should be used as required to guide, snub, or otherwise control the load.

j. Place any attached load on the ground or floor, place controls in the OFF position, and turn off the power source before leaving the crane unattended, unless required to do otherwise by an approved emergency procedure.

k. Work on suspended loads is prohibited under normal conditions. If the responsible manager decides that it is necessary to work on a suspended load, guidelines for safe operation shall be established through consultation with the appropriate safety organization. Suspended loads that must be worked on shall be secured against unwanted movement.

7.5.8 Ordinary Lifts

a. The requirements of all preceding paragraphs in Section 7.5, "Operation," also shall apply to ordinary lifts.

b. An appointed person shall classify each lift into one of the DOE categories (ordinary, critical, or preengineered production) before the lift is planned.

c. Hoisting and rigging operations for ordinary lifts require a designated leader who shall be present at the lift site during the entire lifting operation. If the lift is being made by only one person, that person assumes all responsibilities of the designated leader.

d. Leadership designation may be by written instructions, specific verbal instructions for the particular job, or clearly defined responsibilities within the crew's organizational structure.

e. The designated leader's responsibility shall include the following:

1. Ensure that personnel involved understand how the lift is to be made.

2. Ensure that the weight of the load is determined, that proper equipment and accessories are selected, and that rated capacity is not exceeded.

3. Survey the lift site for hazardous/unsafe conditions.

4. Ensure that equipment is properly set up and positioned.

5. Ensure that a signaler is assigned, if required, and is identified to the operator.

6. Direct the lifting operation to ensure that the job is done safely and efficiently.

7. Stop the job when any potentially unsafe condition is recognized.

8. Direct operations if an accident or injury occurs.

f. The operator, or a designated person, shall ensure that the crane is still within the inspection interval.

g. The operator, or a designated person, shall visually examine the crane in accordance with Section 7.2.4.

7.5.9 Critical Lifts

See Chapter 2, "Critical Lifts," for critical-lift requirements.

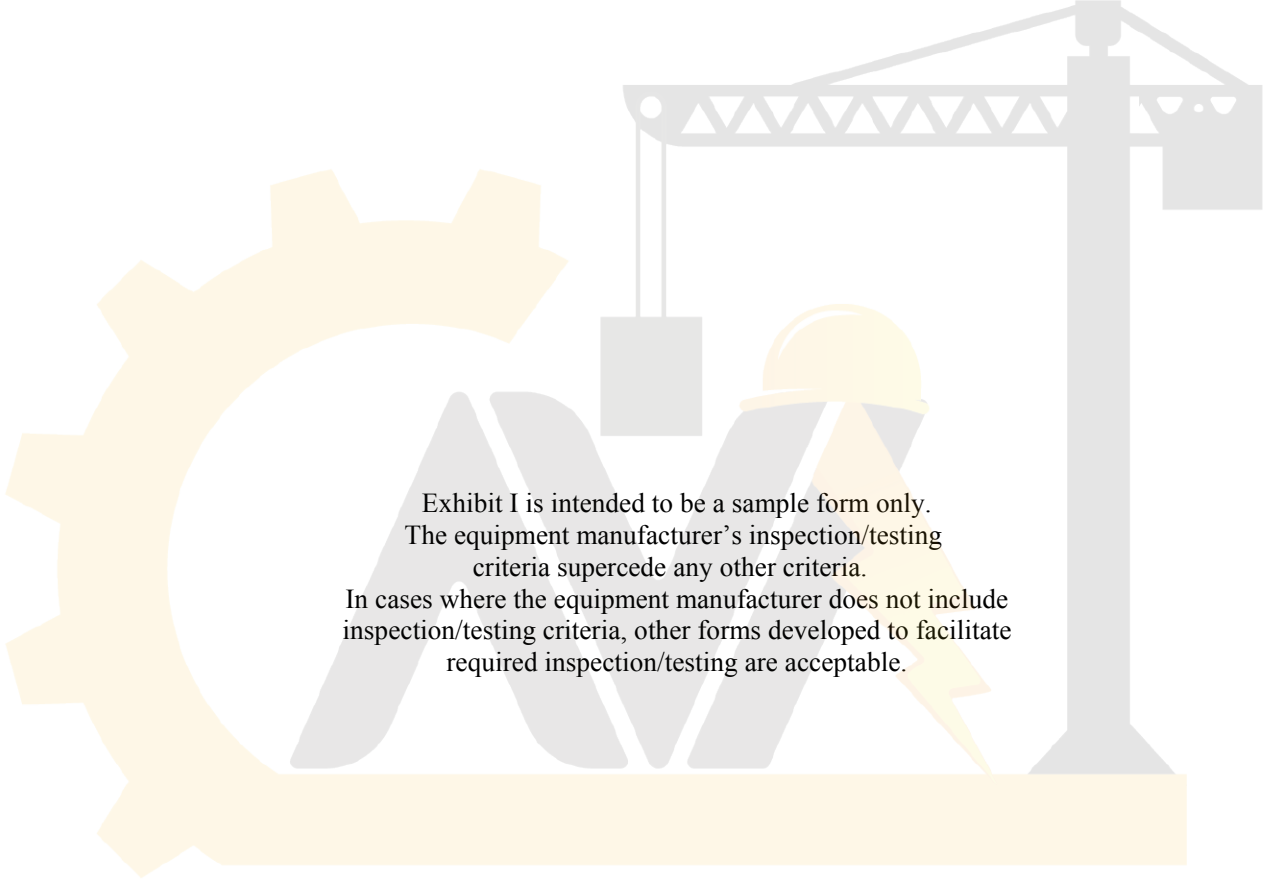

Exhibit I is intended to be a sample form only.
The equipment manufacturer's inspection/testing
criteria supercede any other criteria.
In cases where the equipment manufacturer does not include
inspection/testing criteria, other forms developed to facilitate
required inspection/testing are acceptable.

آریا ایمن آوات

DOE-STD-1090-2001

EXHIBIT I
(SAMPLE FORM)

BRIDGE, WALL, GANTRY CRANE LOAD TEST FORM

EQUIPMENT NO. _____ MAKE _____ RATED CAPACITY _____ DATE _____

LOAD TEST INSPECTION REPORT

The following checklist identifies the items to be inspected prior to the load test. Any unusual conditions observed during the inspection should be noted in the Remarks section.

- NOTES:**
1. Craftsmen shall initial and date all tests, work, and inspections completed below.
 2. Qualified inspector shall verify all steps prior to load test.

NO.	CRANE ITEM	DEFECT	OK	NA	NO.	CRANE ITEM	DEFECT	OK	NA
1	Load Hook & Blocks				18	Controllers			
2	Wire Rope and End Connections				19	Relays and Coils			
3	Handrails, Walkways, and Ladders				20	Conductors and Collectors			
4	Bridge and Trucks				21	Panel Wiring			
5	Bridge Wheels and Bearings				22	Resistors			
6	Trolley and Rails				23	Bypass Switches			
7	Trolley Wheels and Bearings				24	Limit Switches			
8	Crane Alignment				25	Contactors (Electrical)			
9	Runway Rail & Clamps				26	Motors			
10	Bumpers/Endstops				27	Gauges			
11	Brake System				28	Lighting System			
12	Drive Shafts, Gears, Couplings & Bearings				29	Heater and Switches			
13	Pawls, Ratchets, Spuds, & Windlocks				30	Operator's Cab			
14	Sheaves				31	Safety			
15	Warning Devices				32	Chain and Sprockets			
16	Capacity Signs				33	Structural			
17	Main Disconnect				34	Wire Rope Drum and Machinery Foundation			

REMARKS (Unusual conditions—noises, structural cracks, misalignment, etc.)

BRIDGE CRANE AND FOLLOW UP CHECKS

- NOTES:**
1. Craftsmen shall initial all steps completed below.
 2. Qualified inspector shall verify all steps below.
 3. Load test shall be performed on all new, repaired, or modified cranes prior to initial use.
 4. Load test crane at 125% of rated capacity. In no case shall the load test exceed 125% of rated capacity. Test weights shall be accurate to -5%, + 0% of stipulated values.

INITIAL

- | | |
|-------|--|
| _____ | 1. Set crane up for load test and qualified inspector verify inspection is complete prior to load test. |
| _____ | 2. The trip setting of hoist-limit devices shall be determined by tests, with an empty hook traveling at increasing speeds up to the maximum speed. The actuating mechanism of the limit device shall be located so that it will trip the device under all conditions and in sufficient time to prevent contact of the hook or load block with any part of the trolley or crane. |
| _____ | 3. Rig test weight to hoist hook using appropriate slings. |
| _____ | 4. Hoist the test load a sufficient distance to ensure that the load is supported by the crane and held by the hoist brakes. |
| _____ | 5. Transport the test load by means of the trolley for the full length of the bridge. Ensure during operation that the trolley runs true on the bridge. Check trolley motor, brake, and gear case for overheating. |
| _____ | 6. Transport the test load by means of the bridge for the full length of the runway, first in one direction with the trolley as close to the extreme right-hand end of the crane as practical and next in the other direction with the trolley as close to the extreme left-hand end of the crane as practical. Ensure that the bridge runs true on the runway rails and that no undue girder deflection occurs. Check for bridge motor, brake, and gear-case overheating. |
| _____ | 7. Move the test load back into the original position and lower the test load, stopping by the brakes. Hold the load for 10 min or the time required to check all primary load-bearing parts while under load for slippage, damage, or permanent deformation. |
| _____ | 8. Slowly lower the test load to the floor. |
| _____ | 9. At the completion of the load test, visually inspect the following load-bearing parts for signs of wear, deformation, and deterioration: |

DEFECTIVE/OK/NA

- _____ a. Bridge track
- _____ b. Bridge wheels
- _____ c. Trolley track
- _____ d. Trolley wheels
- _____ e. Gears
- _____ f. Magnetic brakes
- _____ g. Blocks.

Visually inspect rope in accordance with Chapter 11, "Wire Rope and Slings."

- _____ a. Rope diameter: (Previous) _____ (Present) _____
- _____ b. Wear
- _____ c. Kinks
- _____ d. Broken wires
- _____ e. Other signs of deterioration.

Visually inspect the rope drum for:

- _____ a. Wear
- _____ b. Deformation
- _____ c. Deterioration.

INITIAL

- _____ 10. Qualified inspector shall perform nondestructive tests on hook by visual examination, liquid penetrant examination, or magnetic-particle examination. Acceptance: No cracks, linear indications, laps, or seams.

Hooks with more than 15% normal (new hook) throat opening shall be replaced. Hooks with more than 10 degree twist from the normal (new hook) plane of the hook shall be replaced. Hooks having more than 10% wear in the throat section or 5% elongation of the shank shall be replaced. Lubricate hook bearing and latch pin as applicable.

Establish three marks, A, B, and C, with a center punch. For ease in measuring, set distances on an even number of inches.

BEFORE LOAD TEST

Length AB _____ in.

Length BC _____ in.

AFTER LOAD TEST

Length AB _____ in.

Length BC _____ in.

Check for:

1. Wear and deformation
2. Cracks and twisting
3. Signs of opening between Point A and Point B

Load Test Inspection Date _____

Qualified Inspector _____

Operated By _____

Actual Load Test _____ lb

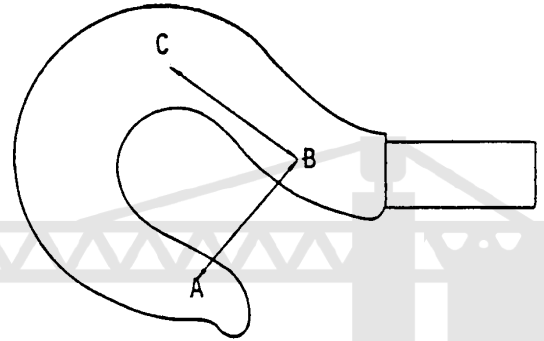

آریا ایمن آوات

**EXHIBIT II
(SAMPLE FORM)**

OVERHEAD CRANE PRE-OPERATIONAL CHECKLIST
(Records Are Not Required)

CRANE NO.	CAPACITY	TYPE	LOCATION	SHIFT 1 2 3
OPERATORS NAME:		INSTRUCTIONS: Check all items. Inspect and indicate as: Satisfactory - S, Unsatisfactory - U, or Not Applicable - NA		
1. WALK AROUND INSPECTION		S /U/ NA	2. MACHINERY INSPECTION	
a	Foundations		a	Holding Brake *
b	Access		b	Load Control Brake
c	Secured Items		c	Covers Secured
d	Walkways/Handrails		d	Upper Sheaves *
e	Bridge, Drive Motor		e	Wire Rope *
f	Bridge Brake *		f	Hooks: Cracks, Wear, Deformation, * Throat Opening, Latch Operation
g	Hydraulics		g	Fluid Leaks
h	Couplers/Connection Rods		h	Batteries
i	End Trucks *		i	Electric Motors
j	Rail Sweeps		j	Electric Panels
k	Windlocks/Chock/Stops		k	Runway/Bridge Conductors
l	Housekeeping		l	Runway/Bridge Collectors
			m	Electrical Guards
			n	Festoon System
			o	Warning Tags/Signs
			p	Exposed Electrical Hazards
			q	Trolley Stops *

DOE-STD-1090-2001

EXHIBIT II (continued)

OVERHEAD CRANE PRE-OPERATIONAL CHECKLIST
(Records Are Not Required)

3. OPERATOR CAB INSPECTION		S/U/ NA	4. OPERATION INSPECTION		S/U/ NA
a	Housekeeping		a	Power Supply Relay *	
b	Warning Tags *		b	Manual Reset	
c	Cab Door(s)		c	Stop Button/Control *	
d	Fire Extinguisher		d	Pendant Buttons *	
e	Controls Identification		e	Upper Limit/Main *	
f	Electrical Enclosures		f	Upper Limit/Auxiliary *	
g	Pendant Strain Relief		g	Lower Limit/Main	
h	Visibility/Windows		h	Lower Limit/Auxiliary	
i	Safety Devices		i	Bridge Controls *	
j	Warning/Indicator Light		j	Bridge Brake *	
k	Alarms		k	Trolley Control *	
			l	Main Hook *	
			m	Auxiliary Hook *	
			n	Work Area	
			o	Runway Stops *	
			p	Travel Limit Relays *	
<p>INSTRUCTIONS: Inspect all applicable items each shift of operation. Suspend all operations immediately when observing an unsatisfactory condition for asterisked (*) items. In addition, suspend operation when any unsafe condition is observed and immediately notify supervisor. Other conditions not affecting safety shall be noted under "Remarks" and reported to supervisor.</p>					
<p>REMARKS:</p>					

DOE-STD-1090-2001

EXHIBIT III
(SAMPLE FORM)

PERIODIC CRANE INSPECTION REPORT

MECHANICAL ITEMS						
MAKE:		CAPACITY:		LOCATION:		
STATUS CODE: SR - Should be Replaced NR - Needs Repair R - Repaired SN - See Notes N/A - Not Applicable						
ITEM	OK	CODE		ITEM	OK	CODE
Bridge				- Cam Followers/Guide*		
- Alignment				- Runway End-Stops		
- Girders (camber)				- Railway Sweeps / Safety Lugs		
- Rails				- Energy Absorbing Bumpers		
- Walks, Ladders, Railings				Mono Rail		
- Trucks to Girder Connection				- Girders		
- Trucks				- Girder Supports		
- Wheels, Driver *				- Sway Braces		
- Wheels, Idler *				Misc.		
- Wheels, Bearings *				- Clearances Overhead (3")		
- Axles & Coupling *				- Clearances Lateral (2")		
- Squaring Shaft				Rated Load Markings:		
- Squaring Shaft Bearings				- Each Side of Crane Bridge		
- Squaring Shaft Couplings				- Each Hoist/Load Block		
- Motor Coupling *				Trolley Drive		
- Gear Reducer				- Wheels, Driver *		
- Gear Reducer Oil Seals				- Wheels, Idler *		
- Axle Pinion				- Wheels Bearings *		
- Axle Gear				- Axles & Couplings		
- Runway Alignment				- Motor Couplings *		

DOE-STD-1090-2001

EXHIBIT III (continued)
(SAMPLE FORM)

ITEM	OK	CODE	ITEM	OK	CODE
- Gear Reducer			- Drum Grooving		
- Gear Reducer Oil Seals			- Drum Shafts		
- Axle Pinion			- Motor Pinion		
- Axle Gear			- Motor Gear		
- Cam Followers/Guides *			- Intermediate Pinion		
- Energy Absorbing Bumpers			- Intermediate Gear		
- End Stops			- Drum Pinion		
Hoist (M - Main) (A - Auxiliary)			- Drum Gear		
- Hook			- Hoist Case Bearing		
- Hook Bearing			- Mechanical Load Brake*		
- Sheaves *			- Friction Disc*		
- Sheave Bearings *			- Pawl *		
- Equalizer Sheave *			- Pawl Shifter		
- Rope/Chain			- Ratchet or Band		
- Rope Anchors			- Motor Coupling *		
			- Hoist Case Coupling *		
Needs Immediate Action:					
آریا ایمن آوات					
Notes:					
Circle One: PASS FAIL					
INSPECTOR (print): _____ SIGNATURE: _____ DATE: _____					

Items with * to be inspected prior to use as part of the Pre-Operational check and lubricated as needed. All other items to be inspected and lubricated annually.

**EXHIBIT IV
(SAMPLE FORM)**

OVERHEAD CRANE PERIODIC INSPECTION REPORT

ELECTRICAL ITEMS						
MAKE:		CAPACITY:		LOCATION:		
STATUS CODE: SR - Should be Replaced NR - Needs Repair R - Repaired SN - See Notes N/A - Not Applicable						
ITEM	OK	CODE		ITEM	OK	CODE
Brakes				- Trolley Motor rings		
- M.H. Brake Shoes & Disc				- M.H. Motor Bearings		
- M.H. Brake Linings *				- M.H. Motor Brushes *		
- M.H. Brake Linkage				- M.H. Motor Rings		
- M.H. Brake Coil				Misc		
- A.H. Brake Shoes & Discs						
- A.H. Brake Lining *						
- A.H. Brake Linkage						
- A.H. Brake Coil						
- Trolley Brake Shoes & Disc						
- Trolley Brake Lining *				Controls		
- Trolley Brake Linkage				- For Magnetic Control		
- Trolley Brake Coils				- Master Switches		
- Hydraulic Brake Bleeder *				- Push-button Station		
Motors				- M.H. Contactors		
- Bridge Motor Bearings				- A.H. Contactors		
- Bridge Motor Brushes *				- Trolley Contactors		
- Bridge Motor Rings				- Bridge Contactors		
- Trolley Motor Bearings				- M.H. Overhead Relays		
- Trolley Motor Brushes *				- A.H. Overhead Relays		

DOE-STD-1090-2001

EXHIBIT IV (continued)
(SAMPLE FORM)

ITEM	OK	CODE	ITEM	OK	CODE
Controls (continued)			Resistors		
- Trolley Overhead Relays			- M.H. Resistors		
- Bridge Overhead Relays			- A.H. Resistors		
- M.H. Limit Switch Contacts			- Trolley Resistors		
- A.H. Limit Switch Contacts			- Bridge Resistors		
For Manual Drum Control			Mainline		
- M.H. Finger Tips*			- Mainline Switch		
- M.H. Segments *			- Fuses (Sizes)		
- A.H. Finger Tips *			- Power Wiring		
- A.H. Segments *			- Control Wiring		
- Trolley Finger Tips *			- Trolley Collectors *		
- Trolley Segments *			- Runway Collectors *		
- Bridge Finger Tips *			- Bridge Conductors		
- Bridge Segments *			- Runway Conductors		
Needs Immediate Action:					
Notes:					
Circle One: PASS FAIL					
INSPECTOR (Print): _____ SIGNATURE: _____ DATE: _____					

Items with * to be inspected prior to use as part of the Pre-operational check and lubricated as needed.
All other items to be inspected and adjusted annually.

CHAPTER 9

MOBILE CRANES

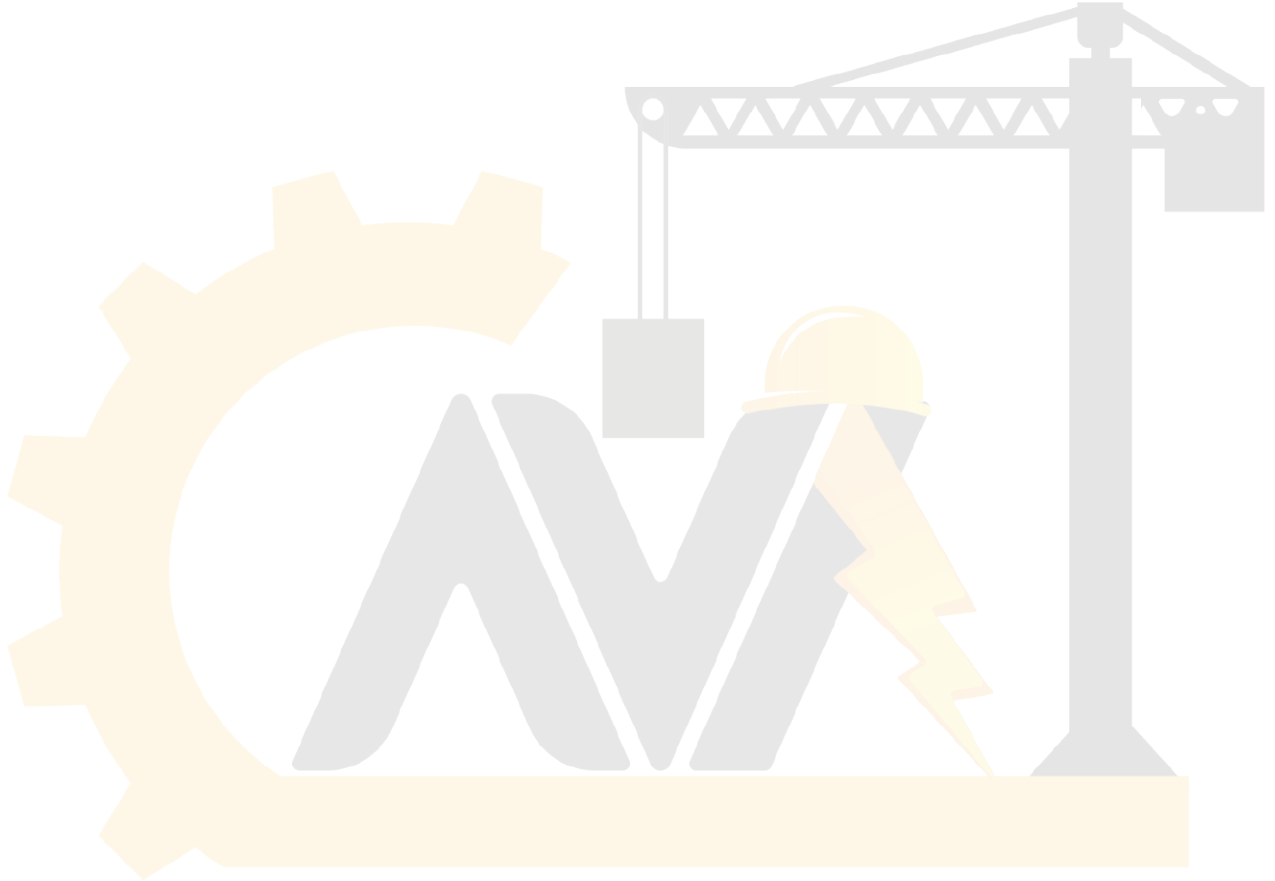

آریا ایمن آوات

9.2 INSPECTIONS

9.2.1 General

Equipment shall operate with a smooth, regular motion without any hesitation, abnormal vibration, binding, gross shimmy, or irregularity. There shall be no apparent damage, excessive wear, or deformation of any load-bearing part of the equipment. All safety devices, load indicators, boom angle and radius indicators, controls, and other operating parts of the equipment shall be checked during each inspection and shall be in good working order.

9.2.2 Initial Inspection

Prior to initial use, all new or modified cranes shall be inspected as required in Section 9.2.6, "Periodic Inspection," by a qualified inspector to ensure compliance with the applicable provisions of this chapter. Dated and signed inspection reports shall be kept on file and shall be readily available.

9.2.3 Daily Preoperational Check

- a. Operators or other designated personnel shall visually inspect items such as the following each day or prior to use if the crane has not been in regular service (records are not required):
1. All control mechanisms for maladjustment interfering with proper operation.
 2. Crane hooks and latches for deformation, cracks, and wear.
 3. Hydraulic systems for proper oil level.
 4. Lines, tanks, valves, pumps, and other parts of air or hydraulic systems for leakage.
 5. Hoist ropes for kinking, crushing, birdcaging, and corrosion.
 6. Anti-two-block, two-block warning, and two-block damage prevention systems for proper operation.
 7. Booms for damage or deformation of structural components.
- b. Operators or other designated personnel shall examine deficiencies and determine

whether they constitute a safety hazard.

9.2.4 Monthly Inspection

- a. The operator or other designated person shall visually inspect the following items for damage, wear, or other deficiency that might reduce capacity or adversely effect the safety of the crane:
1. Critical items such as brakes and crane hooks.
 2. Hoist ropes.
- b. Lower the hook block to its lowest position and examine for any condition that could result in an appreciable loss of strength.
- c. Hooks for cracks, deformation, damage from chemicals, latch engagement (if provided), and evidence of heat damage.
- d. A hoist rope with any of the conditions noted in the replacement criteria in Section 9.2.6 shall be removed from service and replaced.
- e. Signed and dated inspection records shall be kept on file and shall be readily available.
- f. Before the crane is returned to service, correct deficiencies that could reduce its capacity or adversely effect its safety.

9.2.5 Frequent Inspection

- a. Operators or other designated personnel shall visually inspect the crane at daily to monthly intervals (records are not required).
- b. These inspections shall, in addition to the requirements of Section 9.2.3, "Preoperational Check," include the following:
1. All control mechanisms for maladjustment, excessive wear, and contamination by lubricants or other foreign matter that could interfere with proper operation.
 2. All safety devices for malfunction.
 3. Rope reeving for noncompliance with crane manufacturer's recommendations.
 4. Electrical apparatus for malfunctioning, signs of excessive deterioration, and accumulation of dirt or moisture.

5. Tires for recommended inflation pressure.

6. Boom sections for damaged, deformed, or missing structural members or parts.

c. Operators or other designated personnel shall examine deficiencies and determine whether a more detailed inspection is required.

9.2.6 Periodic Inspection

a. Complete inspections of the crane shall be performed by a qualified inspector at 1- to 12-month intervals, depending on the crane's activity, severity of service, and environment.

b. The qualified inspector shall examine deficiencies and determine whether they constitute a hazard.

c. Dated and signed inspection records shall be kept on file and shall be readily available.

d. A sample load test form is included as Exhibit I, which appears at the end of this chapter. This form is intended to be a sample only and is not intended to be mandatory.

e. These inspections shall, in addition to the requirements of Sections 9.2.4, "Monthly Inspection," and 9.2.5, "Frequent Inspection," include the following.

9.2.6.1 Cranes

Inspect for:

a. Deformed, cracked, or corroded members in the crane structure and entire boom.

b. Bolts, rivets, nuts, and pins for being loose or absent

c. Check for suspect/counterfeit parts (see Terminology and Definitions, Chapter 1).

d. Cracked or worn sheaves and drums.

e. Hooks damaged from chemicals, deformation, or cracks, or having more than 15 percent in excess of normal throat opening or more than 10 degree twist from the plane of the unbent hook (dye-penetrant, magnetic-particle, or other suitable crack-detecting inspections should be performed at least once a year; see Chapter 13, "Load Hooks," for additional hook requirements).

f. Worn, cracked, or distorted parts such as pins, bearings, shafts, gears, rollers, and locking devices.

g. Excessive wear on brake and clutch system parts, linings, pawls, and ratchets.

h. Load, boom angle, and other operating aids over their full ranges for any significant inaccuracies (if calibration is required, it shall be done by a qualified person).

i. Gasoline, diesel, electrical, or other power plants for improper performance or noncompliance with safety requirements.

j. Radiators and oil coolers, for leakage, improper performance, or blockage of air passages.

k. Excessive wear of chain drive sprockets and excessive chain stretch.

l. Steering, braking, and locking devices, for malfunctioning.

m. Excessively worn or damaged tires.

n. Rust on piston rods and control valves when crane has been idle.

9.2.6.2 Hydraulic and Pneumatic Hose, Fittings, and Tubing

Inspect for:

a. Evidence of leakage at the surface of the flexible hose or its junction with the metal couplings.

b. Blistering or abnormal deformation of the outer covering of the hydraulic or pneumatic hose.

c. Leakage at threaded or clamped joints that cannot be eliminated by normal tightening or recommended procedures.

d. Evidence of excessive abrasion or scrubbing on the outer surface of a hose, rigid tube, or fitting (means shall be taken to eliminate the interface of elements in contact or to otherwise protect the components).

9.2.6.3 Hydraulic and Pneumatic Pumps and Motors

Inspect for:

a. Loose bolts or fasteners.

b. Leaks at joints between sections.

c. Shaft seal leaks.

d. Unusual noises or vibration.

- e. Loss of operating speed.
- f. Excessive heating of the fluid.
- g. Loss of pressure.

9.2.6.4 Hydraulic and Pneumatic Valves

Inspect for:

- a. Cracks in valve housing.
- b. Improper return of spool to neutral position.
- c. Leaks at spools or joints.
- d. Sticking spools.
- e. Failure of relief valves to attain correct pressure setting (relief valve pressures shall be checked as specified by the manufacturer).

9.2.6.5 Hydraulic and Pneumatic Cylinders

Inspect for:

- a. Drifting caused by fluid leaking across the piston.
- b. Rod seal leakage.
- c. Leaks at welded joints.
- d. Scored, nicked, or dented cylinder rods.
- e. Dented case (barrel).
- f. Loose or deformed rod eyes or connecting joints.

9.2.6.6 Hydraulic Filters

Evidence of rubber particles on the filter element may indicate deterioration of the hose, "O" ring, or other rubber components. Metal chips or pieces on the filter may denote failure in pumps, motors, or cylinders. Further checking will be necessary to determine the origin of the problem before corrective action can be taken.

9.2.6.7 Wire Rope

- a. A qualified inspector shall inspect wire ropes at least annually. More frequent intervals shall be determined by a qualified person and shall be based on such factors as expected rope life as determined by severity of environment, percentage of capacity lifts, frequency rates of

operation, and exposure to shock loads. The qualified inspector shall carefully note any deterioration, such as described below, that results in appreciable loss of original strength and determine whether further use of the rope constitutes an acceptable risk. This inspection shall include examination of the entire rope length without detaching it from the drum.

- 1. Reduction of rope size below nominal diameter, whether due to loss of core support, internal or external corrosion, or wear of outside wires (see Table 9-2).

Table 9-2. Maximum allowable rope reductions.

Rope diameter	Maximum allowable reduction from nominal diameter
Up to 5/16 in. (8 mm)	1/64 in. (0.4 mm)
Over 5/16 in. to 1/2 in. (13 mm)	1/32 in. (0.8 mm)
Over 1/2 in. to 3/4 in. (19 mm)	3/64 in. (1.2 mm)
Over 3/4 in. to 1 1/8 in. (29 mm)	1/16 in. (1.6 mm)
Over 1 1/8 in. to 1 1/2 in. (38 mm)	3/32 in. (2.4 mm)

- 2. The number and distribution or concentration of broken outside wires.
- 3. Worn outside wires.
- 4. Corroded or broken wires at end connections.
- 5. Corroded, cracked, bent, worn, or improperly applied end connections.
- 6. Kinking, crushing, cutting, or unstranding.

b. The qualified inspector shall take care when inspecting running rope where rapid deterioration could occur, such as in the following:

- 1. Sections in contact with saddles, equalizer sheaves, or other sheaves where rope travel is limited.
- 2. Sections of the rope at or near terminal ends where corroded or broken wires may protrude.

DOE-STD-1090-2001

c. The qualified inspector shall take care when inspecting certain ropes such as the following:

1. Rotation-resistant ropes, because of their higher susceptibility to damage. The internal deterioration of rotation-resistant ropes may not be readily observable.

2. Boom hoist ropes, because of the difficulties of inspection and the important nature of these ropes.

d. No precise rules can be given for determining the exact time to replace wire rope because many factors are involved. Safety in this respect depends largely on the use of good judgment by an appointed person in evaluating remaining strength in a used rope, after allowance for deterioration disclosed by inspection. Safety of rope operation depends on this remaining strength.

e. Conditions such as the following shall be sufficient reason for questioning wire-rope safety and for considering replacement:

1. In running ropes, 6 randomly distributed broken wires in one rope lay, or 3 broken wires in one strand in one rope lay.

2. In standing ropes, more than two broken wires in one lay in sections beyond end connections or more than one broken wire at an end connection.

3. In rotation resistant ropes, two randomly distributed broken wires in six rope diameters or four randomly distributed broken wires in thirty rope diameters.

4. One outer wire broken at the point of contact with the core of the rope that has worked its way out of the rope structure and protrudes or loops out from the rope structure; additional inspection of this part of the rope is required.

5. Wear of one-third the original diameter of outside individual wires.

6. Kinking, crushing, birdcaging, or any other damage resulting in distortion of the rope structure.

7. Evidence of heat damage from any cause.

8. Reduction from nominal diameter greater than the amounts listed in Table 9-2.

f. All rope that has been idle for a month or more due to shutdown or storage of a crane on which it is installed shall be inspected before it is placed in service. This inspection shall be for all types of deterioration and shall be performed by an appointed person whose approval shall be required before further use of the rope. A written and dated report of the rope condition shall be filed.

g. In order to establish data as a basis for judging the proper time for replacement, a continuing inspection record shall be maintained.

h. Replacement rope shall be the same size, grade, and construction as recommended by the crane manufacturer, unless otherwise recommended by a rope or crane manufacturer due to actual working-condition requirements.

i. Never use discarded wire rope for slings.

9.2.7 Load Hooks/Load Blocks

Load hooks/load blocks that have been changed out shall be inspected by a qualified inspector before returning the crane to service. Inspection records shall be retained throughout the service life of the hook or load block and shall be readily available.

9.2.8 Cranes Not in Regular Use

a. A crane that has been idle for 1 month or more but less than 6 months shall be given an inspection according to the requirements of Section 9.2.5 before being placed in service.

b. A crane that has been idle for more than 6 months shall be given a complete inspection according to the requirements of Section 9.2.6 before being placed in service.

c. Standby cranes shall be inspected at least semiannually, according to the requirements of Section 9.2.6. Cranes exposed to adverse environments should be inspected more frequently.

9.3 TESTING

9.3.1 Operational Tests

The following shall be tested during an initial test:

- a. Load lifting and lowering mechanisms.
- b. Boom lifting and lowering mechanisms.
- c. Boom extension and retraction mechanism.
- d. Swinging mechanism.
- e. Travel mechanism.
- f. Safety devices.

9.3.2 Rated Load Test

- a. Prior to initial use, all cranes in which load-sustaining parts have been modified, replaced, or repaired shall be load-tested by a qualified inspector or under the direction of that inspector. A designated or authorized

person shall determine if repairs made to a crane are extensive and require a rated load test, or if repairs are routine maintenance and require only operational testing. The replacement of rope is excluded from this requirement. However, a functional test of the crane under a normal operating load should be made prior to putting it back in service.

- b. Test weights shall not exceed 110 percent of the rated capacity and shall be accurate to within -5 percent, +0 percent of stipulated values.

NOTE: Load tests shall not be conducted in locations where the lift meets the definition of a critical lift (see Chapter 1, "Terminology and Definitions").

- c. A written report shall be furnished by the inspector showing test procedures and confirming the adequacy of repairs or alterations. Test reports shall be kept on file and shall be readily available to appointed personnel.

آریا ایمن آوات

DOE-STD-1090-2001

**EXHIBIT I
(SAMPLE FORM)**

MOBILE CRANE LOAD TEST

LICENSE OR EQUIPMENT NO. _____ MAKE _____ DATE _____

HOUR METER-ODOMETER TOTAL _____ RATED CAPACITY _____

LOAD TEST INSPECTION REPORT

The following checklist identifies the items to be inspected prior to the load test. Any unusual conditions observed during the inspection should be noted in the Remarks section. Equipment shall be inspected by maintenance personnel prior to load test.

- NOTES:**
1. Qualified inspector shall verify the inspection is completed.
 2. Craftsmen shall initial and date all tests, work, and inspections completed below.

NO.	CRANE ITEM	DEFECT	OK	NA	NO.	CRANE ITEM	DEFECT	OK	NA
1	Wire Rope				13	Hoist Clutch Lining			
2	Cracked or Worn Sheaves & Drums				14	Hoist Drum Brake Bands			
3	Limit Switch (Anti-Two-Blocking)				15	Open Gears			
4	Boom				16	Boom Jibs (Where Applicable)			
5	Master Clutch				NO.	CARRIER ITEM	DEFECT	OK	NA
6	Steering Clutches				1	Steering Gears and Connections			
7	Hydraulic Pump				2	Brakes (Service and Hand)			
8	Hydraulic Controls				3	Tires and Wheels			
9	Hydraulic Hoses				4	General Lubrication			
10	Mechanical Controls					OPERATING TEST			
11	Drive Chains					OVERALL CONDITION			
12	Swing Clutches								

REMARKS (Unusual conditions—noises, structural cracks, misalignment, etc.)

SAFETY ITEMS: (Fire extinguisher, signs, guards, etc.)

CHAPTER 10

FORKLIFT TRUCKS

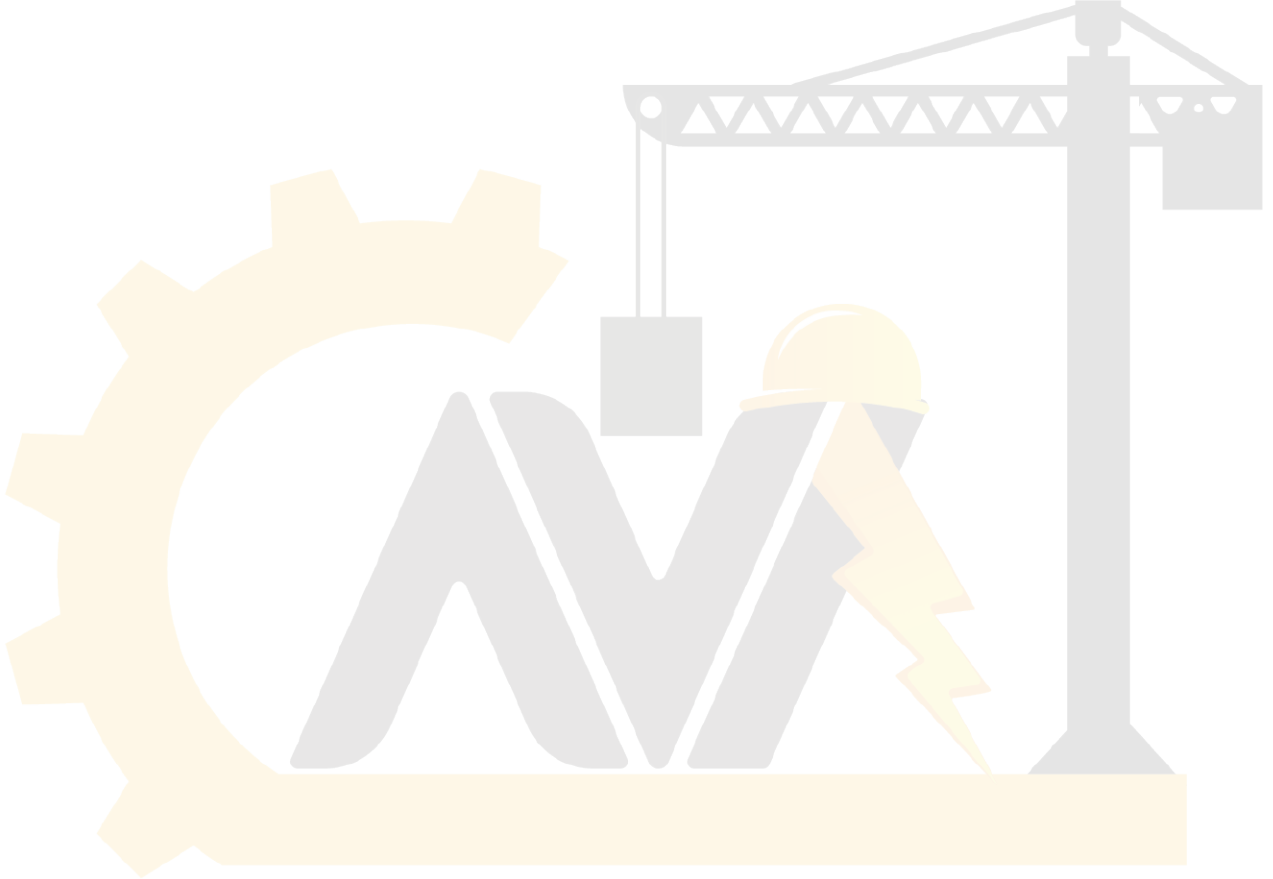

آریا ایمن آوات

10-1 GENERAL

This chapter specifies operation, inspection, testing, and maintenance requirements for industrial trucks powered by electric motors or internal-combustion engines. See Figures 10-3 for examples of powered industrial trucks.

Guidelines may also be taken from this chapter regarding pallet trucks and other small miscellaneous non-powered lift trucks (see Figure 10-4), but training, operating, maintenance, inspection, and testing requirements for non-powered equipment shall be based on the manufacturer's instructions and recommendations.

10.1.1 Operator Training/Qualification

Operators of forklift trucks shall be trained and qualified as described in Chapter 6, "Personnel Qualification and Training."

10.1.2 Rated Capacity

Rated capacity is the maximum weight the truck can transport and stack at a specified load center and for a specified load elevation. Trucks shall not be used or tested above their rated capacities.

10.1.3 Nameplate(s) and Marking

Every truck shall have appended to it a durable, corrosion-resistant nameplate(s), legibly inscribed with the following information:

- a. Truck model and truck serial number.
- b. Weight of truck.
- c. Rated capacity.
- d. Designation of compliance with the mandatory requirements of ASME B56.1, "Safety Standard for Low and High Lift Trucks," applicable to the manufacturer.
- e. Type designation to show conformance with the requirements, such as those prescribed

by Underwriters Laboratories, Inc., and Factory Mutual Research Corporation.

- f. Batteries for use in electric trucks shall have the battery weight legibly stamped on the battery tray near the lifting means as follows: Service Weight _____ lb(kg).

In addition to the above requirements, additional information is required (and allowed) on nameplates on high-lift trucks, electric trucks, and trucks intended for hazardous locations (see ASME B56.1, Section 7.5, "Nameplates and Markings").

10.1.3.1 Fork Arm Data

For forklift trucks purchased after December 1984, each fork arm shall be clearly stamped with its rated capacity in an area readily visible and not subject to wear. For example, the designation 1500 @ 24 means 1,500-lb (680-kg) capacity at 24-in. (600-mm) load center.

10.1.4 Attachments

Attachments almost always affect rated capacity of the truck. When a forklift truck is equipped with an attachment, the rated capacity of the truck/attachment combination shall be established by the truck manufacturer. Capacity, operation, and maintenance instruction plates, tags, or decals shall be changed accordingly.

- a. The rated capacity of an attachment/truck combination shall not be exceeded.
- b. On every removable attachment (excluding fork extensions), a corrosion-resistant nameplate with the following information is required:
 1. Model number
 2. Serial number on hydraulically actuated attachments
 3. Maximum hydraulic pressure (on hydraulically actuated attachments)
 4. Weight
 5. Capacity

DOE-STD-1090-2001

6. The following instructions (or equivalent); "Capacity of truck and attachment combination may be less than capacity shown on attachment. Consult truck nameplate."

NOTE: The above information should be provided by the attachment manufacturer.

10.1.5 Modifications

Modifications or additions that affect capacity or safe operation shall not be performed without prior written approval from the forklift truck manufacturer. Capacity, operation, and maintenance instruction plates, tags, or decals shall be changed accordingly.

10.1.6 Warning Devices

a. Every truck shall be equipped with an operator-controlled horn, whistle, gong, or other sound-producing device(s).

b. The using organization shall determine if operating conditions require the truck to be equipped with additional sound-producing or visual devices (such as lights or blinkers), and shall be responsible for providing and maintaining such devices. Backup or motion alarms that sound continuously may be warranted in special cases but generally are less effective than operator-controlled devices.

10.1.7 Overhead Guards

An overhead guard is intended to offer protection to the operator from falling objects, but it cannot protect against every possible impact. Therefore, it should not be considered a substitute for good judgement and care in load handling.

a. High lift rider trucks, including order picker trucks, shall be equipped with an overhead guard manufactured in accordance with ASME B56.1, unless the following conditions are met:

1. Vertical movement of the lifting mechanism is restricted to 72 in. (1800 mm) or less from the ground.

2. The truck will be operated only in an area where:

i. The bottom of the top tiered load is not higher than 72 in. (1800 mm) and the top is not more than 120 in. (3000 mm) from the ground where tiered.

ii. Only stable (preferably interlocked, unitized or containerized) loads are handled.

iii. There is protection against falling objects from adjacent high stack areas.

b. Rough terrain forklift trucks shall be fitted with an overhead guard manufactured in accordance with ASME B56.6.

10.1.8 Fire Hazard Areas

Powered forklift trucks for operation in fire hazard areas shall be of the type recommended in ANSI/NFPA 505 ("Powered Industrial Trucks, Type Designation and Areas of Use").

10.1.9 Work Atmosphere

a. The operation of forklift trucks may effects the concentrations of carbon monoxide and oxygen in the work location. Concentrations of these materials in the work location must meet the requirements of 29 CFR 1910.1000, Table Z-1 Limits For Air Contaminants, Occupational Safety and Health Standards for General Industry.

b. Where general lighting is less than 2 lumens per square foot, auxiliary directional lighting shall be provided on the truck.

Figure 10-3. Types of Trucks. (Sheet 1 of 6)

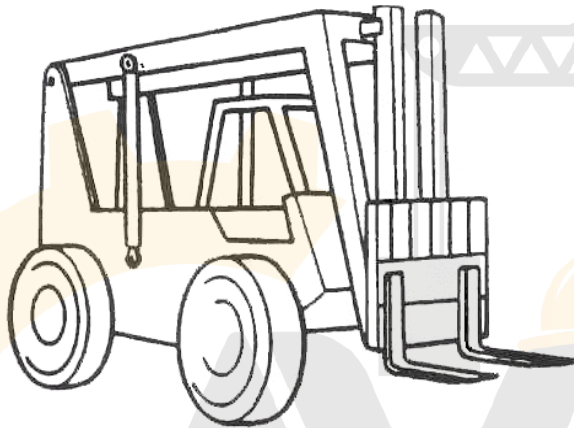

- Variable Reach Truck Linkage Type
- Four Wheel Steer
- Two Wheel Steer
- Four Wheel Drive
- Two Wheel Drive

- Variable Reach Truck Boom Type
- Four Wheel Steer
- Two Wheel Steer
- Four Wheel Drive
- Two Wheel Drive

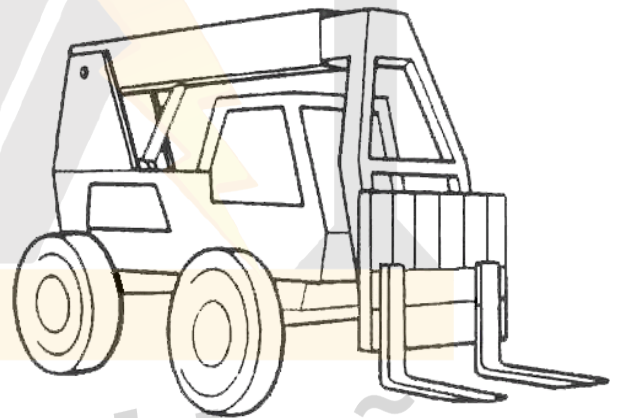

- Variable Mast
- Two Wheel Steer
- Two Wheel Drive

Figure 10-3. Types of Trucks. (sheet 2 of 6)

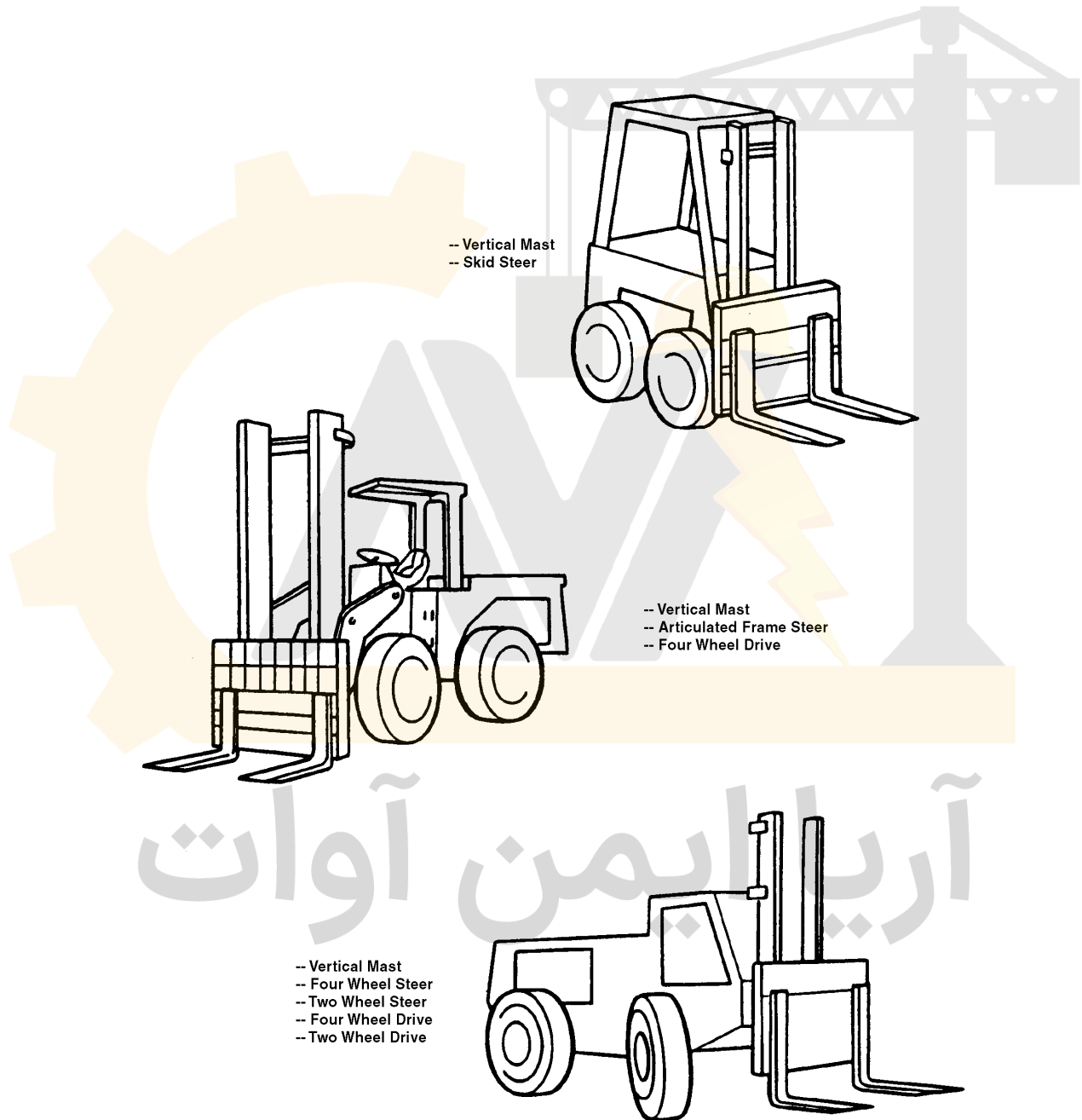
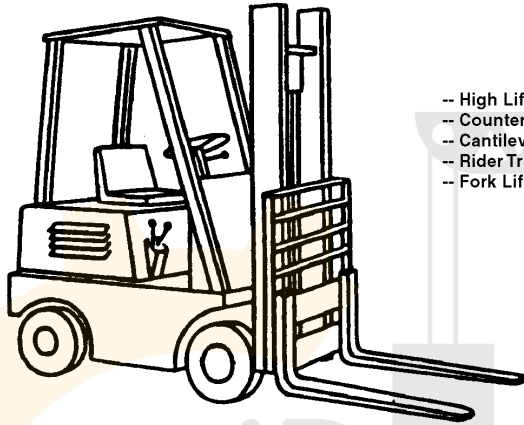
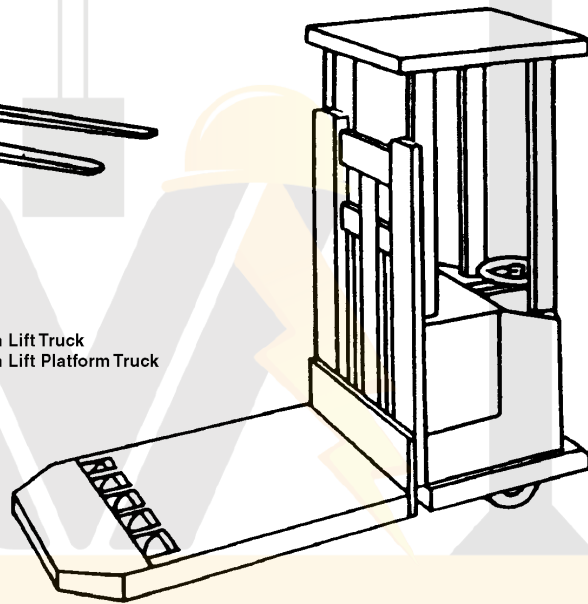

Figure 10-3. Types of Trucks. (sheet 3 of 6)



- High Lift Truck
- Counterbalanced Truck
- Cantilever Truck
- Rider Truck
- Fork Lift Truck



- High Lift Truck
- High Lift Platform Truck

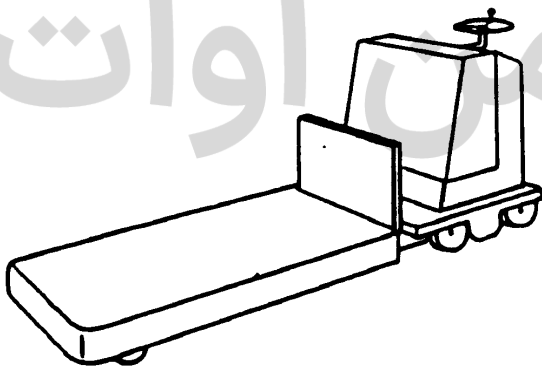

- Low Lift Truck
- Low Lift Platform Truck

Figure 10-3. Types of Trucks. (sheet 4 of 6)

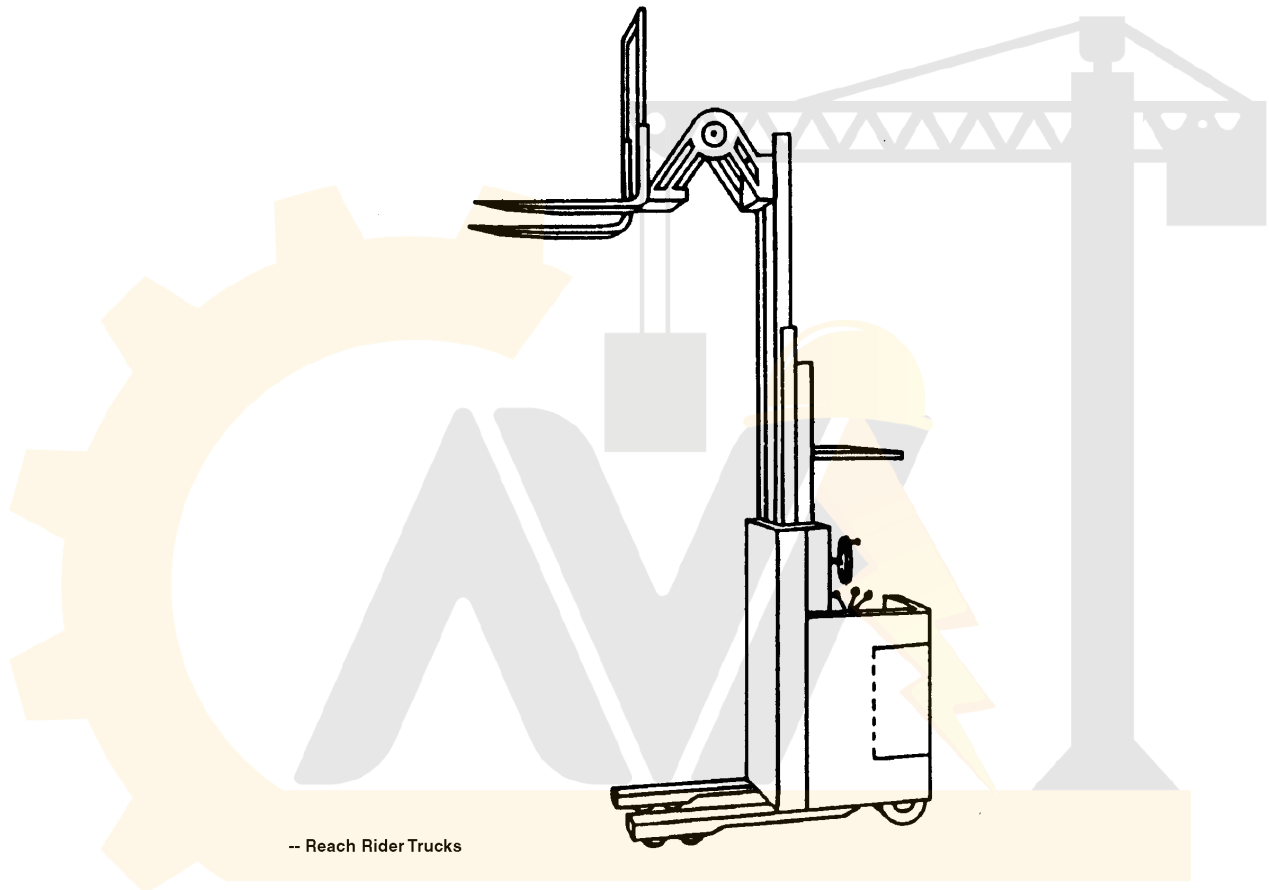

-- Reach Rider Trucks

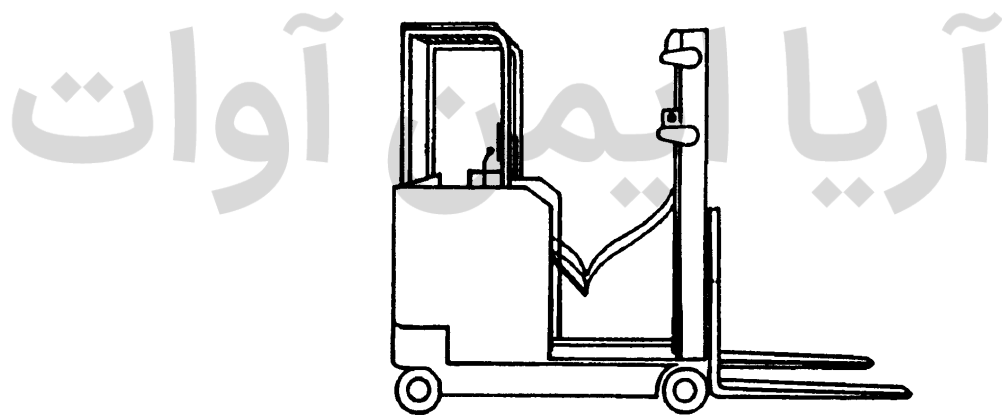

Figure 10-3. Types of Trucks. (sheet 5 of 6)

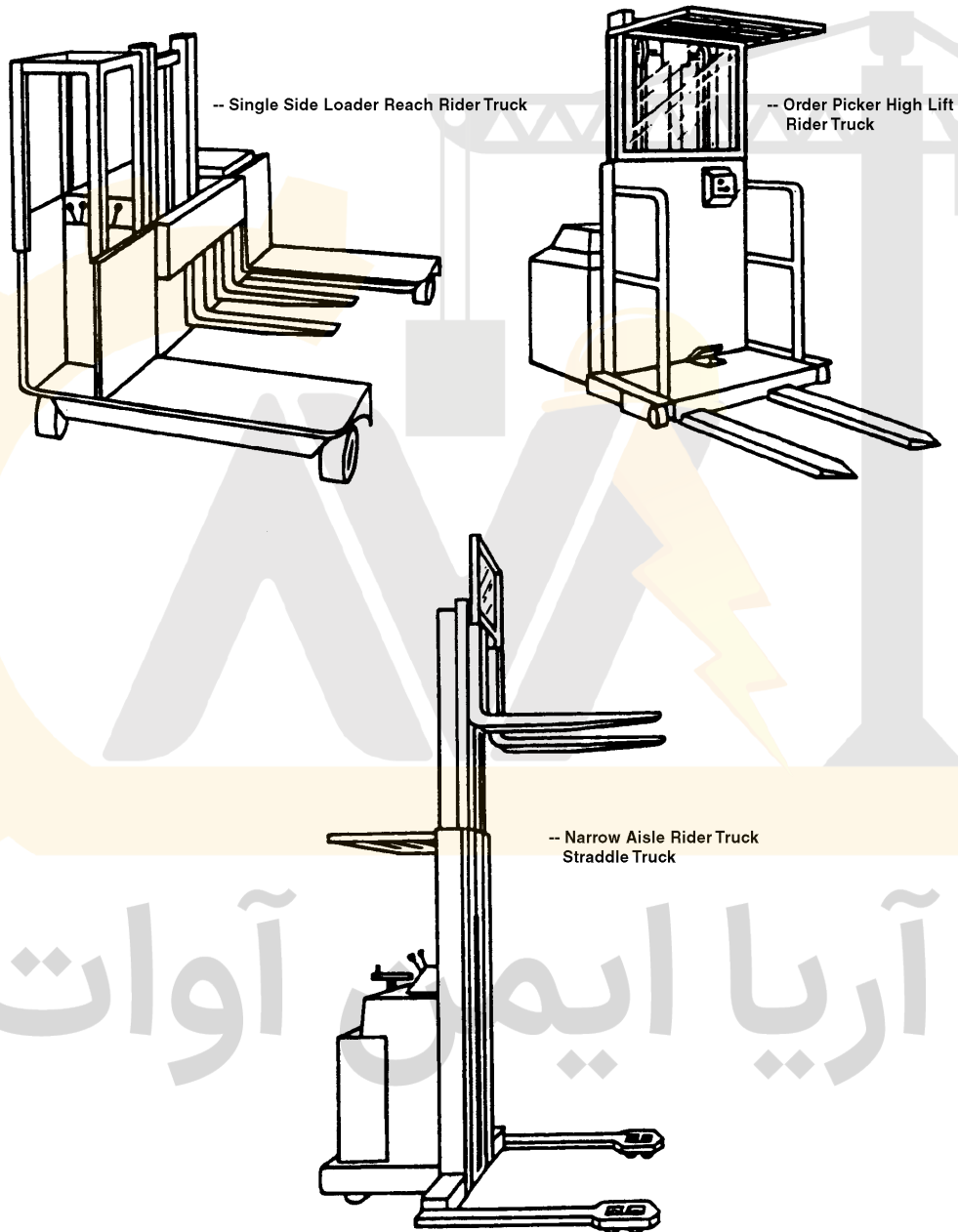
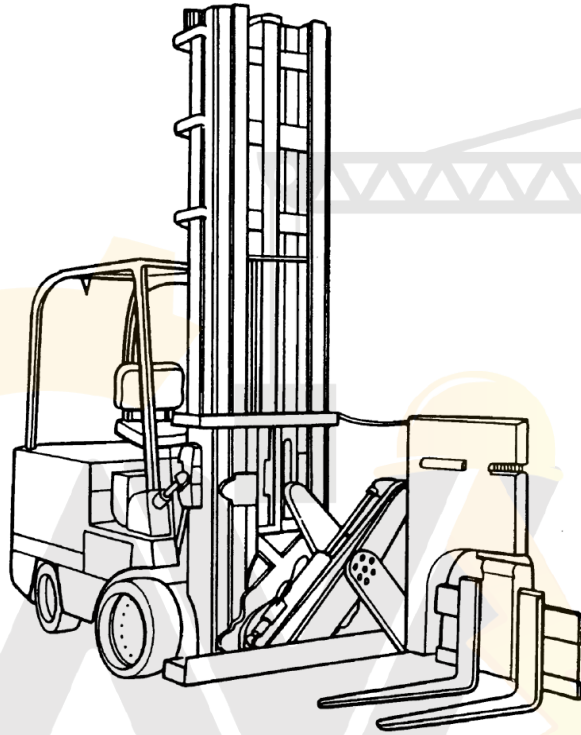
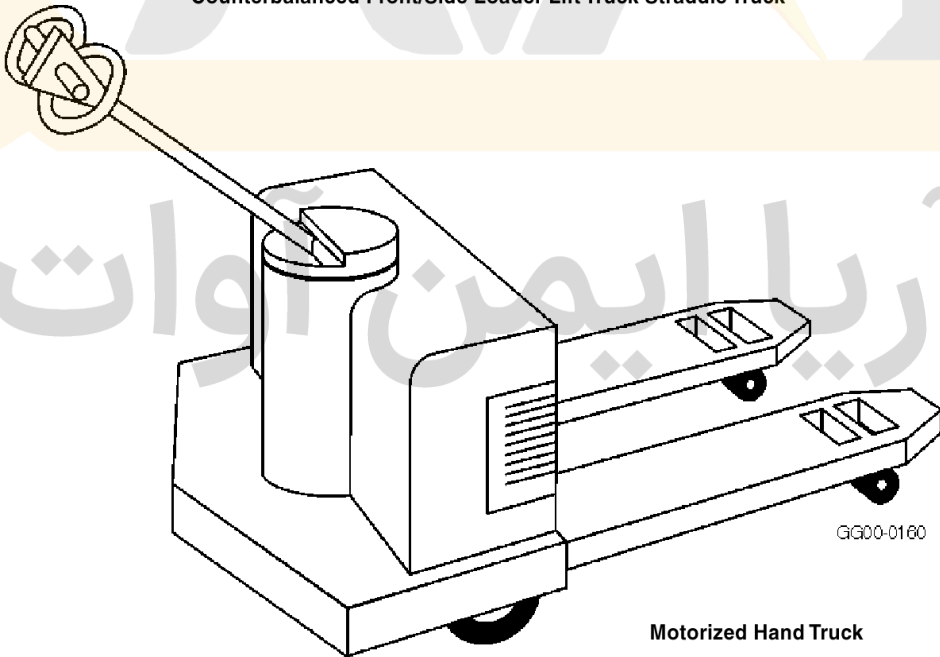

Figure 10-3. Types of Trucks. (sheet 6 of 6)



Counterbalanced Front/Side Loader Lift Truck Straddle Truck



Motorized Hand Truck

Figure 10-4. Manually Operated Pallet Trucks

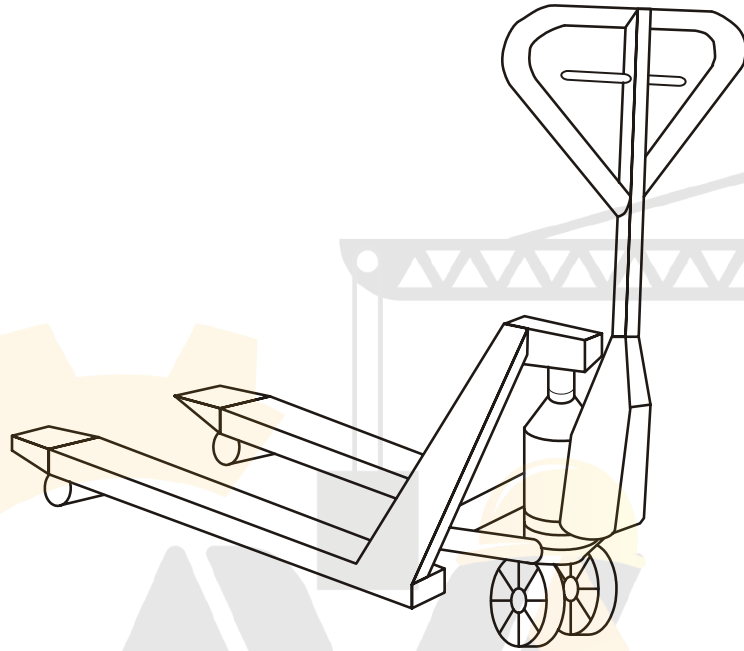

GA99 0028

- Small Miscellaneous Truck

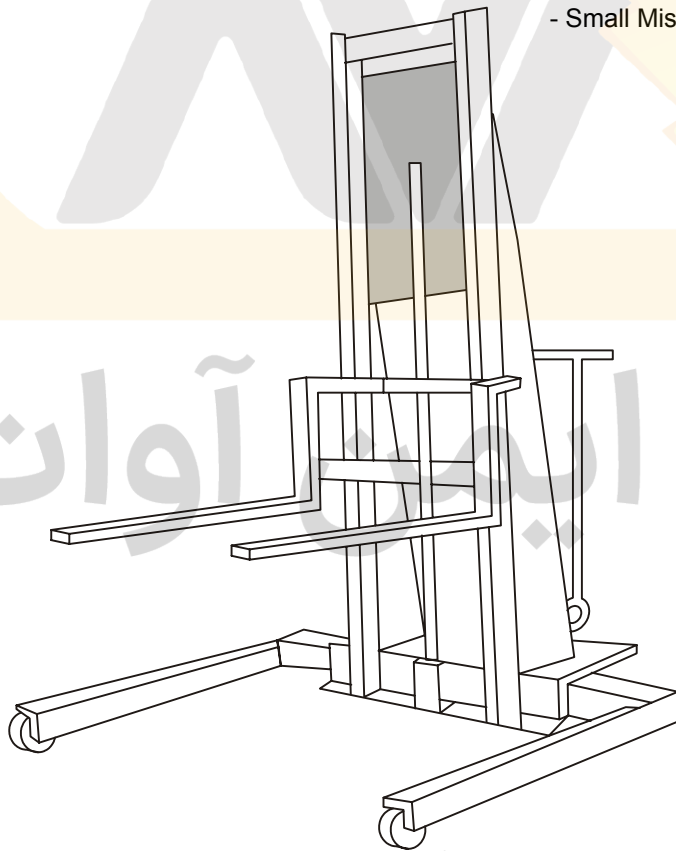

GA99 0029

10.2 TYPE DESIGNATIONS AND AREAS OF USE

10.2.1 Type Designation

It is essential to use proper equipment in hazardous (explosive) areas. Trucks approved for use in hazardous areas shall have the manufacturer's label or some other identifying mark indicating approval for the intended use by a recognized national testing laboratory [e.g., Underwriters Laboratories (UL) or Factory Mutual (FM)].

- a. Durable markers indicating the designation of the type of truck for use in hazardous areas shall be applied to each side of the vehicle in a visible but protected area. These markers shall be distinctive in shape, as indicated in Figure 10-1.
- b. Hazardous-Area Signs. The entrance to hazardous areas shall be posted with a sign to identify the type of forklift truck permitted, see Figure 10-2, or the truck shall be clearly marked as to the area(s) it is not to enter.

10.2.1.1 Non-Hazardous Areas

The following units are not suitable for use in hazardous areas since they include only minimum safeguards against inherent fire hazards:

- a. *Type D Forklifts* — diesel-powered units having minimum acceptable safeguards against inherent fire hazards
- b. *Type E Forklifts* — electrically powered units having minimum acceptable safeguards against inherent fire and electrical shock hazards
- c. *Type G Forklifts* — gasoline-powered units having minimum acceptable safeguards against inherent fire hazards
- d. *Type LP Forklifts* — liquefied-petroleum-gas-powered units having minimum acceptable safeguards against inherent fire hazards

10.2.1.2 Hazardous Areas

The following units are suitable for use in hazardous areas since they are equipped with additional safeguards (i.e., special exhaust, fuel, or electrical systems) or other modifications against inherent fire hazards:

- a. *Type DS Forklifts* — diesel-powered units that are provided with all the requirements for the type D units and that have additional safeguards to the exhaust, fuel, and electrical systems
- b. *Type DY Forklifts* — diesel-powered units that have all the safeguards of the type DS units except that they do not have any electrical equipment, including ignition; they are equipped with temperature-limitation features
- c. *Type ES Forklifts* — electrically powered units that are provided with all the requirements for the type E units and that have additional safeguards to the electrical system to prevent emission of hazardous sparks and to limit surface temperatures
- d. *Type EE Forklifts* — electrically powered units that are provided with all the requirements for the type E and ES units, and that also have electric motors and all other electrical equipment completely enclosed
- e. *Type EX Forklifts* — electrically powered units that differ from type E, ES, or EE units in that the electrical fittings and equipment are designed, constructed, and assembled so that the units may be used in atmospheres containing specifically named flammable vapors, dusts, and, under certain conditions, fibers; type EX units are specifically tested and classified for use in Class I, Group D, or for Class II, Group G locations as defined in NFPA 70, *National Electrical Code*

DOE-STD-1090-2001

f. *Type GS Forklifts* — gasoline-powered units that, in addition to all the requirements for the type G units, are provided with additional safeguards to the exhaust, fuel, and electrical systems

g. *Type LPS Forklifts* — liquefied-petroleum-gas-powered units that, in addition to the requirements for the type LP units, are provided with additional safeguards to the exhaust, fuel, and electrical systems.

10.2.2 Specific Areas of Use

The atmosphere or location where the powered forklift is to be used shall be classified. Location classifications are described as follows:

a. *Class I* — locations in which flammable gases or vapors are present or may be present in the air in quantities sufficient to produce explosive or ignitable mixtures.

b. *Class II* — locations that are hazardous because of the presence of combustible dust.

c. *Class III* — locations where easily ignitable fibers or filings are present but are not likely to be suspended in quantities sufficient to produce ignitable mixtures.

d. *Unclassified* — locations not possessing atmospheres defined as Class I, II, or III locations.

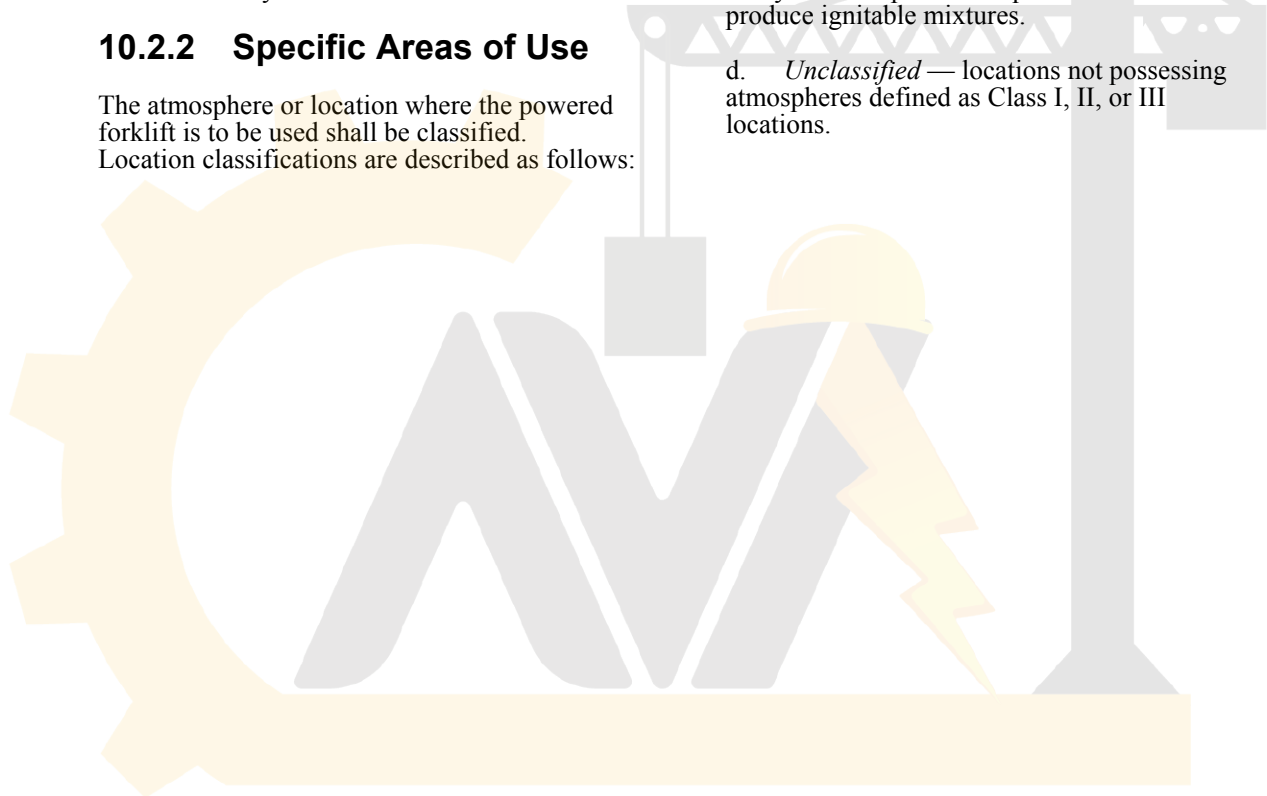

آریا ایمن آوات

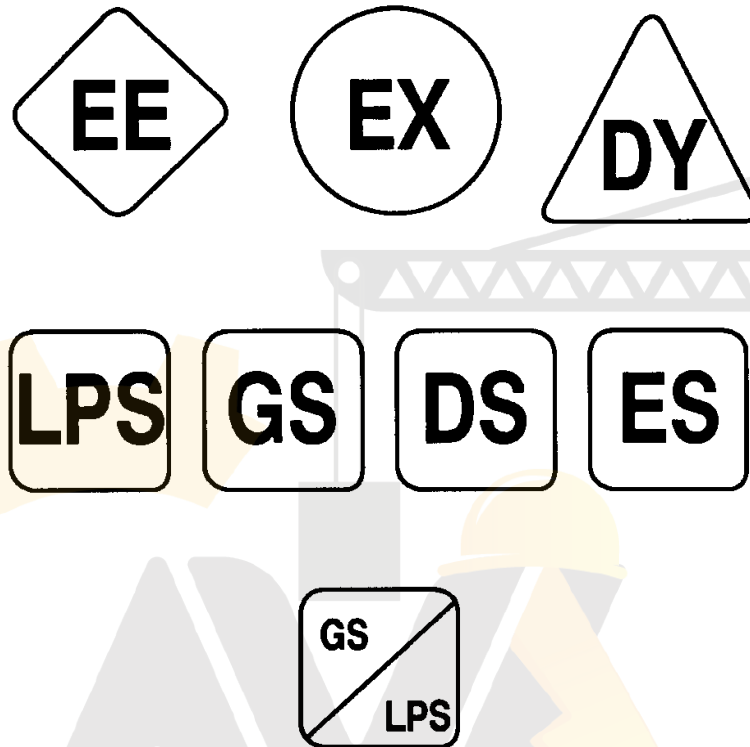

NOTE: The markers for EE, EX, and DY are 5 in. (12.7 cm) high. The rest are 4 in. (10 cm) square. The signs shall have black borders and lettering on a yellow background.

Figure 10-1. Markers to identify type of industrial truck.

آریا ایمن آوات

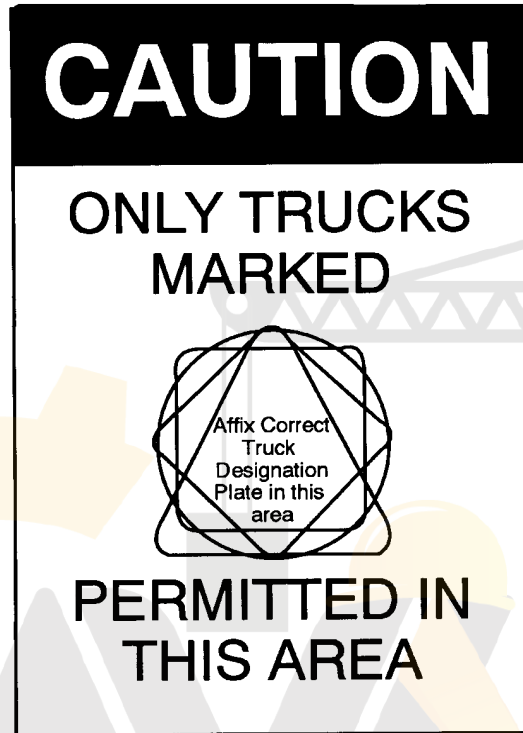

Figure 10-2. Building signs for posting at entrance to hazardous areas.

NOTE: The minimum width of the sign is 11 in. (28 cm); the minimum height is 16 in. (40 cm). The sign shall have the word "caution" in yellow letters on a black background. The body of the sign shall have black letters on a yellow background. A marker identical to the one used on the side of the truck as shown in Figure 10-1, shall be installed on the sign.

آریا ایمن آوات

CHAPTER 11

WIRE ROPE AND SLINGS

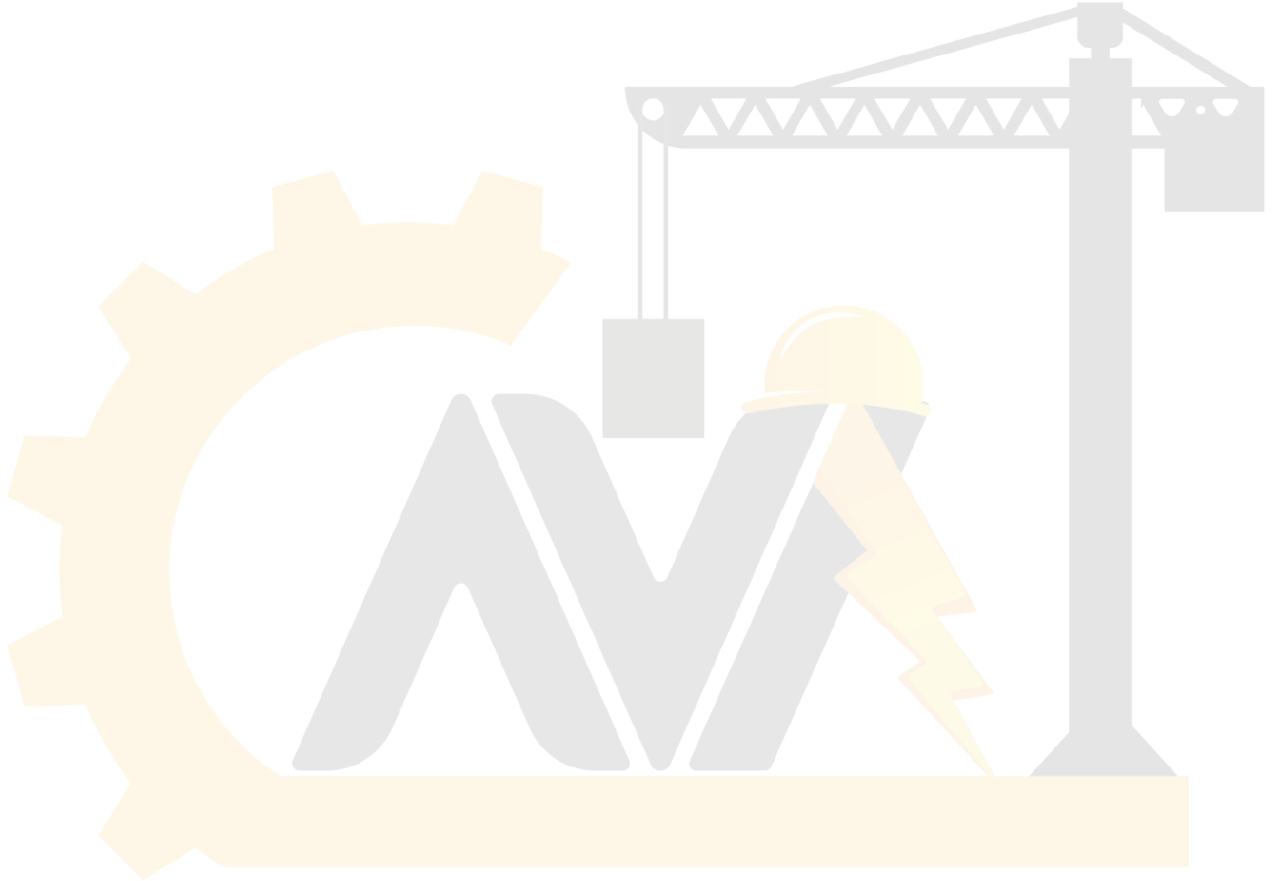

آریا ایمن آوات

11.2 WIRE ROPE

11.2.1 Wire-Rope Lays

- a. In a right-lay rope, the strands twist to the right around the core like a conventional screw thread; in a left-lay rope, the strands twist to the left.
- b. A rope has a lang lay when the strands and the individual wires have the same lay direction. When the strands and the wires have an opposite lay direction, the rope has a regular lay.
- c. A standard wire rope, unless otherwise stated, is understood to be right regular lay. With few exceptions, all wire rope is made right lay. Left-lay rope is a special-purpose rope.
- d. Figure 11-2 shows ropes with right and left lays combined with regular and lang lays.
- e. Lay length is the lengthwise distance measured along a wire rope in which a strand makes one complete revolution about the rope's axis.

11.2.2 Wire-Rope Cores

- a. Wire rope consists of multistrand metal wires wrapped around a suitable core material. Wire-rope cores are carefully designed and must be precisely manufactured to close tolerances to ensure a perfect fit in the rope. The most common types of cores include the following (see Figure 11-3):

1. **Fiber Core (FC) or Sisal Core**—Sisalanna is the most common fiber that is used in the manufacture of wire-rope cores. In smaller ropes, cotton and jute are sometimes used for the core.

2. **Independent Wire-Rope Core (IWRC)**—The primary function of the core is to provide adequate support for the strands. As the name implies, an IWRC is a separate small-diameter wire rope that is used as the core for a larger wire rope. When severe crushing or flattening of the rope is encountered, an IWRC is usually specified.

3. **Strand Core**—This type of core has a single strand used as the core. This type is generally confined to the smaller ropes as a substitute for IWRC. The strand core may or may not have the same cross section as the surrounding strands.

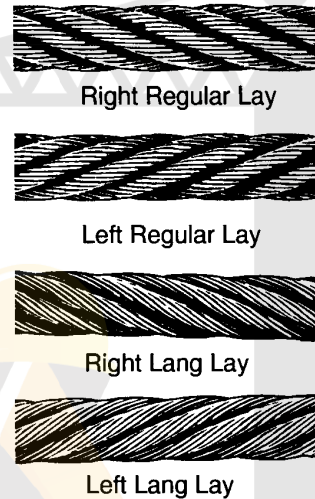
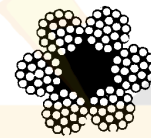
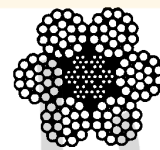

Figure 11-2. Wire-rope lays.



Fiber or Sisal Core



Independent Wire-Rope Core

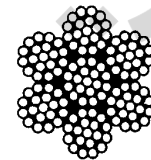

Strand Core

Figure 11-3. Wire-rope cores.

11.2.3 Wire Rope for General Purposes

11.2.3.1 6 × 19 Classification

a. Most applications can use a rope from this classification; it is the most versatile of all ropes made. Figure 11-4 shows four varieties of 6 × 19 wire ropes with FCs and IWRCs. Table 11-2 provides breaking strengths for 6 × 19 wire ropes with FC and IWRC cores.

b. The principal types of ropes in this classification include:

1. **6 × 19F**—The most popular and versatile of all wire ropes and the most flexible is the 6 × 19F classification. This rope is considered the perfect compromise between maximum abrasion resistance and maximum flexibility.
2. **6 × 16F**—Slightly more abrasion resistant than the 6 × 19F, the 6 × 16F makes an excellent rope for small draglines and similar uses. The resistance to wear is gained by a slight sacrifice in flexibility.
3. **6 × 19 Seale**—The 6 × 19 Seale is a rugged wire rope for applications involving heavy wear. Car pullers often use this rope, and it is widely used for slushers and drag scrapers.
4. **6 × 19 Warrington**—The alternating large and small outer wires make this rope an all-around performer. The 6 × 19 Warrington is used for general-purpose hoisting, churn drills, and miscellaneous slings.

11.2.3.2 6 × 37 Classification

a. When sheaves and drums are fairly small and abrasive conditions are not severe, the ropes in this classification will show better performance than the coarser 6 × 19 construction. Under conditions of repeated bending, they will outlast a 6 × 19 rope; when abrasion is severe, the small outer wires quickly show the effect. Figure 11-5 shows three varieties of 6 × 37 wire rope with FC and IWRC cores. Table 11-3 provides breaking strengths for 6 × 37 wire ropes with FC and IWRC cores.

b. The principal types of ropes in this classification include:

1. **6 × 37 2-operation**—A 6 × 37 2-operation strand has 18 outer wires. This construction is used on industrial equipment, for flexible slings, and in miscellaneous hoisting.

2. **6 × 29F**—A 6 × 29F is used for applications requiring a flexible rope slightly more resistant to wear than the 6 × 37 2-operation rope.

3. **6 × 41**—A 6 × 41 rope is used widely for ropes over 1-in. diameter in the 6 × 37 classification.

11.2.4 Wire-Rope Inspections

A qualified inspector shall inspect wire ropes at least annually. Inspection requirements vary depending on what type of equipment the wire ropes are used on. Refer to other sections in this standard, based on the equipment being used, for specific inspection requirements.

11.2.5 Wire-Rope Maintenance

Personnel using wire rope shall ensure proper care by doing the following:

- a. Store rope to prevent damage or deterioration.
- b. Unreel or uncoil rope as recommended by the rope manufacturer or a qualified person and with care to avoid kinking or inducing a twist.
- c. Before cutting a rope, use some method to prevent unlaying of the strands. Heat-affected zones of flame cut wire rope shall not be allowed to bear load.
- d. During installation, avoid dragging the rope in the dirt or around objects that will scrape, nick, crush, or induce sharp bends.
- e. Unless prohibited by other considerations, maintain rope in a well-lubricated condition. The object of rope lubrication is to reduce internal friction and to prevent corrosion. Ensure that lubricant applied as a part of a maintenance program is compatible with the original lubricant and is also a type that does not hinder visual inspection. Those sections of rope in contact with sheaves or otherwise hidden during inspection and maintenance procedures require special attention when lubricating rope.

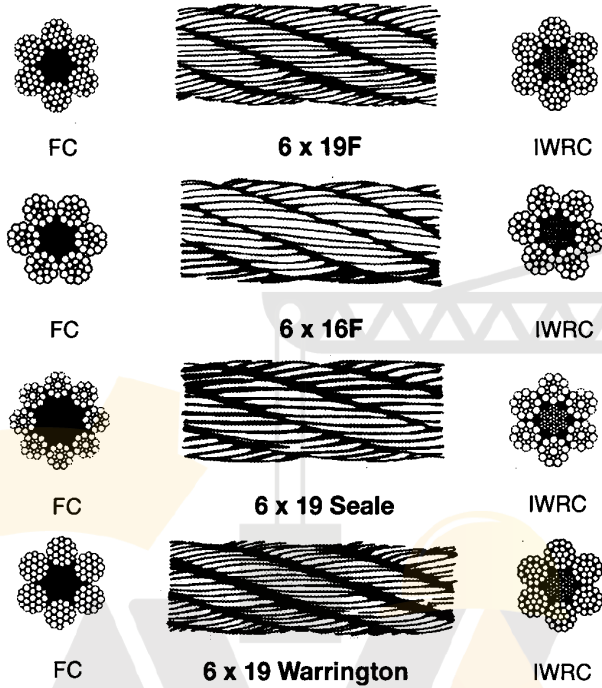

Figure 11-4. 6 x 19 classification of wire rope.

Table 11-2. Breaking strength of wire rope (6 x 19 classification).

6 x 19 (FC)				6 x 19 (IWRC)			
Rope diameter (in.)	Weight (lb per ft)	Breaking strength in tons of 2,000 lb		Rope diameter (in.)	Weight (lb per ft)	Breaking strength in tons of 2,000 lb	
		Plow steel	Improved plow steel			Plow steel	Improved plow steel
3/16	0.06	1.3	1.5	3/16	0.07	1.4	1.6
1/4	0.10	2.4	2.7	1/4	0.11	2.6	2.9
5/16	0.16	3.8	4.1	5/16	0.18	4.1	4.4
3/8	0.23	5.4	6.0	3/8	0.25	5.8	6.5
7/16	0.31	7.0	8.0	7/16	0.34	7.5	8.6
1/2	0.40	10.0	11.0	1/2	0.44	10.8	11.8
9/16	0.51	11.7	13.3	9/16	0.56	12.6	14.3
5/8	0.63	15.0	16.5	5/8	0.69	16.1	17.7
3/4	0.90	21.5	23.8	3/4	0.99	23.1	25.6
7/8	1.23	28.3	32.0	7/8	1.35	30.4	34.4
1	1.60	38.0	41.7	1	1.76	40.8	44.8
1 1/8	2.03	48.5	53.0	1 1/8	2.23	52.1	57.0
1 1/4	2.50	60.0	65.0	1 1/4	2.75	64.5	70.4
1 3/8	3.03	73.5	81.0	1 3/8	3.33	79.0	87.1
1 1/2	3.60	88.5	96.0	1 1/2	3.96	95.1	103.0
1 5/8	4.23	103.0	113.0	1 5/8	4.65	111.0	122.0
1 3/4	4.90	119.0	130.0	1 3/4	5.39	128.0	140.0
1 7/8	5.63	138.0	152.0	1 7/8	6.19	148.0	163.0
2	6.40	154.0	169.0	2	7.04	166.0	182.0
2 1/4	8.10	193.0	210.0	2 1/4	8.91	208.0	226.0
2 1/2	10.00	235.0	260.0	2 1/2	11.00	253.0	280.0
2 3/4	12.10	280.0	305.0	2 3/4	13.30	301.0	328.0

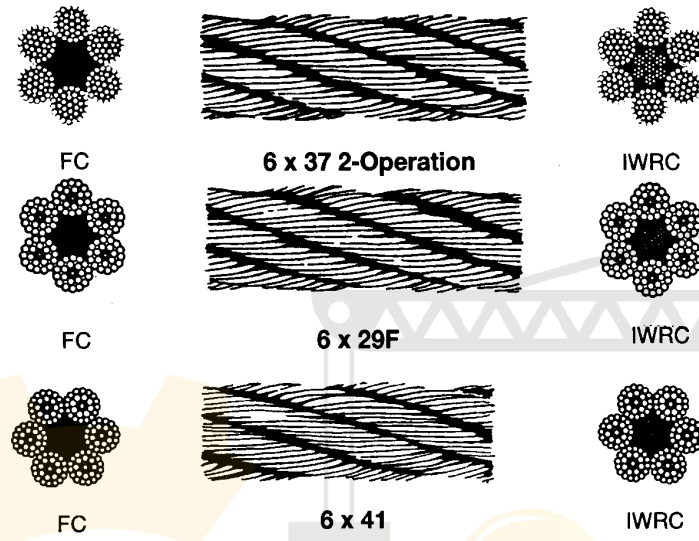

Figure 11-5. 6 x 37 classification of wire rope.

Table 11-3. Breaking strength of wire rope (6 x 37 classification).

6 x 37 (FC)				6 x 37 (IWRC)			
Rope diameter (in.)	Weight (lb per ft)	Breaking strength in tons of 2,000 lb		Rope diameter (in.)	Weight (lb per ft)	Breaking strength in tons of 2,000 lb	
		Plow steel	Improved plow steel			Plow steel	Improved plow steel
1/4	0.10	2.2	2.5	1/4	0.11	2.4	2.7
5/16	0.16	3.8	4.0	5/16	0.18	4.1	4.3
3/8	0.22	5.0	5.5	3/8	0.24	5.4	5.9
7/16	0.30	6.9	7.5	7/16	0.33	7.4	8.1
1/2	0.39	9.2	10.0	1/2	0.43	9.9	10.8
9/16	0.49	11.4	12.5	9/16	0.54	12.3	13.4
5/8	0.61	14.5	16.0	5/8	0.67	15.6	17.2
3/4	0.87	20.2	22.2	3/4	0.96	21.7	23.9
7/8	1.19	27.5	30.2	7/8	1.30	29.6	32.5
1	1.55	36.0	39.5	1	1.71	38.7	42.5
1 1/8	1.96	44.0	49.0	1 1/8	2.16	47.3	52.7
1 1/4	2.42	55.0	61.0	1 1/4	2.66	59.1	65.6
1 3/8	2.93	68.5	74.5	1 3/8	3.22	73.6	80.1
1 1/2	3.49	82.0	90.0	1 1/2	3.84	88.1	96.7
1 5/8	4.09	96.5	105.5	1 5/8	4.50	104.0	113.0
1 3/4	4.75	110.0	121.0	1 3/4	5.23	118.0	130.0
1 7/8	5.45	129.0	142.0	1 7/8	6.00	139.0	153.0
2	6.20	142.0	155.0	2	6.82	153.0	167.0
2 1/4	7.85	182.0	201.0	2 1/4	8.64	196.0	216.0
2 1/2	9.69	225.0	245.0	2 1/2	10.66	242.0	263.0
2 3/4	11.72	269.0	293.0	2 3/4	12.89	289.0	315.0
3	13.95	323.0	353.0	3	15.35	347.0	379.0

11.3 SLINGS

11.3.1 General

a. Slings shall have a minimum design factor appropriate to the type of material as specified in the appropriate section. Features that affect the rated capacity of the sling and that shall be considered in calculating the design factor are:

1. Nominal breaking strength of material from which it is constructed.
2. Splicing or end-attachment efficiency.
3. Number of parts in the sling.
4. Type of hitch (e.g., straight pull, choker hitch, or basket hitch).
5. Angle of loading and load center of gravity.
6. Diameter of curvature around which the sling is bent.

b. Published working loads for chain slings are usually based on 25–33 percent of the breaking strength.

c. The center of gravity of an object is a point around which the entire weight may be concentrated. To make a level lift, the crane hook or point of suspension must be directly above this point. While slight variations are usually permissible, if the crane hook is too far to one side of the center of gravity, dangerous tilting will result and should be corrected at once. For this reason, when the center of gravity is closer to one point of the sling attachment than to the other, the slings must be of unequal length. Sling stresses and sling angles will also be unequal (see Figure 11-6).

d. Rigging shall be configured such that slings do not reeve or slip through the hook. To attach the load, locate the center of gravity, position the crane hook directly above the center of gravity, and then rig the load so that it will lift level and true.

11.3.1.1 Load Angle Factor

a. The following is an example of selecting a sling using the load angle factors shown in Figure 11-7.

1. Load = 1,000 lb.
2. Sling = 2-legged bridle.
3. Angle with horizontal = 45 degrees.
4. Load angle factor from Figure 11-7 = 1.414.

b. Each of the two legs would lift 500 lb if a vertical lift were made. However, there is a 45 sling angle involved. Therefore, the 500-lb load would be multiplied by the load-angle factor in the chart, giving a total of 707 lb ($500 \text{ lb} \times 1.414$) tension in each sling leg. Each sling leg, therefore, must have a rated capacity of at least 707 lb.

11.3.1.2 Safe Load

a. The rated capacity or working load limit (WLL) of a sling varies depending on the type of hitch. The rated capacity tables in this section show the applications for which the various safe loads apply when the slings are new. All ratings are in pounds (lbs).

b. Figures 11-8 and 11-9 provide information for determining the total rated capacity of 3-leg and 4-leg bridle slings. Select multiple-leg slings so as not to introduce a working load in direct tension in any leg greater than that permitted. Two legs should be considered to carry the load because in normal lifting practice, the load will not be uniformly distributed on all legs. If rigging techniques, verified by a qualified rigger, ensure that the load is evenly distributed then full use of three legs is allowed. Special rigging techniques verified by a member of a qualified engineering organization shall be required to prove that a load is evenly distributed over four or more sling legs.

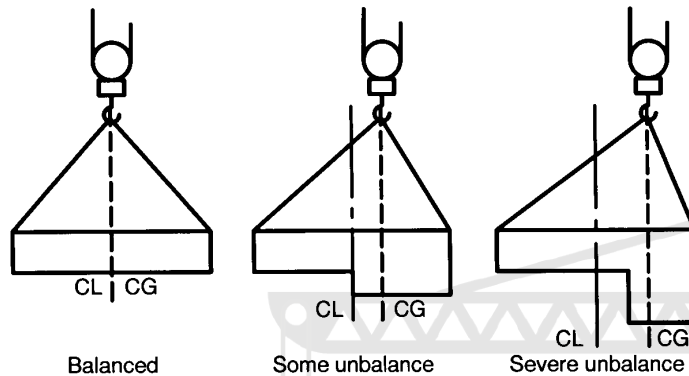

Note:
 CL = Centerline
 CG = Center of Gravity

Figure 11-6. Balancing loads.

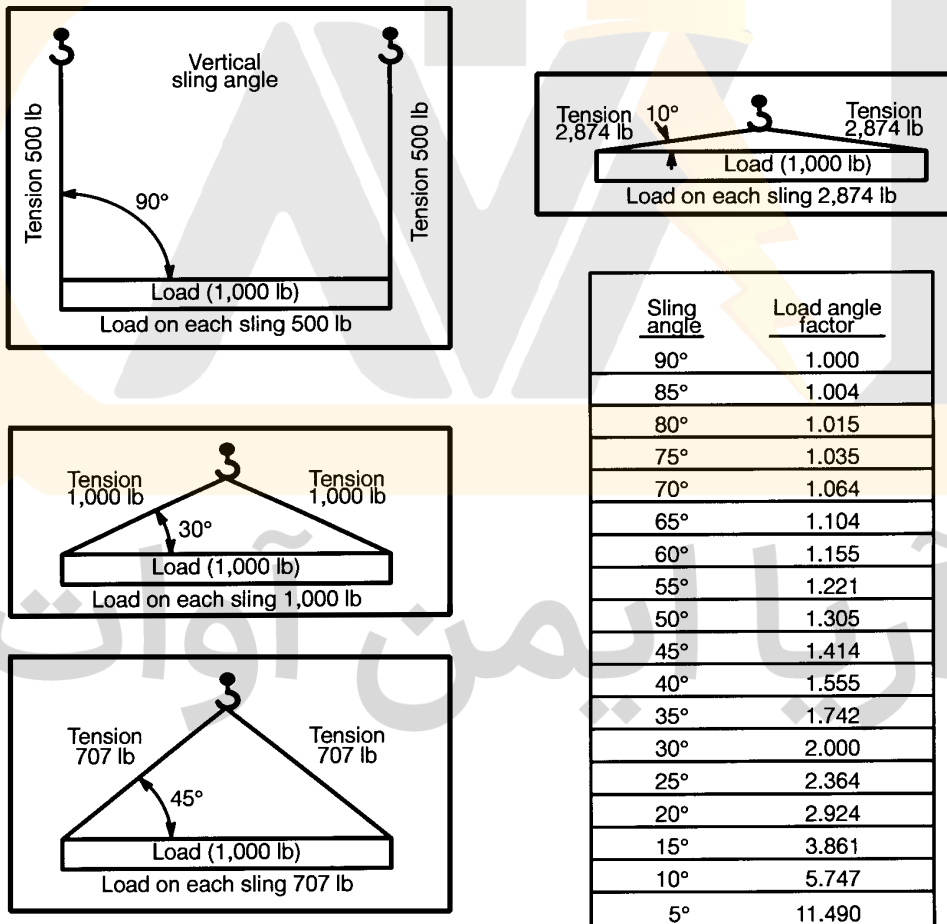

Figure 11-7. Relationship of load angle and lifting efficiency.

11.3.1.3 Design Factor

In general, a design factor of 5:1 is maintained throughout this section. However, certain sling fittings, such as hooks (which will straighten without breaking) or links (which will deform beyond usefulness before breaking) cannot be assigned a definite numerical design factor. In such cases, suitable safe loads are listed, based on wide experience and sound engineering practice.

11.3.1.4 Sling Care

Proper care and usage are essential for maximum service and safety. Wire-rope slings shall be protected from sharp bends and cutting edges by means of corner saddles, burlap padding, or wood blocking. Overloading shall be avoided, as shall sudden dynamic loading that can build up a momentary overload sufficient to break the sling.

11.3.1.5 Sling Storage

Personnel using slings shall ensure that they are stored properly as follows:

- a. Slings should be stored in racks (preferably vertical) and in designated locations when not in use. Do not store slings in a location where they will be subjected to mechanical damage, corrosive action, moisture, extreme heat, or kinking. Slings may require segregated storage as determined on a case-by-case basis.
- b. Before storage and periodically during storage, wipe slings clean to remove as much dirt and abrasive grit as possible and relubricate wire rope and chain slings to extend their useful life. Chains should not be lubricated when in use.
- c. Do not store metal-mesh slings in areas where the temperature exceeds 550 degrees F (288 degrees C) or 200 degrees F (93 degrees C) if elastomer covered.
- d. Do not store synthetic-web slings where the temperature exceeds 200 degrees F (93 degrees C).

11.3.2 Wire-Rope Slings

a. In general, wire-rope slings are made up of 6×19 or 6×37 classification wire rope. Rotation-resistant wire rope shall not be used for wire-rope slings. Different kinds of slings have been developed for specific purposes. These are divided into different groups or types as follows:

1. Endless-loop slings (grommet construction) and single-part slings with single-rope legs, double-rope legs, or multiple-part rope legs.
2. Two-leg bridle slings with single-rope legs, equalizing double-rope legs, or multiple-part rope legs.
3. Three-leg bridle slings.
4. Four-leg bridle slings.
5. Special slings and combinations.

b. The total load that can be safely lifted with slings depends on the rating of the slings and the manner in which they are attached to the load. Consult (load) Tables 11-4 through 11-9 and Figure 11-10.

c. Braided slings are made by braiding ordinary wire ropes together, thus making them more flexible than wire-rope slings. The size of a braided sling is determined by the diameter of one wire rope and the number of ropes in the cross section of the sling.

d. The design factor for wire-rope slings shall be a minimum of 5:1 based upon breaking strength.

e. When a wire rope sling is used in a choker hitch, the normal angle formed in the rope body as it passes through the choking eye is 120 degrees or greater [do not confuse the choke angle with the angle of inclination of the load (see Figure 11-10)]. Rated load in load capacity Tables 11-4 through 11-9 are for angles of 120 degrees or greater. For smaller angles, reduce the rated load to the percentages given in Figure 11-10.

When legs are not of equal length, use smallest H/L ratio

NOTE: Load may be supported on only 2 legs while 3rd leg balances it. Therefore, the required SWL is determined by the following:

$$\text{Total Rated Capacity} = \text{WLL (of single vertical hitch)} \times \text{H/L} \times 2$$

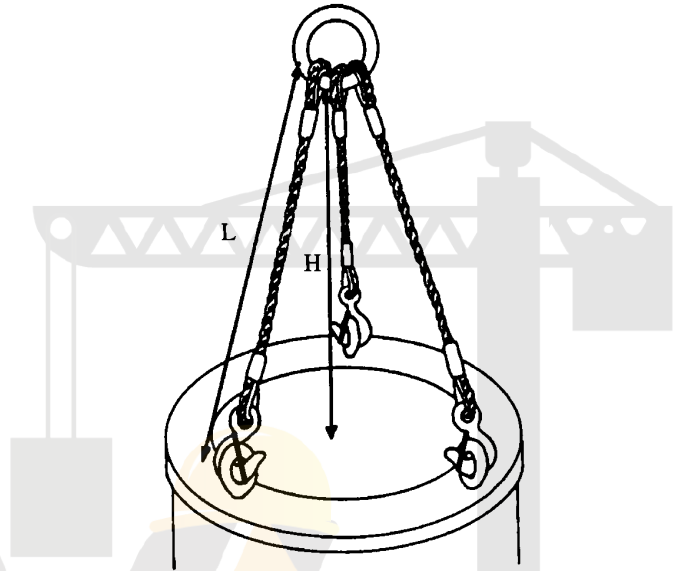

Figure 11-8. Determination of capacity—3-leg bridle sling.

When legs are not of equal length, use smallest H/L ratio.

NOTE: Load may be carried by only 2 legs while other 2 legs balance it. Therefore, the required SWL is determined by the following:

$$\text{Total Rated Capacity} = \text{WLL (of single vertical hitch)} \times \text{H/L} \times 2$$

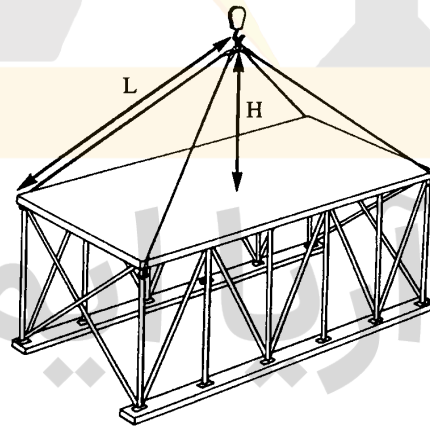



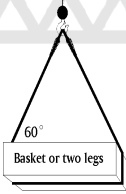
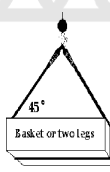



Figure 11-9. Determination of capacity—4-leg bridle sling.

**Table 11-4. Load capacity of wire-rope slings.
Hand tuck splice (IWRC) in pounds Design Factor = 5:1**

							
Dia. in inches	Vertical	Choker	Basket or two legs	Basket or two legs	Basket or two legs	Basket or two legs	Dia. in inches
1/4	1,100	820	2,200	1,800	1,500	1,100	1/4
5/16	1,600	1,280	3,200	2,800	2,200	1,600	5/16
3/8	2,400	1,840	4,800	4,000	3,200	2,400	3/8
7/16	3,000	2,400	6,000	5,400	4,400	3,000	7/16
1/2	4,000	3,200	8,000	6,800	5,600	4,000	1/2
9/16	5,000	4,000	10,000	8,600	7,000	5,000	9/16
5/8	6,000	5,000	12,000	10,400	8,400	6,000	5/8
3/4	8,400	7,200	16,800	14,600	11,800	8,400	3/4
7/8	11,000	9,600	22,000	19,200	15,600	11,000	7/8
1	14,000	12,600	28,000	24,000	20,000	14,000	1
1 1/8	18,000	15,800	36,000	32,000	26,000	18,000	1 1/8
*1 1/4	22,000	19,400	44,000	36,000	30,000	22,000	*1 1/4
*1 3/8	26,000	24,000	52,000	44,000	36,000	26,000	*1 3/8
*1 1/2	32,000	28,000	64,000	52,000	42,000	32,000	*1 1/2
*1 5/8	36,000	32,000	72,000	62,000	50,000	36,000	*1 5/8
*1 3/4	42,000	38,000	84,000	70,000	58,000	42,000	*1 3/4
*2	56,000	48,000	112,000	92,000	74,000	56,000	*2





Wire Rope/6 × 19 and *6 × 37 IPS IWRC

(CFR 1910.184/ANSI/ASME B30.9)

Notes:

- (1) These values only apply when the D/d ratio is 25 or greater (choker and basket hitches)
 - D = Diameter of curvature around which the body of the sling is bent
 - d = Diameter of rope
- (2) Choker hitch values apply only to choke angles greater than 120 degrees.

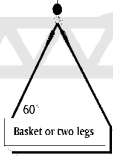
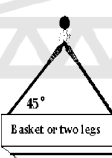
Table 11-5. Load capacity of wire-rope slings.
Hand tuck splice (Fiber Core) in pounds Design Factor = 5:1

Dia. in inches	 Vertical	 Choker	 Basket or two legs	 60° Basket or two legs	 45° Basket or two legs	 30° Basket or two legs	Dia. in inches
1/4	980	760	1,960	1,700	1,400	980	1/4
5/16	1,500	1,200	3,040	2,600	2,200	1,500	5/16
3/8	2,200	1,700	4,400	3,600	3,000	2,200	3/8
7/16	2,800	2,400	5,600	5,000	4,000	2,800	7/16
1/2	3,600	3,000	7,200	6,400	5,200	3,600	1/2
9/16	4,600	3,800	9,200	8,000	6,400	4,600	9/16
5/8	5,600	4,600	11,200	9,600	8,000	5,600	5/8
3/4	7,800	6,600	15,600	13,600	11,000	7,800	3/4
7/8	10,400	9,000	20,800	17,800	14,600	10,400	7/8
1	13,400	11,800	26,800	22,000	18,800	13,400	1
1 1/8	16,800	14,800	33,600	28,000	24,000	16,800	1 1/8
*1 1/4	20,000	18,000	40,000	34,000	28,000	20,000	*1 1/4
*1 3/8	24,000	22,000	48,000	42,000	34,000	24,000	*1 3/8
*1 1/2	30,000	26,000	60,000	52,000	42,000	30,000	*1 1/2
*1 5/8	34,000	30,000	68,000	58,000	48,000	34,000	*1 5/8
*1 3/4	40,000	34,000	80,000	70,000	56,000	40,000	*1 3/4
*2	52,000	44,000	104,000	90,000	74,000	52,000	*2
Wire Rope/6 × 19 and *6 × 37 IPS FC							

(CFR 1910.184/ANSI/ASME B30.9)

Notes:

- (1) These values only apply when the D/d ratio is 25 or greater (choker and basket hitches)
D = Diameter of curvature around which the body of the sling is bent
d = Diameter of rope
- (2) Choker hitch values apply only to choke angles greater than 120 degrees.

**Table 11-6. Load capacity of wire-rope slings.
Mechanical splice (IWRC) in pounds Design Factor = 5:1**





Dia. in inches	Vertical	Choker	Basket or two legs	Basket or two legs	Basket or two legs	Dia. in inches
1/4	1,100	840	2,200	1,940	1,580	1/4
5/16	1,700	1,300	3,400	3,000	2,400	5/16
3/8	2,400	1,860	4,800	4,200	3,600	3/8
7/16	3,400	2,500	3,800	5,800	4,800	7/16
1/2	4,400	3,200	8,800	7,600	6,200	1/2
9/16	5,500	4,200	11,000	9,600	7,700	9/16
5/8	6,800	5,000	13,600	11,800	9,600	5/8
3/4	9,700	7,200	19,400	16,800	13,600	3/4
7/8	13,000	9,800	26,000	22,000	18,300	7/8
1	17,000	12,800	34,000	30,000	24,000	1
1 1/8	20,000	15,600	40,000	36,000	30,000	1 1/8
*1 1/4	25,000	18,400	50,000	42,000	34,000	*1 1/4
*1 3/8	30,000	24,000	60,000	52,000	42,000	*1 3/8
*1 1/2	36,000	28,000	72,000	64,000	50,000	*1 1/2
*1 5/8	42,000	32,000	84,000	70,000	58,000	*1 5/8
*1 3/4	50,000	38,000	100,000	82,000	66,000	*1 3/4
*2	64,000	48,000	128,000	106,000	86,000	*2

(CFR 1910.184/ANSI/ASME B30.9)

Notes:

- (1) These values only apply when the D/d ratio is 25 or greater (choker and basket hitches)
 D = Diameter of curvature around which the body of the sling is bent
 d = Diameter of rope
- (2) Choker hitch values apply only to choke angles greater than 120 degrees.

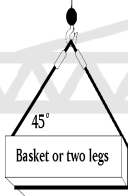
**Table 11-7. Load capacity of wire-rope slings.
8-part braided rope in pounds Design Factor = 5:1**

Dia. in inches	 Vertical	 Choker	 Basket or two legs	 45° Basket or two legs	 30° Basket or two legs	Dia. in inches
*1/8	1,900	1,400	3,200	2,600	1,900	*1/8
*3/16	4,200	3,000	7,200	5,800	4,200	*3/16
3/16	3,400	2,600	6,000	4,800	3,400	3/16
1/4	6,200	4,600	10,600	8,600	6,200	1/4
5/16	9,600	7,200	16,600	13,400	9,600	5/16
3/8	13,600	10,200	24,000	19,400	13,600	3/8
7/16	18,000	13,800	32,000	26,000	18,600	7/16
1/2	24,000	18,000	42,000	34,000	24,000	1/2
9/16	30,000	22,000	52,000	42,000	30,000	9/16
5/8	38,000	28,000	64,000	52,000	38,000	5/8
3/4	54,000	40,000	92,000	76,000	54,000	3/4
7/8	72,000	54,000	124,000	102,000	72,000	7/8
1	94,000	70,000	162,000	132,000	94,000	1





Wire Rope/6 × 19 IPS and *7 × 7 Galvanized Aircraft Grade

(CFR 1910.184/ANSI/ASME B30.9)

Notes:

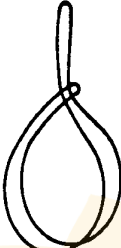
- (1) These values only apply when the D/d ratio is 25 or greater (choker and basket hitches)
 D = Diameter of curvature around which the body of the sling is bent
 d = Diameter of rope
- (2) Choker hitch values apply only to choke angles greater than 120 degrees.

**Table 11-8. Load capacity of wire-rope slings.
Cable laid grommet-hand tucked in pounds Design Factor = 5:1**

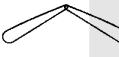
							
Dia. in inches	Vertical	Choker	Basket or two leg	60 degrees	45 degrees	30 degrees	Dia. in inches
*3/8	2,600	1,900	5,000	4,400	3,600	2,600	*3/8
*9/16	5,600	4,200	11,200	9,800	8,000	5,600	*9/16
*5/8	7,800	6,000	15,800	13,600	11,200	6,800	*5/8
3/4	10,200	7,600	20,000	17,600	14,400	10,200	3/4
15/16	15,800	11,800	32,000	28,000	22,000	15,800	15/16
1 1/8	22,000	16,800	44,000	38,000	32,000	22,000	1 1/8
1 5/16	30,000	22,000	60,000	52,000	42,000	30,000	1 5/16
1 1/2	38,000	28,000	78,000	66,000	54,000	38,000	1 1/2
1 11/16	48,000	36,000	98,000	84,000	68,000	48,000	1 11/16
1 7/8	60,000	44,000	120,000	104,000	84,000	60,000	1 7/8
2 1/4	84,000	62,000	168,000	146,000	118,000	84,000	2 1/4
2 5/8	112,000	84,000	224,000	194,000	158,000	112,000	2 5/8
3	144,000	108,000	286,000	248,000	202,000	144,000	3





Wire Rope/*7 × 6 × 7 and 7 × 6 × 19 IPS IWRC

(CFR 1910.184/ANSI/ASME B30.9)

Notes:

- (1) These values only apply when the D/d ratio is 10 or greater (choker and basket hitches)
D = Diameter of curvature around which the body of the sling is bent
d = Diameter of rope
- (2) Choker hitch values apply only to choke angles greater than 120 degrees.

**Table 11-9. Load capacity of wire-rope slings.
Strand laid grommet-hand tucked in pounds Design Factor = 5:1**

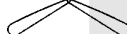
							
Dia. in inches	Vertical	Choker	Basket or two leg	60 degrees	45 degrees	30 degrees	Dia. in inches
1/4	1,840	1,320	3,600	3,200	2,600	1,840	1/4
3/8	4,000	3,000	8,000	7,000	5,800	4,000	3/8
1/2	7,000	5,200	14,000	12,200	10,000	7,000	1/2
5/8	10,800	8,000	22,000	18,800	15,200	10,800	5/8
3/4	15,200	11,400	30,000	26,000	22,000	15,200	3/4
7/8	20,000	15,200	40,000	34,000	28,000	20,000	7/8

آریا ایمن آوات

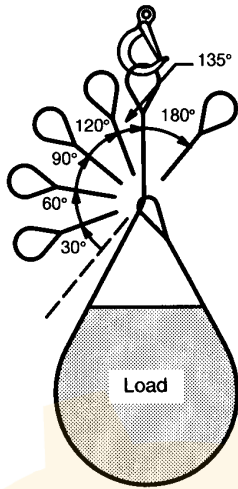

Angle of choke in degrees	Rated capacity IWRC and FC rope percent **
Over 120	100
90-120	87
60-89	74
30-59	62
0-29	49

**Percent of sling rated capacity in a choker hitch

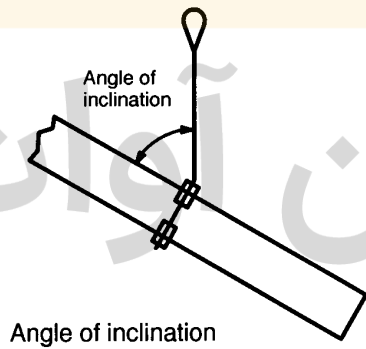
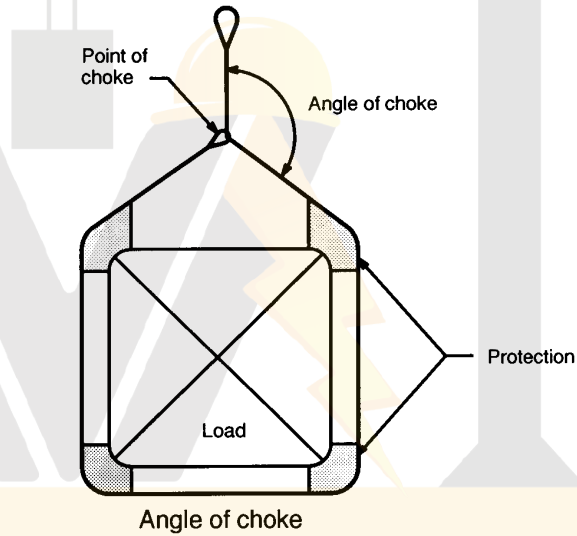
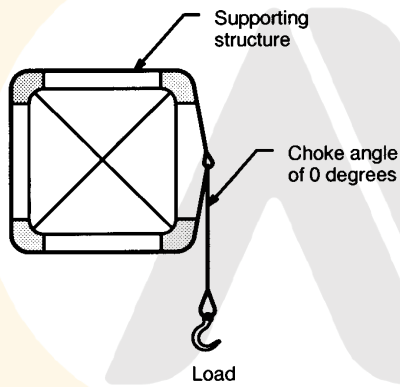

Figure 11-10. Choker hitch rated capacity adjustment.

11.3.2.1 Inspections

a. Wire-rope sling users shall visually inspect all slings each day they are used or prior to use if the sling has not been in regular service (records are not required). In addition, a periodic inspection (with records) shall be made at least annually by a qualified inspector. More frequent intervals should be established if necessary as determined by a qualified person based on:

1. Frequency of sling use.
2. Severity of service conditions.
3. Nature of lifts being made.
4. Experience gained on the service life of slings used in similar circumstances.

b. Users shall carefully note any deterioration that could result in an appreciable loss of original strength and determine whether further use of the sling would constitute a safety hazard.

c. A sample annual inspection form is included as Exhibit I at the end of this section. This form is intended to be a sample only and is not intended to be mandatory.

d. Inspection records shall be readily available.

e. Slings shall be immediately removed from service if any of the following conditions are present:

1. Ten randomly distributed broken wires in one rope lay or five broken wires in one strand in one rope lay.
2. Wear or scraping of one-third the original diameter of the outside individual wire.
3. Kinking, crushing, birdcaging, or any other damage resulting in distortion of the rope structure.
4. Evidence of heat damage.
5. End attachments that are cracked, deformed, or worn.
6. Corrosion of the rope or end attachments.

f. Hooks shall be inspected according to Chapter 12, "Rigging Accessories."

11.3.2.2 Proof-Testing

a. All swaged socket and poured socket sling assemblies shall be proof-tested to the wire rope or fitting manufacturers recommendations but in no case greater than 50 percent of the component wire ropes' or structural strands' nominal strength. All other sling assemblies shall be proof- tested when specified by the purchaser.

b. As a minimum, the proof load shall be equal to the rated capacity but shall not exceed:

1. 125 percent of the vertical rated capacity for single-leg, hand-tucked slings.
2. 200 percent of the vertical rated capacity for mechanical-splice single-leg slings and endless slings.

c. The proof- load for multiple-leg bridle slings assemblies shall be applied to the individual leg and shall be in accordance with paragraph a. and b. as applicable.

d. Master links to which multiple-leg slings are connected shall be proof-loaded to 200 percent times the force applied by the combined legs.

e. Welded end attachments shall not be used unless proof-tested at 2 times rated capacity prior to initial use.

f. Test loads described above shall be accurate to within -5 percent, +0 percent of stipulated values. A written letter of certification by the manufacturer or a pull test witnessed and certified in writing by a qualified person is acceptable.

11.3.2.3 Operation

a. The following shall apply to all personnel who use wire-rope slings:

1. Start and stop slowly; sudden starts and stops dramatically increase the stresses in hoist ropes and slings. Lift slowly until the load is suspended to minimize swinging.
2. Loads shall be set on blocks. Do not pull a sling from under a load that is resting on the sling.
3. Ensure that wire-rope slings are protected against weather, chemicals, solvents, and high temperatures.

DOE-STD-1090-2001

4. Permanently remove from service fiber-core rope slings that have been exposed to temperatures in excess of 180 degrees F (82 degrees C).

5. Obtain the manufacturer's written approval for use of wire rope slings of any grade at temperatures between 400 degrees F (204 degrees C) and -60 degrees F (-51 degrees C).

6. Extremely low temperatures (less than 0 degrees F) may cause brittle fractures. Under these conditions, sudden loading should be avoided and the rope should be carefully observed while the load is being applied.

7. Do not use knotted slings.

8. Do not use single-leg wire-rope slings unless proper precautions are taken to prevent suspended loads from rotating.

9. Rigging shall be configured such that slings do not reeve or slip through the hook.

10. Do not make a complete turn of wire rope around the crane hook.

11. Use protector pads or blocking at sharp corners.

12. Keep hands and fingers out of the area between the sling and the load.

13. Ensure that the weight of the load is within the rated capacity of the sling.

14. Do not use damaged slings.

15. Ensure that all personnel stand clear of the suspended load.

16. Avoid shock loading.

17. In a basket hitch, ensure that the load is balanced to prevent slippage.

18. Avoid handling hot material with wire-rope slings.

19. Use shackles or adjustable choker hooks when making choker hitches.

20. Store slings on racks away from moisture and acids when not in use.

21. Ensure that damaged wire-rope slings are rendered unusable, removed from service, discarded, and replaced with new slings.

22. Before use and before storage, check wire-rope slings for:

- i. Broken or cut wires or strands.
- ii. Rust or corrosion.
- iii. Kinks.
- iv. Broken seizing wire.
- v. Damage to swaged fittings.
- vi. Other signs of damage or abuse.

23. The capacity of wire-rope slings is derated by the manufacturer by applying the efficiency factors such as those given in Figure 11-11.

24. Do not use wire-rope clips to fabricate wire-rope slings except where the application of slings prevents the use of prefabricated slings or where the specific application is designed by a qualified person. Slings made with wire rope clips should not be used as a choker hitch (see Figures 11-12 and 11-13).

25. When wire-rope clips are used, the rating of the sling must be derated to 80 percent of the wire-rope rating to allow for the inefficiency of the clips.

26. Double-saddle clips or fist-grip clips (Figure 11-14) may be used to make up general-purpose slings provided the sling is derated to 95 percent of wire-rope capacity.

27. Follow the requirements of 29 CFR 1926.251, Table H-20 or the manufacturer's recommendation (whichever offers the greater protection) for the number of clips required, correct spacing, and torque. After the initial load is applied to the rope, retighten the clip nuts to the recommended torque to compensate for any decrease in rope diameter caused by the load. Rope clip nuts should be retightened to the recommended torque periodically to compensate for further decrease in rope diameter during usage.

Figure 11-11. Wire-rope fastenings.

Efficiencies of wire rope fittings or fastenings in percentages of strength of rope:

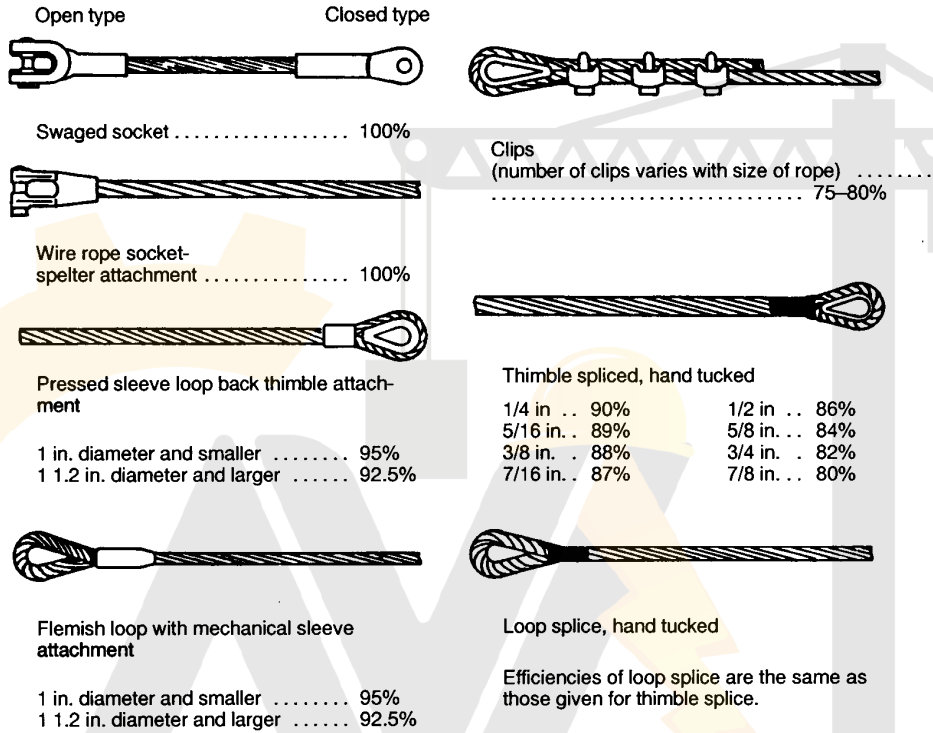

Note that the base of the clip bears against the live end of the wire rope, while the "U" of the bolt presses against the dead end.

Figure 11-12. Wire-rope clips—right way.

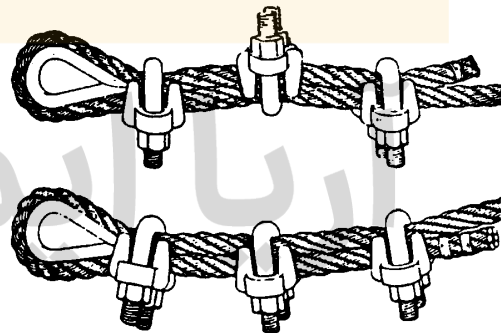

The "U" of the clips should not bear against the live end of the wire rope because of the possibility of the rope being kinked or crushed.

Figure 11-13. Wire-rope clips—wrong way.

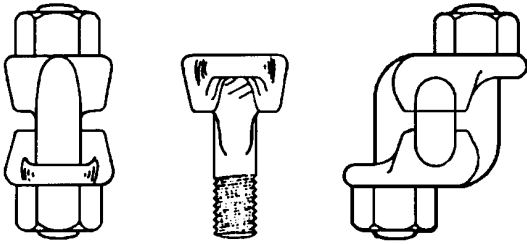

Figure 11-14. Double-saddle clips (drop-forged steel, galvanized).

28. As a minimum, mark wire-rope slings with the rated capacity and inspection due date. This information may be stenciled or stamped on a metal tag affixed to the sling. (Stenciling or stamping on the swages of a sling eye is not recommended.)

29. Slings made of rope with 6×19 and 6×37 construction and cable-laid slings shall have a minimum clear length of rope 10 times the rope diameter between splices, sleeves, or end fittings.

30. Braided slings shall have a minimum clear length of rope 40 times the component (individual) rope diameter between the loops or end fittings.

31. Grommets and endless slings shall have a minimum circumferential length of 96 times the body diameter of the grommet or endless sling.

11.3.2.4 Critical Lifts

See Chapter 2, "Critical Lifts," for critical lift requirements.

1. All provisions of paragraph 11.3.2.3.a, also shall apply to critical lifts.

2. Wire-rope slings used for critical-lift service shall have an initial proof load test. If proof testing cannot be verified, the wire-rope sling(s) shall be proof tested before being used to make a critical lift. As a minimum, the proof load shall be equal to the rated capacity but shall not exceed:

- i. All swaged socket and poured socket sling assemblies shall be proof-tested to the wire rope or fitting manufacturers recommendations but in no case greater than 50 percent of the

- ii. component wire ropes' or structural strands' nominal strength.
- ii. 125 percent of the vertical rated capacity of single-leg, hand-tucked slings.
- iii. 200 percent of the vertical rated capacity for mechanical-spliced single-leg slings and endless slings.

iv. The proof-load for multiple-leg bridle slings assemblies shall be applied to the individual leg and shall be in accordance with paragraph i, ii., and iii. as applicable.

v. Master links to which multiple-leg slings are connected shall be proof-loaded to 200 percent times the force applied by the combined legs.

vi. Test weights shall be accurate to within -5 percent, +0 percent of stipulated values.

3. Wire-rope sling eyes with thimbles shall be made with a thimble having a ratio of thimble diameter (D) to rope diameter (d) of 3 or more (D/d greater than or equal 3).

4. Do not use wedge sockets or wire-rope clips on slings used for critical lifts.

5. Ensure that working loads of wire-rope slings do not exceed their rated capacities.

6. Do not splice slings together.

7. Use thimble eyes for slings to be joined end-to-end.

8. Locate sling eyes so that:

- i. Adequate clearance is maintained between the attached slings and other parts or surfaces of the component or equipment.
- ii. There is no interference with the functioning of hoisting, rigging, or handling equipment.
- iii. Maximum accessibility to the eye is maintained.

- iv. Attached slings can converge over the center of gravity of the lift.
- v. Proper stability can be maintained during lifting and positioning of the item at the installation site.
- vi. The plane of the slinging eye is coincident with the plane of the sling under loaded conditions within ± 5 degrees.
- vii. Sling angles are not less than 45 degrees with the horizontal.

9. In addition to marking requirements listed for ordinary lifts, other items may need to be marked as determined on a case-by-case basis, such as the reach, type, weight of the sling assembly, and rated capacity.

11.3.3 Alloy Steel-Chain Slings

a. This section applies to slings made from grade 80 alloy chain manufactured and tested in accordance with National Association of Chain Manufacturers welded steel chain specifications—1990. If chain other than this is used, it shall be used in accordance with the recommendations of the chain manufacturer.

b. Alloy Steel-chain slings differ from wire-rope slings in that components using wire are replaced by link chain. Other sling components are similar. Chain slings are more rugged and flexible, but less shock resistant than wire-rope or braided slings. The size is measured by the link stock.

c. Two basic types with many variations are used: basket type and hook type. An example of each is shown in Figure 11-15.



Double-basket type

Hook type

Figure 11-15. Types of chain slings.

d. Alloy-steel-chain slings shall not be heated above 1,000 degrees F (537 degrees C) after being received from the manufacturer.

e. When exposed to service temperatures in excess of 600 degrees F (315 degrees C), reduce working load limits in accordance with the chain manufacturer's recommendations.

f. Extremely low temperatures (less than 0 degrees F) may cause brittle fractures. Under these conditions, sudden loading should be avoided and the load should be lifted a very short distance while the chains are carefully inspected.

g. The design factor for steel-chain slings shall be a minimum of 4:1 based upon breaking strength.

h. Chains should be stored in racks or in designated locations when not in use. Chains should never be stored in damp or dirty places, nor in places exposed to the weather. For long-term storage, they should receive a coating of oil. The ends of all empty chains should be hooked onto the hoist hook or bull ring.

i. Chains should not be lubricated when in use because this might make them dangerous to handle. Chains should be cleaned periodically to remove abrasive grit and to facilitate inspection.

j. The total load that can be lifted safely with steel-chain slings depends on the manner by which the slings are attached to the load. If all legs of a steel-chain sling are hooked back into the master link, the safe-load capacity of the whole sling may be increased by 100 percent if the capacity of the master link is not exceeded.

k. The safe-load level of any chain sling is a function of three basic factors: size and number of legs, condition of chain and other components, and sling angle between legs and horizontal. Table 11-10 shows safe loads in pounds per leg which can be carried by various chain-sling arrangements. Note the effect of very low hook height and wide leg spreads.

l. *Attachments:* Hooks, rings, oblong links, pear shaped links, welded or mechanical coupling links and other attachments shall have a rated capacity at least equal to that of the alloy steel chain with which they are used or the sling shall not be used in excess of the rated capacity of the weakest component.

11.3.3.1 Pre-Use Inspections

Steel-chain sling users shall visually inspect all slings before they are used as follows:

- a. Conduct a link-by-link inspection for the following defects: bent links, stretched links, cracks in any section of link, scores, abrasions, heat damage, or markings tending to weaken the links. Reject if discovered.
- b. Check rings and hooks for distortion, cracks in weld areas, corrosion, and scores, heat damage, or markings tending to weaken the links. Reject if discovered.
- c. Perform inspection on an individual-link basis. If any link does not hinge freely with the adjoining link, remove the assembly from service.
- d. Remove from service assemblies with deformed master links or coupling links.
- e. Remove from service assemblies if hooks have been opened more than 15 percent of the normal throat opening measured at the narrowest point or twisted more than 10 degrees from the plane of the unbent hook.
- f. Do not straighten deformed hooks or other attachments on the job. Assemblies with such defects shall be reconditioned by the manufacturer or discarded.
- g. Remove from service assemblies with cracked hooks or other end attachments; assemblies with such defects shall be reconditioned or repaired prior to return to service.

11.3.3.2 Annual Inspections

- a. A sample annual inspection form is included as Exhibit II at the end of this section. This form is intended to be a sample only and is not intended to be mandatory.
- b. Annual inspections shall be conducted by a qualified inspector. In addition to criteria for daily inspections, the qualified inspector shall do the following for annual inspections:

1. Hang chain in a vertical position, if practicable, for preliminary inspection. Chain should hang reasonably straight if links are not distorted.

2. Accurately measure the reach (inside of crane ring to inside of hook) under no load when new and at each inspection, and keep a record of increase in length; an increase in length may be due to stretch (sign of overload or wear).

3. Check for localized stretch and wear. Lift each link from its seat and visually inspect for grooving. If grooving is noticed, verify stock diameter of link to be within the minimum safe dimensions in the table below. Reject chain if it does not meet the requirements in the table.

4. Remove the assembly from service if wear at any point of any chain link exceeds that shown in Table 11-11.

5. Round out sharp transverse nicks by grinding. If the minimum dimensions are reduced below those values specified in Table 11-11, remove the assembly from service.

6. Check for evidence of heat damage.

11.3.3.3 Proof-Testing





- a. Single-leg and endless alloy-steel chain slings shall be certified as having been proof-tested to 200 percent of the rated capacity prior to initial use.

- b. The proof load for multiple-leg bridle slings shall be applied to the individual legs and shall be 200 percent of the vertical rated capacity of a single-leg sling.

- c. Master links to which multiple-leg slings are connected shall be proof-loaded to 200 percent multiplied by the force applied by the combined legs.

- d. Test loads shall be accurate to within -5 percent, +0 percent of stipulated values. Either certification by the manufacturer or a pull test certified by a qualified person is acceptable.

Table 11-10. Alloy steel chain slings in pounds Design Factor = 4:1

Size in inches	 Single Leg	 60° Two Legs	 45° Two Legs	 30° Two Legs	Size in inches
9/32	3,500	6,100	4,900	3,500	9/32
3/8	7,100	12,300	10,000	7,100	3/8
1/2	12,000	20,800	17,000	12,000	1/2
5/8	18,100	31,300	25,600	18,100	5/8
3/4	28,300	49,000	40,000	28,300	3/4
7/8	34,200	59,200	48,400	34,200	7/8
1	47,700	82,600	67,400	47,700	1
1 1/4	72,300	125,200	102,200	72,500	1 1/4

(CFR 1910.184/ANSI/ASME B30.9)

Notes:

- (1) Other grades of proof tested steel chain include Proof Coil (Grade 28), Hi-Test (Grade 43) Chain and Transport (Grade 70) Chain. These grades are not recommended for overhead lifting and therefore are not covered in the applicable standards.
- (2) Rating of multileg slings adjusted for angle of loading between the inclined leg and the horizontal plane of the load.

آریا ایمن آوات

Table 11-11. Maximum allowable wear of chains.

Chain size (in.)	Maximum allowable wear (in.)
1/4	3/64
3/8	5/64
1/2	7/64
5/8	9/64
3/4	10/64
7/8	11/64
1	12/64
1-1/4	16/64

NOTE: For other sizes, consult chain or sling manufacturer.

11.3.3.4 Operation

a. The following shall apply to all personnel who use steel-chain slings:

1. Do not set a load on a sling or pull a sling from under a load. Place wooden blocks or other supports under the load to provide sufficient clearance for the chain.

2. Shorten chain slings by hooking back into the chain, into the master link, or with grab hooks. Do not shorten by knotting, twisting, bolting, or inserting the tip of the hook into a link.

3. Do not hammer a chain to force it into position.

4. Protect chain slings from sharp corners that might bend the links. Use a suitable pad to prevent gouging or bending of the chain links, as well as possible scarring of the load.

5. When making choker hitches with chain slings, always face the hook opening out and away from the pull of the sling so that the hooks will not slip out when slack is taken out of the sling.

6. Check steel-chain slings for:

- i. Nicks, cracks, gouges, and wear.
- ii. Bending, stretching, or shearing of links.
- iii. Bends or distortions in hooks.

iv. Rust and corrosion.

v. Uneven lengths when sling legs are hanging free.

vi. Evidence of heat damage.

7. Do not weld or perform local repairs on chain slings. All defective chain slings should be returned, through a formal procedure, to the manufacturer for examination, repair, and recertification.

8. Avoid sudden loading of chain slings.

9. Maintain latches on hooks in good condition.

10. If a chain sling does not look safe, do not use it. Do not assume that a chain sling is safe because it looks new; look for stretched links. If in doubt, check with the supervisor.

11. Do not carry loads on the point or tip of a hook.

12. Avoid unbalanced loads.

13. Do not use homemade links, makeshift fasteners formed from bolts, rods, and the like, or other nonstandard attachments.

14. Do not use makeshift or field-fabricated hooks on steel-chain slings.

15. Hook the ends of all empty chain onto the hoist hook or bull ring.

16. Ensure that steel-chain slings used in DOE-controlled areas are marked, at a minimum, with:

- i. Size.
- ii. Manufacturer's grade.
- iii. Rated load and angle on which the rating is based.
- iv. Reach.
- v. Number of legs.
- vi. Sling manufacturer.
- vii. Inspection due date.

17. This information may be stenciled or stamped on a metal tag or tags affixed to the sling.

18. Where slings have more than one leg, ensure that the tag is affixed to the master link.

19. Ensure that the working load does not exceed the rated capacity of the sling.

11.3.3.5 Critical Lifts

See Chapter 2, “Critical Lifts,” for critical lift requirements.

a. Single-leg and endless alloy-steel chain slings used for critical-lift service shall have an initial proof load test of 200 percent of the vertical rated capacity. If proof testing cannot be verified, the sling(s) shall be proof tested before being used to make a critical lift.

b. The proof load for multiple-leg bridle slings shall be applied to the individual legs and shall be 200 percent of the vertical rated capacity of a single-leg sling.

c. Master links to which multiple-leg slings are connected shall be proof-loaded to 200 percent multiplied by the force applied by the combined legs.

11.3.4 Metal-Mesh Slings

a. Metal-mesh slings (Figure 11-16) shall be classified with the designations shown in Table 11-12, based on types of duty and material classification.

Table 11-12. Metal-mesh sling designations.

Type Designation	Classification	
Heavy duty	Carbon steel	35-CS
	Stainless steel	35-SS
Medium duty	Carbon steel	43-CS
	Stainless steel	43-SS
Light duty	Carbon steel	59-CS
	Stainless steel	59-SS

b. The carbon steel used in metal-mesh slings shall be processed to produce the required mechanical properties.

c. The material used for stainless-steel metal-mesh slings shall conform, at least, to the American Iron and Steel Institute standards for Type-302 or Type-304 stainless steel. Other materials may be used. When metal-mesh slings are produced from such materials, however, the sling manufacturer should be consulted for specific data.

d. The handle shall be designed to ensure:

1. At least the same rated capacity as the fabric.

2. No visible permanent deformation after proof-testing.

e. The fabric and handles shall be so joined that:

1. The rated capacity of the sling is not reduced.

2. The load is evenly distributed across the width of the fabric.

3. Sharp edges do not damage the fabric.

f. Metal-mesh slings may be painted, plated, impregnated with elastomers such as neoprene or polyvinyl chloride (PVC), or otherwise suitably coated. The coating shall not diminish the rated capacity of a sling.

g. The design factor for metal-mesh slings shall be a minimum of 5:1 based upon breaking strength.

h. Metal-mesh slings shall not be used to lift loads greater than the rated capacity, properly derated for other than straight-pull configurations (Table 11-13).

i. Except for elastomer-impregnated slings, all metal-mesh slings covered by this section may be used without derating in a temperature range from -20 degrees F (-29 degrees C) to 550 degrees F (288 degrees C).

j. All metal-mesh slings covered by this section and impregnated with PVC or neoprene shall be used only in a temperature range from 0 degrees F (-18 degrees C) to 200 degrees F (93 degrees C).

k. For operation at temperatures outside these ranges or for other impregnations, consult the manufacturer for specific data.

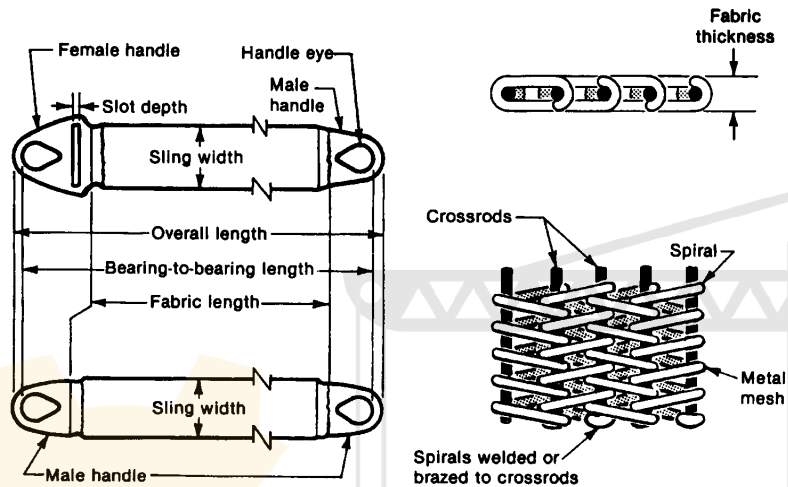

Figure 11-16. Typical metal-mesh sling.

11.3.4.1 Inspections

a. Users of metal-mesh sling shall visually inspect all metal-mesh slings before each use.

b. Annual inspections shall be made by a qualified inspector, and inspection records shall be kept on file and be readily available.

c. Metal-mesh slings shall be removed from service if any of the following defects are present:

1. A broken weld or brazed joint along the sling edge.
2. A broken wire in any part of the mesh.
3. Reduction in wire diameter of 25 percent due to abrasion or 15 percent due to corrosion.
4. Lack of flexibility due to distortion of the mesh.
5. Distortion of the female handle so the depth of the slot is increased by more than 10 percent.

6. Distortion of either end fitting so the width of the eye opening is decreased by more than 10 percent.

7. A 15 percent reduction of the original cross-sectional area of metal at any point around a handle eye.

8. Any distortion or twisting of either end fitting out of its plane.

9. Cracked end fitting.

10. Evidence of heat damage.



11.3.4.2 Proof-Testing

a. Metal-mesh slings shall be certified as having been proof-tested to 200 percent of their rated capacity prior to initial use.

b. Coated slings shall be proof-tested prior to being coated.

c. Test loads shall be accurate to within -5 percent, +0 percent of stipulated values. Either certification by the manufacturer or a pull test certified by a qualified person is acceptable.

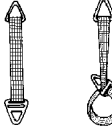
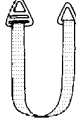
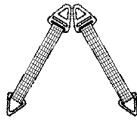
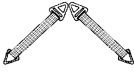
**Table 11-13. Load capacity of carbon and stainless-steel metal-mesh slings in pounds
Design Factor = 5:1**

Sling width(in.)	 Vertical or choker	 Basket or two legs	 60° Basket or two legs	 45° Basket or two legs	 30° Basket or two legs	Sling width(in.)
Heavy duty 10-ga 35 spirals/ft of mesh width						
2	1,500	3,000	2,600	2,100	1,500	2
3	2,700	5,400	4,700	3,800	2,700	3
4	4,000	8,000	6,900	5,600	4,000	4
6	6,000	12,000	10,400	8,400	6,000	6
8	8,000	16,000	13,800	11,300	8,000	8
10	10,000	20,000	17,000	14,100	10,000	10
12	12,000	24,000	20,700	16,900	12,000	12
14	14,000	28,000	24,200	19,700	14,000	14
16	16,000	32,000	27,700	22,600	16,000	16
Medium duty 12-ga 43 spirals/ft of mesh width						
2	1,350	2,700	2,300	1,900	1,400	2
3	2,000	4,000	3,500	2,800	2,000	3
4	2,700	5,400	4,700	3,800	2,700	4
6	4,500	9,000	7,800	6,400	4,500	6
8	6,000	12,000	10,400	8,500	6,000	8
10	7,500	15,000	13,000	10,600	7,500	10
12	9,000	18,000	15,600	12,700	9,000	12
14	10,500	21,000	18,200	14,800	10,500	14
16	12,000	24,000	20,800	17,000	12,000	16
Light duty 14-ga 59 spirals/ft of mesh width						
2	900	1,800	1,600	1,300	900	2
3	1,400	2,800	2,400	2,000	1,400	3
4	2,000	4,000	3,500	2,800	2,000	4
6	3,000	6,000	5,200	4,200	3,000	6
8	4,000	8,000	6,900	5,700	4,000	8
10	5,000	10,000	8,600	7,100	5,000	10
12	6,000	12,000	10,400	8,500	6,000	12
14	7,000	14,000	12,100	9,900	7,000	14
16	8,000	16,000	13,900	11,300	8,000	16

(CFR 1910.184/ANSI/ASME B30.9)

11.3.4.3 Operation

- a. The following shall apply to all personnel who use metal-mesh slings:
 - 1. Ensure that the weight of the load is within the rated capacity of the sling.
 - 2. Ensure that metal-mesh slings have suitable characteristics and rated capacity for the load and environment.
- b. Metal-mesh slings should be long enough to provide the maximum practical angle between the sling leg and the horizontal (minimum practical angle at the crane hook if vertical angles are used).
- c. Do not shorten metal-mesh slings with knots, bolts, or other unapproved methods.
- d. Do not use damaged slings.
- e. Securely hitch metal-mesh slings to the load.
- f. Ensure that sharp corners are padded.
- g. Keep hands and fingers out of the area between the sling and the load.
- h. Ensure that all personnel stand clear of the suspended load.
- i. Avoid shock loading.
- j. Do not pull metal-mesh slings from under a load when the load is resting on the sling.
- k. Do not store metal-mesh slings in an area where they will be subjected to mechanical damage or corrosive action.
- l. Avoid twisting and kinking of the legs.
- m. In a choker hitch, ensure that metal-mesh slings are long enough so that the female handle chokes freely on the mesh, never on the handle.
- n. In a choker hitch, ensure that the load is balanced. When this cannot be done, consult the manufacturer for a derating factor or for other means of handling this type of load.
- o. In a basket hitch, ensure that the load is balanced to prevent slippage.
- p. Do not use metal-mesh slings in which the spirals are locked or are without free articulation.
- q. Never hammer a sling to straighten a spiral or cross rod or to force a spiral into position.

r. Metal-mesh slings used in pairs should be attached to a spreader beam.

s. Ensure that all metal-mesh slings have a permanently affixed metal identification tag or tags containing the following information:

- 1. Manufacturer's name or trademark.
- 2. Rated load in vertical, basket, and choker hitches.
- 3. Inspection due date.

11.3.4.4 Critical Lifts

See Chapter 2, "Critical Lifts," for critical lift requirements.

- a. Metal-mesh slings used for critical-lift service shall have an initial proof load test of 200 percent of the vertical rated capacity. If proof testing cannot be verified, the sling(s) shall be proof tested before being used to make a critical lift.
- b. The proof load for multiple-leg bridle slings shall be applied to the individual legs and shall be 200 percent of the vertical rated capacity of a single-leg sling.
- c. Master links to which multiple-leg slings are connected shall be proof-loaded to 200 percent multiplied by the force applied by the combined legs.

11.3.5 Synthetic-Web Slings

a. Synthetic web shall possess the following qualities:

- 1. Be of sufficient strength to meet the sling manufacturer's requirements.
- 2. Have uniform thickness and width.
- 3. Have selvage edges and not be split from its woven width.

b. The thread used in the manufacture of a synthetic-web sling shall be of the same type of material as the web.

c. Fittings shall be:

- 1. Of sufficient strength to sustain twice the rated capacity without permanent deformation.
- 2. Of a minimum breaking strength equal to that of the sling.

3. Free of all sharp edges that would in any way damage the mesh.

d. The stitching in all load-bearing splices shall be of sufficient strength to maintain the sling design factor.

e. Synthetic-web slings may be coated with elastomers or other suitable material that will provide characteristics such as abrasion resistance, sealing of pores, and increased coefficient of friction.

f. The design factor for synthetic-web slings shall be a minimum of 5:1 based upon breaking strength.

g. Rated capacities are affected by the type of hitch used and by the angle from the vertical when used as multilegged slings or in basket hitches. The sling manufacturer shall supply data on these effects.

h. Synthetic-web slings are available in a number of configurations as follows (see Figure 11-17):

1. *Endless or Grommet Sling*—Both ends of one piece of webbing are lapped and sewn to form a continuous piece. They can be used as vertical hitches, bridle hitches, in choker arrangements, or as basket slings. Because load contact points can be shifted with every lift, wear is evenly distributed and sling life is extended.

2. *Standard Eye and Eye*—Webbing is assembled and sewn to form a flat-body sling with an eye at each end and the eye openings in the same plane as the sling body. The eyes may either be full web width or may be tapered by being folded and sewn to a width narrower than the webbing width.

3. *Twisted Eye*—An eye-and-eye type that has twisted terminations at both ends. The eye openings are at 90 degrees to the plane of the sling body. This configuration is also available with either full-width or tapered eyes.

i. In place of the sewn eyes, synthetic-web slings are also available with metal end fittings (see Figure 11-18). The most common are triangle and choker hardware. Combination hardware consists of a triangle for one end of the sling and a triangle/rectangle choker attachment for the other end. With this arrangement, both choker and basket hitches, as well as straight hitches, may be rigged. They help reduce wear in the sling eyes and thus lengthen sling life.

j. Despite their inherent toughness, synthetic-web slings can be cut by repeated use around sharp-cornered objects. They eventually show signs of abrasion when they are repeatedly used to hoist rough-surfaced products. There are, however, protective devices offered by most sling manufacturers that minimize these effects (see Figure 11-19). Other protective devices include:

1. Buffer strips of leather, nylon, or other materials that are sewn on the body of a sling protect against wear. Leather pads are the most resistant to wear and cutting, but are subject to weathering and gradual deterioration. They are not recommended in lengths over 6 ft due to the different stretching characteristics of leather and webbing. On the other hand, nylon-web wear pads are more resistant to weathering, oils, grease, and most alkalis; and they stretch in the same ratio as the sling body.

2. Edge guards consist of strips of webbing or leather sewn around each edge of the sling. This is necessary for certain applications where the sling edges are subject to damage.

3. Sleeve- or sliding-tube-type wear pads are available for slings used to handle material having sharp edges. They can be positioned on the sling where required, do not move when the sling stretches, adjust to the load, and cover both sides of the sling.

4. Reinforcing strips that double or triple the eye's thickness and greatly increase its life and safety can be sewn into the sling eyes.

5. Coatings can be applied to provide added resistance to abrasion and chemical damage. These treatments also increase the coefficient of friction, affording a better grip when loads with slippery surfaces are to be handled. These coatings can be brightly colored for safety or load-rating purposes.

6. Cotton-faced nylon webbing can be used for hoisting rough-surfaced material.

k. The synthetic-web sling capacities listed in Tables 11-14 and 11-15 are approximate only and are based on nylon webbing having breaking strengths between 6,000 and 9,000 lb/in. of webbing width. The capacities are also based on a 5:1 design factor and assume that the end fittings are of adequate strength.

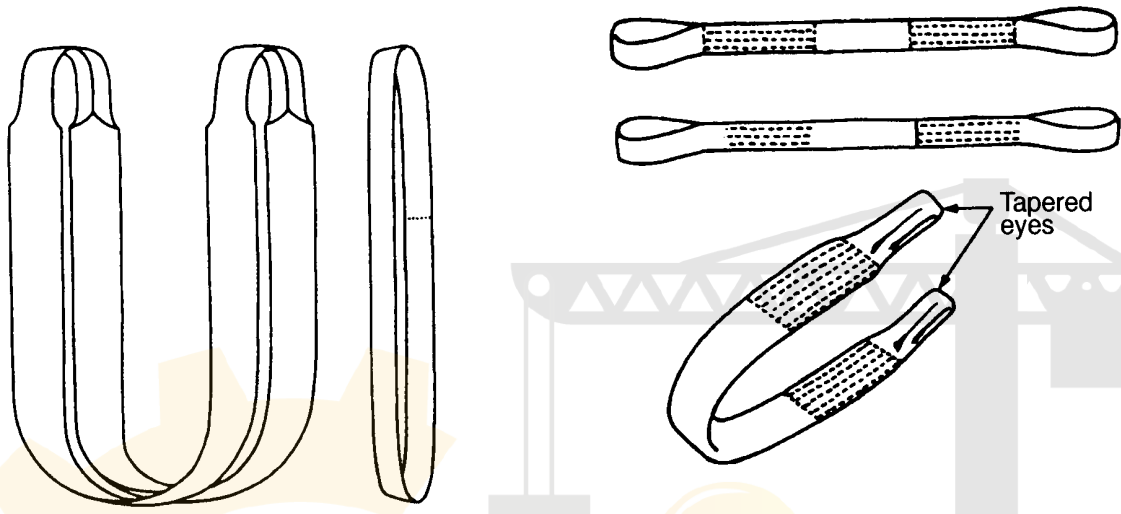

Endless or grommet slings

Standard eye-and-eye slings

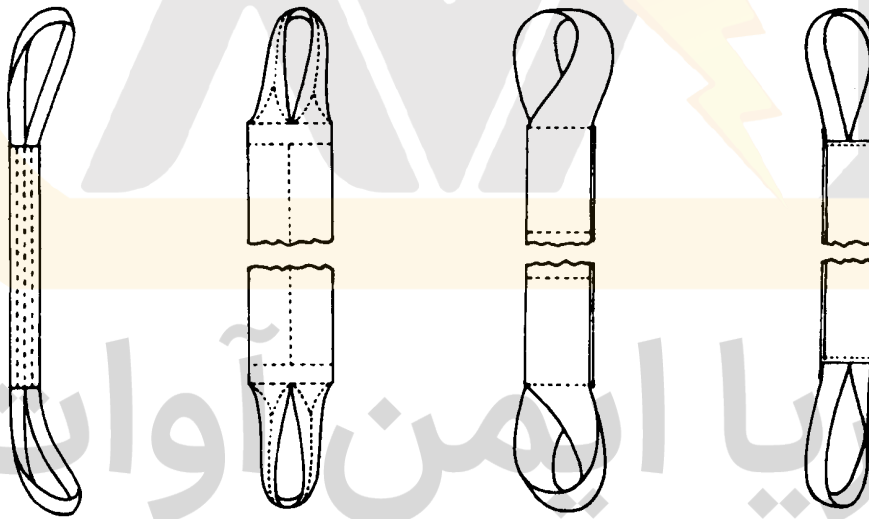

Twisted-eye slings

Figure 11-17. Synthetic-web sling types.

l. Although safe working loads for bridle hitches in the choker or double-basket configuration are provided, they should be used only with extreme caution because, as the sling angle decreases, one edge of the web will take all the load, producing a risk of tearing (see Figure 11-20).

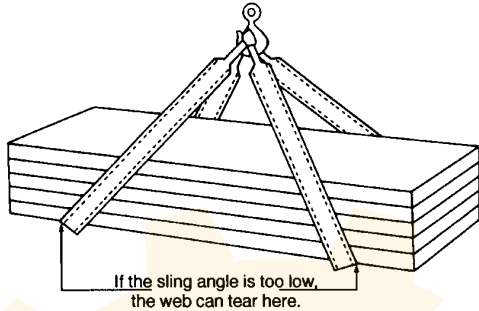

Figure 11-20. Effect of low sling angle.

m. Synthetic-web slings, other than those described in this section [i.e., polyester round and kevlar fiber (yarn) slings], shall be used in accordance with the sling manufacturer's recommendation.

n. Conventional three-strand natural or synthetic fiber rope slings are NOT recommended for lifting service and should be used only if conventional sling types are not suitable for a unique application. The requirements of ASME B30.9 ("Slings"), Section 9-4, and 29 CFR 1910.184(h) shall be followed.

CAUTION: Tiedown and/or ratchet strap shall not be used as synthetic-web slings. Only synthetic-web slings constructed from webbing approved for sling construction by the manufacturer or other qualified person shall be used at DOE locations.

11.3.5.1 Inspections

- a. Users of synthetic-web sling shall visually inspect all slings before each use.
- b. Annual inspection shall be made by a qualified inspector, and inspection records shall be kept on file and readily available.
- c. When it is necessary to use a nylon or polyester sling in a radiation area, the responsible manager shall ensure that radiation exposure does not exceed 100,000 rad during the life of the sling.

d. Slings shall be removed from service if any of the following defects are visible:

1. Acid or caustic burns.
2. Melting or charring of any part of the surface.
3. Snags, punctures, tears, or cuts.
4. Broken or worn stitches.
5. Wear or elongation exceeding the amount recommended by the manufacturer.
6. Distortion of fittings.
7. Knots in any part.
8. Missing or illegible sling identification.

A sample periodic inspection form is included as Exhibit III at the end of this section. This form is intended to be a sample only and is not intended to be mandatory.

11.3.5.2 Proof-Testing

- a. When specified by the purchaser, web slings of all types shall be certified as having been proof-tested prior to initial use.
 1. The proof load for single-leg slings and endless slings shall be 200 percent of the vertical rated capacity.
 2. The proof load for multiple-leg bridle slings shall be applied to the individual legs and shall be 200 percent of the vertical rated capacity of a single-leg sling. Master links to which multiple-leg slings are connected shall be proof-loaded to 200 percent times the force applied by the combined legs.
- b. Test loads shall be accurate to within -5 percent, +0 percent of stipulated values. Either certification by the manufacturer or a pull test certified by a qualified person is acceptable.

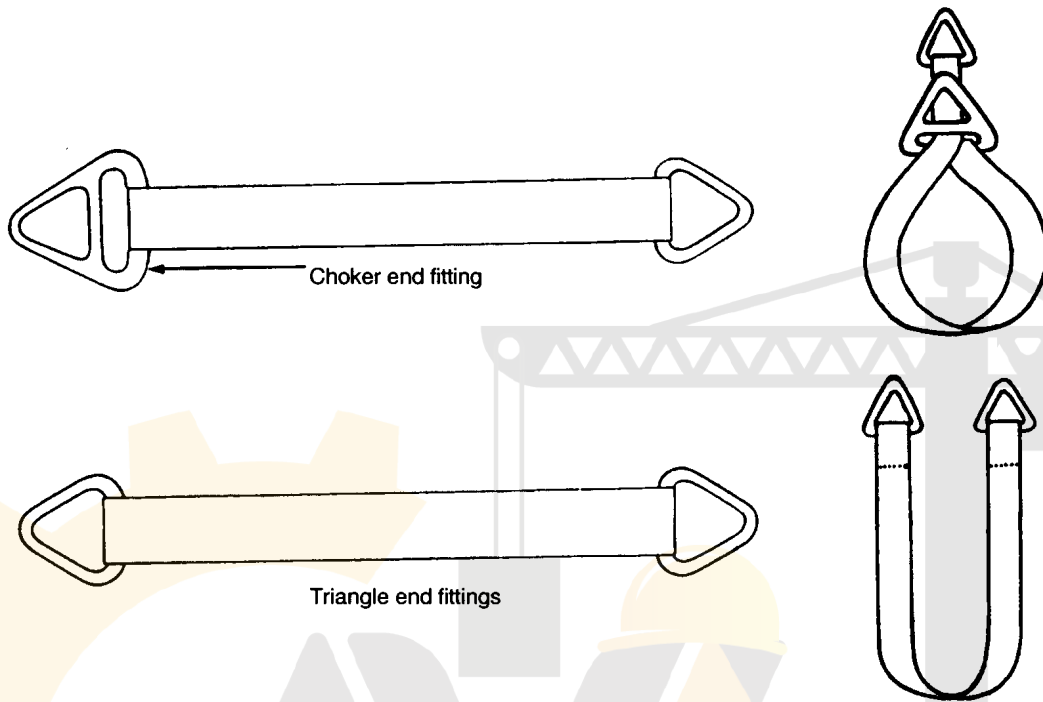
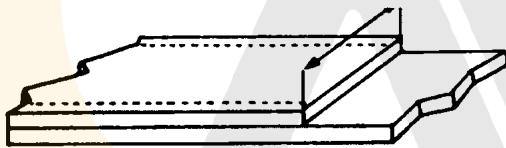
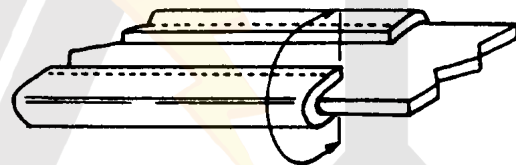

Figure 11-18. Metal end fittings.



REGULAR. This is the type of edge protection that is sewn on to give fixed protection at expected wear points. They can be sewn anywhere on the sling, at any length on one side, or on both sides.





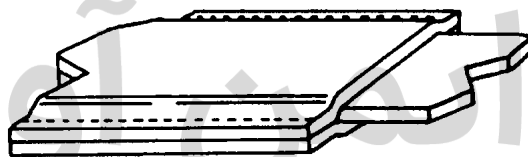

EDGE GUARD. A strip of webbing or leather is sewn around each edge of the sling. This is necessary for certain applications where the sling edges are subject to damage.



SLEEVE. Sometimes called sleeve or sliding-tube type wear pads, these pads are ideal for handling material with sharp edges because the sleeve does not move when the sling stretches and adjusts to the load. Sleeves cover both sides of the sling and can be shifted to points of expected maximum wear.

Figure 11-19. Web and edge protectors.

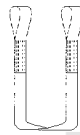
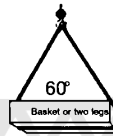
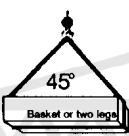
**Table 11-14. Load capacity of synthetic web slings in pounds Design Factor = 5:1
(eye and eye, twisted eye, triangle fittings, choker fittings)**





Web width (in.)	 Vertical	 Choker	 Basket or two legs	 60° Basket or two legs	 45° Basket or two legs	 30° Basket or two legs	Web width (in.)
Nylon Single Ply Web Slings (6,000 lb/in. material)							
1	1,200	900	2,400	2,080	1,700	1,200	1
2	2,400	1,800	4,800	4,160	3,400	2,400	2
3	3,600	2,700	7,200	6,240	5,100	3,600	3
4	4,800	3,600	9,600	8,300	6,800	4,800	4
5	6,000	4,500	12,000	10,400	8,500	6,000	5
6	7,200	5,400	14,400	12,500	10,200	7,200	6
Nylon Double Ply Web Slings (6,000 lb/in. material)							
1	2,400	1,800	4,800	5,600	3,400	2,400	1
2	4,800	3,600	9,600	8,320	6,800	4,800	2
3	7,200	5,400	14,400	12,480	10,200	7,200	3
4	9,600	7,200	19,200	16,600	13,600	9,600	4
5	12,000	9,000	24,000	20,800	17,000	12,000	5
6	14,400	10,800	28,800	25,000	20,400	14,400	6

(CFR 1910.184/ANSI/ASME B30.9)

- (1) For an endless sling with vertical hitch carrying a load of such size as to throw the legs more than 5 deg. off vertical use rated load data for eye and eye sling, basket hitch and corresponding leg angles.
- (2) Follow manufacturer's capacities, they vary from manufacturer to manufacturer.
- (3) Choker hitch values apply only to choke angles greater than 120 degrees.

آریا ایمن آوات

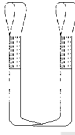
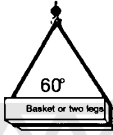
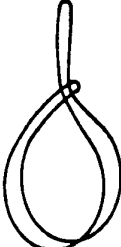
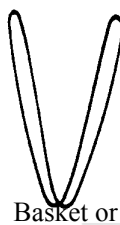

**Table 11-15. Load capacity of synthetic web slings in pounds Design Factor = 5:1
(eye and eye, twisted eye, triangle fittings, choker fittings)**

Web width (in.)	 Vertical	 Choker	 Basket or two legs	 60° Basket or two legs	 45° Basket or two legs	 30° Basket or two legs	Web width (in.)
Nylon Single Ply Web Slings (9,000 lb/in. material)							
1	1,600	1,280	3,200	2,770	2,260	1,600	1
2	3,200	2,560	6,400	5,540	4,520	3,200	2
3	4,800	3,840	9,600	8,320	6,780	4,800	3
4	6,400	5,120	12,800	11,090	9,040	6,400	4
5	8,000	6,400	16,000	13,860	11,300	8,000	5
6	9,600	7,680	19,200	16,640	13,560	9,600	6
Nylon Double Ply Web Slings (9,000 lb/in. material)							
1	3,200	2,560	6,400	5,540	4,520	3,200	1
2	6,400	5,120	12,800	11,090	9,040	6,400	2
3	8,880	7,100	17,760	15,390	12,540	8,880	3
4	11,520	9,210	23,040	19,660	16,270	11,520	4
5	14,000	11,200	28,000	24,260	19,775	14,000	5
6	16,320	13,050	32,640	28,280	23,050	16,320	6

(CFR 1910.184/ANSI/ASME B30.9)

- (1) For an endless sling with vertical hitch carrying a load of such size as to throw the legs more than 5 deg. off vertical use rated load data for eye and eye sling, basket hitch and corresponding leg angles.
- (2) Follow manufacturer's capacities, they vary from manufacturer to manufacturer.
- (3) Choker hitch values apply only to choke angles greater than 120 degrees.

**Table 11-16. Load capacity of Single Leg Polyester Roundslings in pounds
Endless and Eye to Eye Type Design Factor = 5:1**

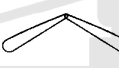
Size (Note 1)	 Vertical	 Choker	 Basket or two leg	 60 degrees	 45 degrees	 30 degrees	Size (Note 1)
1	2,600	2,100	5,200	4,500	3,700	2,600	1
2	5,300	4,200	10,600	9,300	7,500	5,300	2
3	6,400	6,700	16,800	14,500	11,900	6,400	3
4	10,600	8,500	21,200	18,400	15,000	10,600	4
5	13,200	10,600	26,400	22,900	18,700	13,200	5
6	16,800	13,400	33,600	29,100	23,800	16,800	6
7	21,200	17,000	42,400	36,700	30,000	21,200	7
8	25,000	20,000	50,000	43,300	35,400	25,000	8
9	31,000	24,800	62,000	53,700	43,800	31,000	9
10	40,000	32,000	80,000	69,300	56,600	40,000	10
11	53,000	42,400	106,000	91,800	74,900	53,000	11
12	66,000	52,800	132,000	114,300	93,300	66,000	12
13	90,000	72,000	180,000	155,900	127,300	90,000	13

(CFR 1910.184/ANSI/ASME B30.9)

NOTES:

1. Roundslings are identified by the vertical rated load shown on the tag. The Size Number in this column have been adopted by the Web Sling and Tiedown Association to describe certain polyester roundslings. They are included for reference only. Other polyester roundslings may have different vertical rated loads.
2. Color guidelines for polyester roundsling covers are widely used to indicate the vertical rated load of roundslings; however, this is not followed by some manufacturers. Always select and use roundslings by the rated load as shown on the tag, never by color.

15.2 DEFINITIONS

APPOINTED: Assigned specific responsibilities by the employer or the employer's representative.

AUTHORIZED: Assigned by a duly constituted administrative or regulatory authority to perform a specific function.

CRANE, MOBILE: For the purposes of this chapter, mobile cranes are defined as wheel-mounted cranes, truck cranes, and crawler cranes.

- o A **wheel-mounted** crane consists of a rotating structure with power plant, operating machinery, and boom, mounted on a base or platform equipped with axles and rubber-tired wheels for travel. The base is usually propelled by an engine in the superstructure, but it may be equipped with a separate engine controlled from the superstructure (see Figures 15-1, 15-3, 15-5, 15-6, 15-7, 15-9, and 15-10).
- o A **truck-mounted crane** consists of a rotating superstructure with power plant that operates machinery and boom, mounted on an automotive truck equipped with a power plant for travel. Commercial truck-mounted cranes are included in this category (see Figures 15-3, 15-7, 15-9, and 15-10).
- o A **crawler crane** consists of a rotating superstructure with power plant, operating machinery and boom, mounted on a base equipped with crawler treads for travel (see Figures 15-2 and 15-8).

DESIGNATED: Selected or assigned by the employer or the employer's representative as being qualified to perform specific duties.

DESIGNATED LEADER: “An individual assigned responsibility for hoisting and rigging activities requiring more than one person”.

FORKLIFT TRUCK: A high-lift self-loading truck equipped with load carriage and forks for transporting and tiering loads (see Figure 15-11).

LIFT, CRITICAL: A lift for which the application of requirements applicable to ordinary lifts would not adequately eliminate or control the likelihood or severity of the following:

- o personnel injury or significant adverse health impact (onsite or offsite).
- o significant release of radioactivity or other hazardous material or other undesirable conditions.
- o undetectable damage that would jeopardize future operations or the safety of a facility.
- o damage that would result in delay to schedule or other significant program impact such as loss of vital data.

LIFT, ORDINARY: Any lift not designated as a critical lift.

PERSON-IN-CHARGE (PIC): The manager or other responsible person (other than the equipment operator) known to be qualified and appointed to be responsible for the safe handling of critical loads.

Note: In the text, use of the imperative voice (as in “Ensure that the load is balanced”) or of the term “shall” refers to mandatory actions, whereas the term “should” refers to recommended actions.

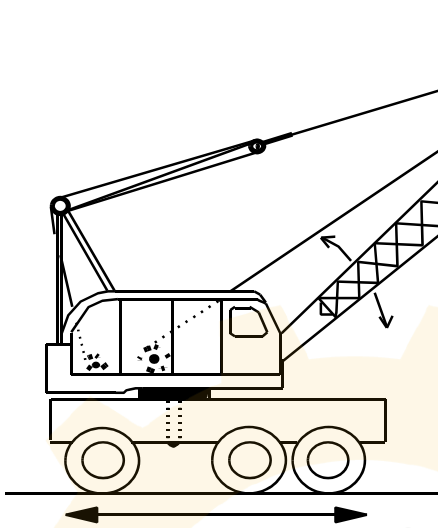

Figure 15-1. Wheel-mounted crane (single control station).

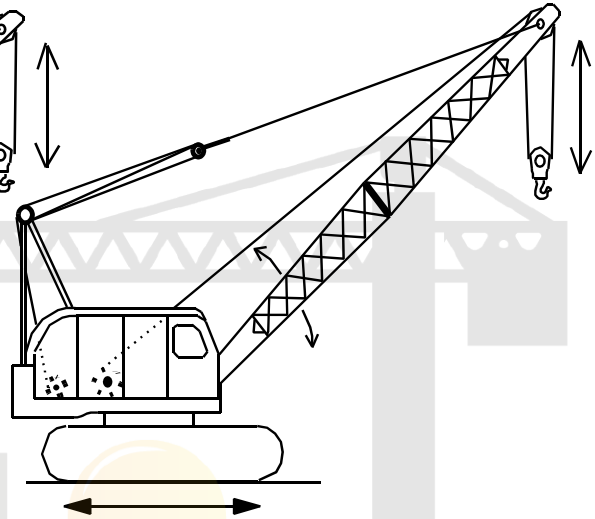

Figure 15-2. Crawler crane

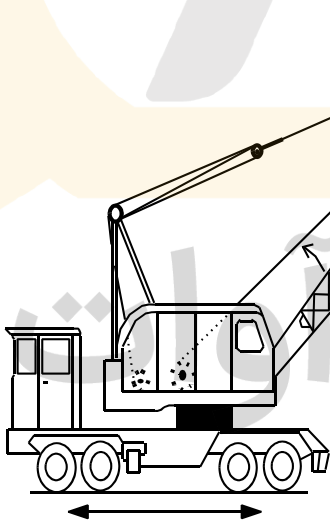

Figure 15-3. Wheel-mounted crane (Multiple control station).

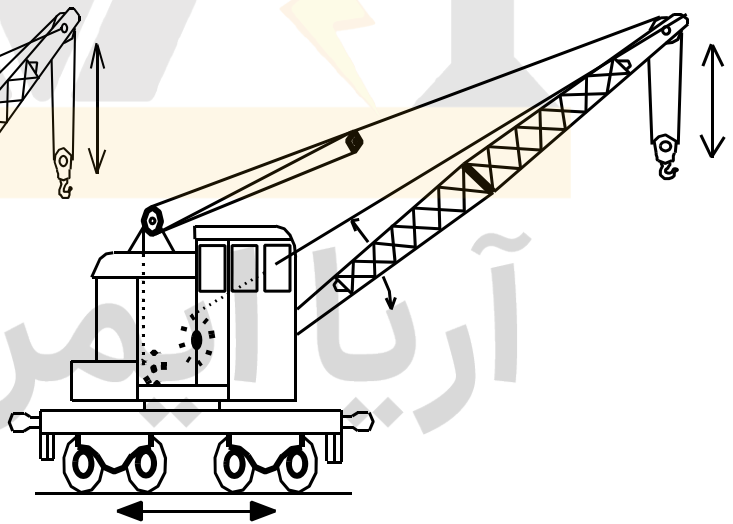

Figure 15-4. Locomotive crane.

General note for Figures 15-5 through 15-10:

The boom may have a base boom structure of sections (upper and lower) between or beyond which additional sections may be added to increase its length, or it may consist of a base boom from which one or more boom extensions are telescoped for additional length. These illustrations show some types.

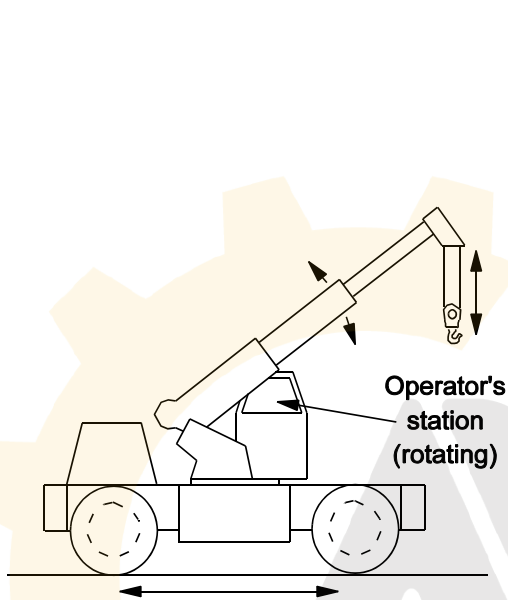

Figure 15-5. Wheel-mounted crane -- telescoping boom (Single control station).

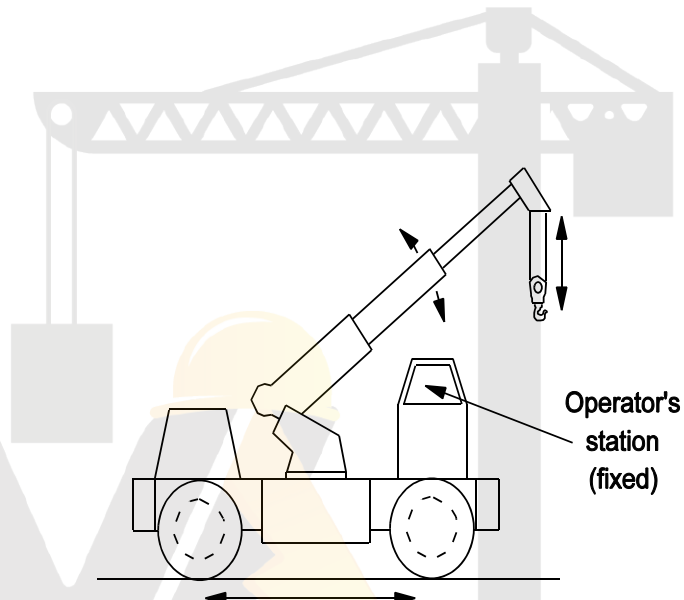

Figure 15-6. Wheel-mounted crane -- telescoping boom (Single control station).

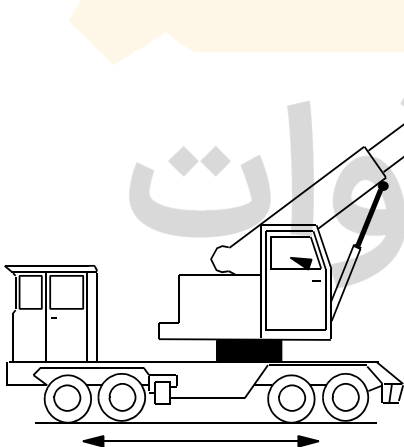

Figure 15-7. Wheel-mounted crane -- telescoping boom (Multiple control station).

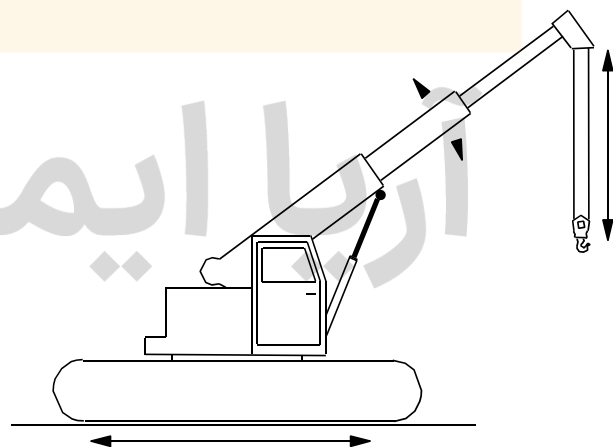

Figure 15-8. Crawler crane -- telescoping boom.

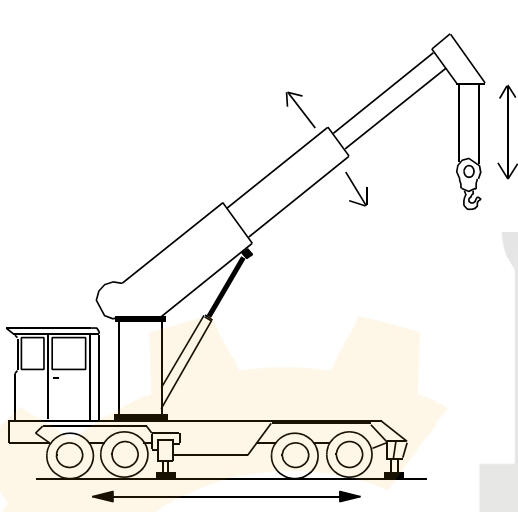

Figure 15-9. Commercial truck-mounted crane -- telescoping boom.

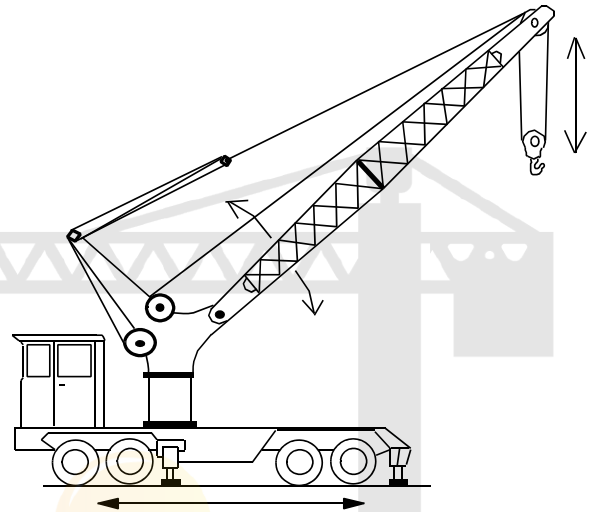

Figure 15-10. Commercial truck-mounted crane -- nontelesoping boom.

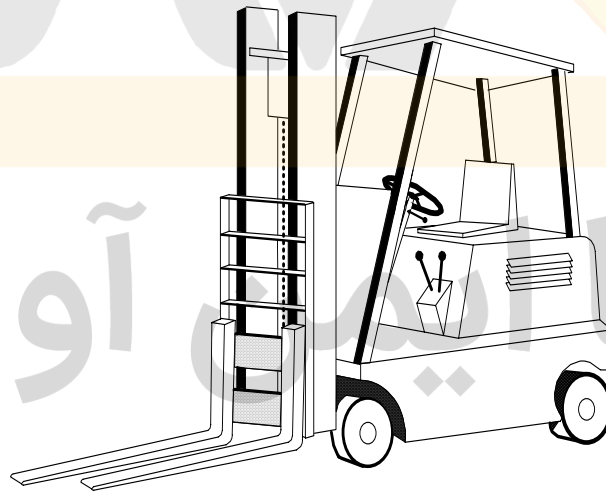

Figure 15-11. High-lift truck, counterbalanced truck, Cantilever truck, rider truck, forklift truck.

DOE-STD-1090-2001

QUALIFIED: A person, who, by possession of a recognized degree or certificate, or by professional standing, or who, by extensive knowledge, training, and experience, has successfully demonstrated an ability and competence to solve problems relating to the subject matter and work.

QUALIFIED ENGINEER/QUALIFIED ENGINEERING ORGANIZATION: An engineer or engineering organization whose competence in evaluation of the type of equipment in question has been demonstrated to the satisfaction of the responsible manager.

QUALIFIED INSPECTOR: One whose competence is recognized by the authority having jurisdiction and whose qualification to perform specific inspection activities has been determined, verified, and attested to in writing.

QUALIFIED OPERATOR: One whose competence to operate equipment safely and effectively (including the ability to accurately spot and control loads) can be demonstrated to and accepted by responsible management.

QUALIFIED RIGGER: One whose competence in this skill has been demonstrated by experience accepted as satisfactory by the responsible manager.

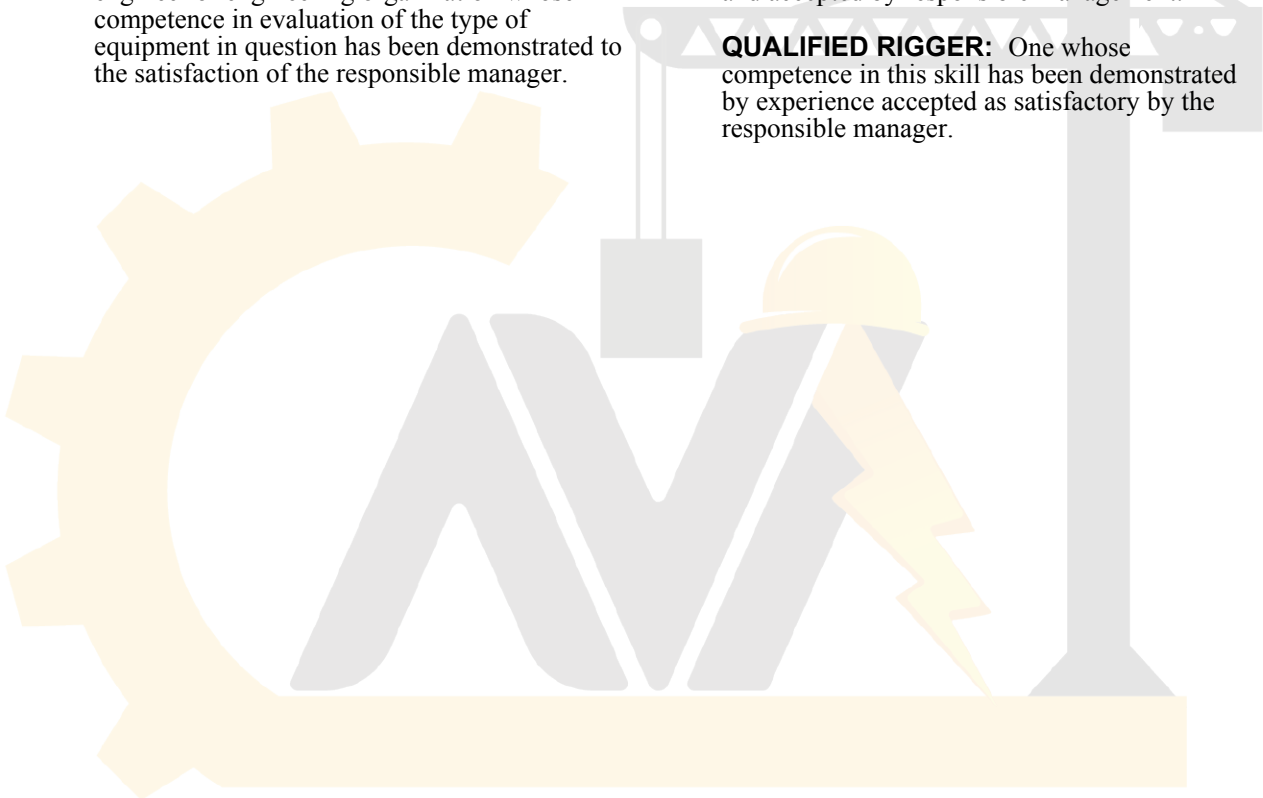

آریا ایمن آوات

15.6 LIFTING PERSONNEL

15.6.1 Mobile Cranes/Boom Trucks

This section specifies the operation, design, testing, and inspection requirements for the use of personnel lift platforms or baskets suspended from mobile cranes and/or boom trucks. This section implements the requirements of 29 CFR 1926.550(g) "Cranes and Derricks" and ASME B30.23, "Personnel Lifting Systems."

15.6.1.1 Personnel Lifting Evaluation

- a. The use of a crane to hoist employees on a personnel lift platform is prohibited, except when the erection, use, and dismantling of conventional means of reaching the worksite, such as a personnel hoist, ladder, stairway, aerial lift, elevating work platform or scaffold, would be more hazardous or is not possible because of structural design or worksite conditions.
- b. The manager specifically responsible for the overall work function to be performed shall determine that the erection, use, and dismantling of conventional means of reaching the work site (i.e., scaffold, ladder, stairway, aerial lift, or elevating work platform) would be more hazardous or is not possible because of structural design or worksite conditions.
- c. For each personnel lifting procedure, the manager responsible for the task shall authorize the use of a crane-suspended work platform and attest to the need for the operation through a written justification attesting to that need. A statement describing the operation and its time frame shall be included. The statement, after being approved by the authorizer, shall be retained at the job site.
- d. The manager specifically responsible for the overall work function shall not allow or require any operator to lift personnel under the following circumstances:
 1. The operator does not feel physically or mentally fit to perform the operation.
 2. The operator has been working for more than 10 hours prior to the start of the lift or the lift will not be completed before the operator has been working for 12 hours.

3. The operator did not have at least eight hours off, immediately prior to the work shift containing the person.

15.6.1.2 Designated Leader

- a. The Authorizing Manager shall appoint a Designated Leader for the entire personnel lifting operation.
- b. The Designated Leader shall ensure that a pre-job plan is prepared that defines the operation. The Designated Leader shall ensure:
 1. At each new job site prior to hoisting personnel, the personnel lift platform, rigging, and hook block shall be proof-tested by a qualified inspector to 125 percent of the personnel platform's rated capacity by holding it suspended for 5 minutes with the test load suitably distributed on the personnel platform.
 2. After proof-testing, any deficiencies revealed by inspection, or by the proof test, shall be corrected and another proof-test conducted.
 3. Any modification to the personnel lift platform or rigging shall require retesting.
 4. Test reports shall be kept on file and shall be readily available to appointed personnel.
 5. A meeting is held prior to the trial lift with the designated leader, qualified operator, signaler, persons to be lifted, and the person responsible for overall worksite safety to plan and review procedures to be followed. Procedures for entering and leaving the personnel platform and the points at which persons will enter and leave the device shall be reviewed. This meeting shall be held at each new work location, and shall be repeated for any employees newly assigned to the operation.
- c. The designated leader and the crane operator shall determine that:
 1. The crane shall be uniformly level within 1 percent of level grade and firm footing exist under both crawler tracks or under each outrigger float. Cribbing mats under tracks or blocks under outrigger floats are used as necessary to provide a firm and substantial footing.

2. Cranes equipped with outriggers shall have outriggers extended in accordance with the manufacturer's instructions.

3. Crane systems, controls, operator aids, and safety devices are activated and functioning properly.

4. No interferences exist.

5. The total weight of the loaded personnel lift platform (including personnel) and related rigging shall not exceed 50 percent of the crane rating under the planned conditions of use.

6. The personnel lift platform shall not be loaded in excess of its rated load capacity. The number of employees occupying the platform shall not exceed the number required for the work being performed.

15.6.1.3 Trial Lift

a. Each shift, before personnel initially enter the personnel lift platform, the operator and signaler shall conduct a trial lift. The trial lift shall include:

1. Loading the unoccupied personnel platform to at least the maximum anticipated load. Materials and tools to be used during the actual lift, if secured to prevent displacement, can be in the platform for the trial lift.

2. The trial lift shall be made from the location where personnel will enter the platform to each location where the platform will be hoisted and positioned. It is acceptable to perform a single trial lift on each shift for all locations to be reached from a single setup position.

3. The trial lift shall be repeated whenever:

- i. The crane (mobile) is moved and set up in a new location or returned to a previously used location.
- ii. When the lift route is changed, unless the operator determines that the safety of the hoisted personnel is not affected.
- iii. If a different crane operator is assigned.

15.6.1.4 Lifting Operations

15.6.1.4.1 Pre-Lift Meeting

a. A meeting attended by the operator, the ground crew, signaler(s), person(s) to be lifted, and the designated leader shall be held each shift to plan and review procedures to be followed, including:

1. Points at which persons will enter and leave the platform.

2. Procedures for entering and leaving the platform.

3. Special precautions if personnel will perform work from the suspended platform.

b. This meeting shall be held at each new work location, and shall be repeated for any employees newly assigned to the operation.

15.6.1.4.2 Pre-Lift Inspection

a. After the trial lift, prior to lifting personnel:

1. A visual inspection of the crane, rigging, and personnel lift platform shall be conducted by a qualified inspector. Any defects found that create a safety hazard shall be corrected prior to hoisting personnel.

2. The platform shall be lifted a few inches and inspected to ensure that it is secure and properly balanced.

15.6.1.4.3 Lifting Personnel

a. Prior to hoisting personnel in a personnel lift platform ensure that:

1. No hazardous conditions exist with the platform and its associated rigging.

2. The hoist line is not wrapped around any part of the platform.

3. Hoist ropes are free of kinks.

4. Multiple-part lines are not twisted around each other.

5. The primary attachment is centered over the platform.

6. Ropes are properly seated on drums and sheaves.

7. The crane is within 1 percent of level.

DOE-STD-1090-2001

8. The crane has an anti two-block device installed and operational.

b. Employees being hoisted or working in a personnel lift platform shall:

1. Remain in continuous sight of, and in direct communication with, the operator or signaler. In situations where direct visual contact with the operator is not possible and the use of a signaler would create a hazard for that person, direct communication alone (such as a two-way radio) may be used.

2. Keep all parts of their bodies inside the suspended personnel lift platform during raising, lowering, and positioning to avoid pinch points.

3. Wear body harnesses with lanyards attached to the lower load block or overhaul ball, or to a structural member within the platform that is capable of supporting a fall impact.

4. Not stand on or work from the top rail, midrail, or toe board of the suspended personnel platform.

5. When working above water, the requirements of 29 CFR 1926.106 (Occupational Safety and Health Regulations for Construction) shall also apply.

6. When welding is being performed from the personnel lift platform, the electrode holders shall be protected from contact with metal components of the personnel platform.

c. Operators of cranes hoisting personnel in a personnel lift platform shall:

1. Before commencing or continuing the lift, consult with the designated leader when ever there is any doubt as to the safety of the lift.

2. Remain at the controls when the personnel lift platform is occupied.

3. Operate the crane so that lowering will be power-controlled (no free-fall).

4. Ensure movement of the personnel lift platform is performed in a slow, controlled, cautious manner with no sudden movements of the crane or the platform. The lifting or

lowering speed shall not exceed 100 ft/min (30 m/min).

5. After the personnel lift platform is positioned, set all brakes and locks on the lift crane before personnel perform any work.

6. If the personnel lift platform cannot be landed, ensure it is tied to the structure before personnel get off or on.

7. Ensure that no lifts are made on another of the crane's load lines while personnel are suspended on the personnel lift platform.

d. Suspended personnel lift platforms shall be used only for personnel, their tools, and sufficient materials to do their work. They shall not be used for transporting bulk materials.

e. Personnel lift platforms should not be used in winds greater than 20 mph (32.2 km/hr), electric storms, snow, ice, sleet, or other adverse weather conditions that could affect the safety of personnel.

f. Use tag lines to control motion of occupied personnel lift platforms unless their use creates an unsafe condition.

g. Cranes shall not travel while personnel are in the platform. Exceptions to this provision shall be approved by the manager specifically responsible for the overall work function and precautions to be taken documented in the personnel lift plan.

15.6.1.5 Mobile Cranes/Boom Trucks

Mobile cranes are designed and intended for handling materials, not personnel. In addition to the general requirements in Section 15.5.3.1, "Operating the Unit," the following requirements shall be met when lifting personnel with a mobile crane:

a. Personnel are permitted to ride only in one of the following:

1. A personnel lift platform that is supported from the crane's hook which meets the requirements of Section 15.6.1.6, "Personnel Platform."

2. A personnel basket attached directly to the boom which is approved by the crane manufacturer.

b. Cranes and derricks with variable-angle booms shall be equipped with a boom-angle indicator that is readily visible to the operator.

c. Cranes with telescoping booms shall be equipped with a device to indicate clearly to the operator, at all times, the boom's extended length, or an accurate determination of the load radius to be used during the lift shall be made prior to hoisting personnel.

d. A positive-acting device shall be used that prevents contact between the load block or overhaul ball and the boom tip (anti-two-blocking device), or a system shall be used that deactivates the hoisting action before damage occurs in the event of a two-blocking situation (two-block damage-prevention feature).

e. Cranes having booms in which lowering is controlled by a brake without aid from other devices which slow the lowering speeds is prohibited.

f. Crane load lines shall be capable of supporting, without failure, at least seven times the maximum intended load, except where rotation resistant rope is used, the lines shall be capable of supporting without failure, at least ten times the maximum intended load.

g. Hydraulic cranes shall have check valves or other devices that will prevent uncontrolled movement in the event of system failure, engine failure, or hose rupture.

h. Cranes shall have a means to prevent retraction of hydraulically or pneumatically activated outriggers or stabilizers in the event a hydraulic or pneumatic line fails.

i. Pendant supported, jib type, boom extensions without positive stops are prohibited for personnel lifting.

j. Hooks on overhaul ball assemblies, lower load blocks, or other attachment assemblies shall be of the type that can be closed and locked, eliminating the hook throat opening. (Figure 15-18). Alternatively, an alloy anchor type shackle with a bolt, nut and retaining pin may be used.

15.6.1.6 Personnel Lift Platform

15.6.1.6.1 Platform Design and Construction

There is no attempt to comprehensively address platform design and construction in this section. Nevertheless, because many platform design and construction features can be observed and should be known by the platform user, (See Figures 15-19) the following key design and construction requirements are presented:

a. The personnel lift platform and suspension system shall be designed by a qualified person competent in structural design and familiar with national consensus standards governing personnel platform design.

b. All welding of the platform shall be performed by a qualified welder in accordance with ANSI/AWS D1.1. Where special steels or other materials are used, the manufacturer shall provide welding procedures. Welds shall be inspected by a qualified inspector.

c. The personnel lift platform shall have:

1. A minimum design factor of five.
2. A plate specifying its empty weight and its rated load capacity or maximum intended load.
3. Perimeter protection consisting of a top rail approximately 45 in. (115 cm) high, a toe board at least 4 in. (10 cm) high, and a midrail approximately halfway between the top rail and the toe board.
4. A grab rail inside the personnel lift platform to minimize hand exposure.
5. Anchorage points within the platform for attaching personnel fall protection lanyards.
6. The sides of the platform enclosed from the toe board to the midrail with solid

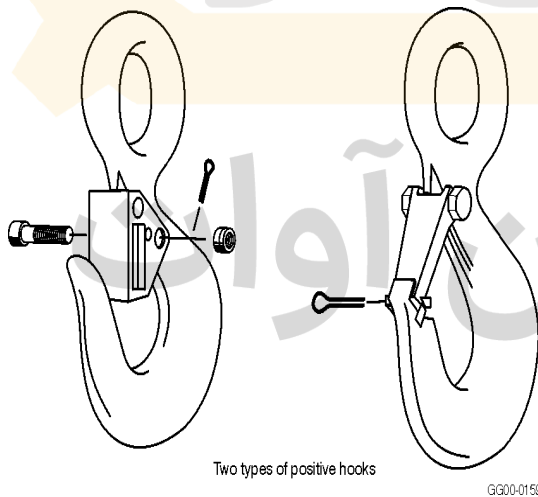

Figure. 15-18. Positive Hooks

construction or expanded metal having openings no greater than ½ in. (1.27 cm).

7. Platform access gates, including sliding or folding types, if installed, shall have a positive acting device to restrain the gate from accidental opening. Swinging type access gates shall open only to the interior of the personnel lift platform.

8. Rough edges exposed to contact by employees surfaced (ground smooth) to prevent injury.

9. High-visibility color or marking for easy identification.

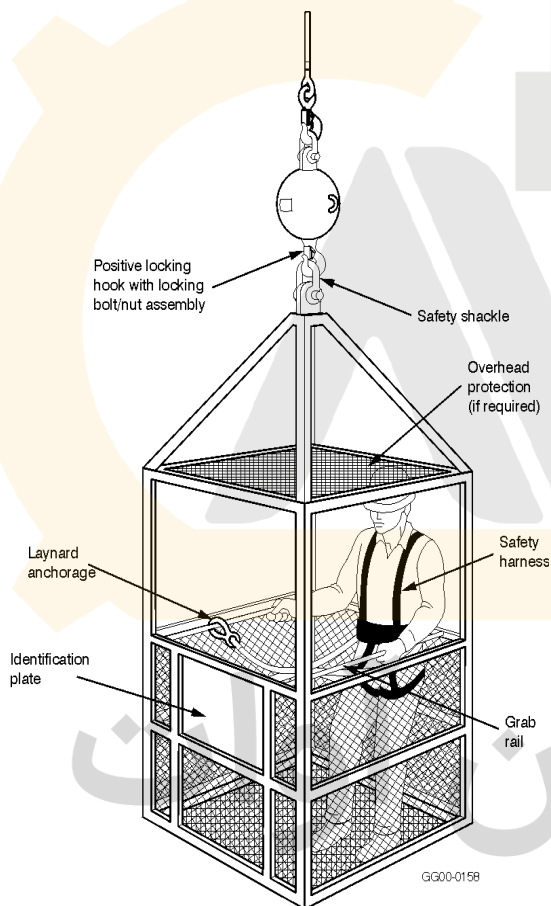

Figure 15-19. Personnel Lift Platform

d. In addition to wearing hard hats, personnel shall be protected by overhead protection on the personnel lift platform when there is an overhead hazard. Sufficient headroom shall be provided to allow employees to stand upright in the platform.

15.6.1.6.2 Platform Suspension System

a. Wire rope, shackles, rings, master links, and other rigging hardware must be capable of supporting, without failure, at least five times the maximum intended load applied or transmitted to that component and guided by the following:

1. One-leg system - design factor of seven.

2. Two or three-leg system - design factor of five for each leg.

3. Four-leg system - design factor of five with only three legs under stress.

4. Where rotation resistant rope is used, the slings shall be capable of supporting without failure at least ten times the maximum intended load.

b. Sling suspension systems shall utilize a master link or safety type shackle to connect the personnel lift platform to the load line to ensure that the load is evenly divided among the suspension system legs.

c. The suspension system shall be designed to minimize tipping of the platform due to movement of employees occupying the platform.

d. The sling suspension system attaching the personnel lift platform to the hoist line shall not be used for any other purpose when not hoisting personnel.

e. Shackles used in any part of the suspension system shall be a safety type (bolt-type shackle with nut and cotter pin).

f. All eyes in wire rope slings shall be fabricated with thimbles.

g. Wire rope clips, wedge sockets, or knots shall not be used in suspension system sling assemblies.

h. Synthetic webbing, natural or synthetic fiber rope shall not be used for the suspension systems.

i. Chain sling suspension systems shall use a minimum of grade 80 chain.

The following industry guides are available from the N.C. Department of Labor's Occupational Safety and Health Division:

- #1. *A Guide to Safety in Confined Spaces*
- #2. *A Guide to Procedures of the N.C. Safety and Health Review Commission* (downloadable PDF **ONLY**)
- #3. *A Guide to Machine Safeguarding*
- #4. *A Guide to OSHA in North Carolina*
- #5. *A Guide for Persons Employed in Cotton Dust Environments* (downloadable PDF **ONLY**)
- #6. *A Guide to Lead Exposure in the Construction Industry* (downloadable PDF **ONLY**)
- #7. *A Guide to Bloodborne Pathogens in the Workplace*
- #8. *A Guide to Voluntary Training and Training Requirements in OSHA Standards*
- #9. *A Guide to Ergonomics*
- #10. *A Guide to Farm Safety and Health* (downloadable PDF **ONLY**)
- #11. *A Guide to Radio Frequency Hazards With Electric Detonators* (downloadable PDF **ONLY**)
- #12. *A Guide to Forklift Operator Training*
- #13. *A Guide to the Safe Storage of Explosive Materials* (downloadable PDF **ONLY**)
- #14. *A Guide to the OSHA Excavations Standard*
- #15. *A Guide to Developing and Maintaining an Effective Hearing Conservation Program*
- #16. *A Guide to Construction Jobsite Safety and Health/Guía de Seguridad y Salud para el Trabajo de Construcción*
- #17. *A Guide to Asbestos for Industry*
- #18. *A Guide to Electrical Safety*
- #19. *A Guide to Occupational Exposure to Wood, Wood Dust and Combustible Dust Hazards* (downloadable PDF **ONLY**)
- #20. *A Guide to Cranes and Derricks*
- #23. *A Guide to Working With Electricity*
- #25. *A Guide to Personal Protective Equipment*
- #26. *A Guide to Manual Materials Handling and Back Safety*
- #27. *A Guide to the Control of Hazardous Energy (Lockout/Tagout)*
- #28. *A Guide to Eye Wash and Safety Shower Facilities*
- #29. *A Guide to Safety and Health in Feed and Grain Mills* (downloadable PDF **ONLY**)
- #30. *A Guide to Working With Corrosive Substances* (downloadable PDF **ONLY**)
- #31. *A Guide to Formaldehyde* (downloadable PDF **ONLY**)
- #32. *A Guide to Fall Prevention in Industry*
- #32s. *Guía de Prevención de las Caídas en la Industria (Spanish version of #32)*
- #33. *A Guide to Office Safety and Health* (downloadable PDF **ONLY**)
- #34. *A Guide to Safety and Health in the Poultry Industry* (downloadable PDF **ONLY**)
- #35. *A Guide to Preventing Heat Stress*
- #38. *A Guide to Safe Scaffolding*
- #40. *A Guide to Emergency Action Planning*
- #41. *A Guide to OSHA for Small Businesses in North Carolina*
- #41s. *Guía OSHA para Pequeños Negocios en Carolina del Norte (Spanish version of #41)*
- #42. *A Guide to Transportation Safety*
- #43. *A Guide to Combustible Dusts*
- #44. *A Guide to Respiratory Protection*

Occupational Safety and Health (OSH) Sources of Information

You may call 1-800-NC-LABOR (1-800-625-2267) to reach any division of the N.C. Department of Labor; or visit the NCDOL home page on the World Wide Web: <http://www.nclabor.com>.

N.C. Occupational Safety and Health Division

Mailing Address:
1101 Mail Service Center
Raleigh, NC 27699-1101
Local Telephone: (919) 807-2900 Fax: (919) 807-2856

Physical Location:
111 Hillsborough St.
(Old Revenue Building, 3rd Floor)

For information concerning education, training and interpretations of occupational safety and health standards contact:

Education, Training and Technical Assistance Bureau

Mailing Address:
1101 Mail Service Center
Raleigh, NC 27699-1101
Telephone: (919) 807-2875 Fax: (919) 807-2876

Physical Location:
111 Hillsborough St.
(Old Revenue Building, 4th Floor)

For information concerning occupational safety and health consultative services and safety awards programs contact:

Consultative Services Bureau

Mailing Address:
1101 Mail Service Center
Raleigh, NC 27699-1101
Telephone: (919) 807-2899 Fax: (919) 807-2902

Physical Location:
111 Hillsborough St.
(Old Revenue Building, 3rd Floor)

For information concerning migrant housing inspections and other related activities contact:

Agricultural Safety and Health Bureau

Mailing Address:
1101 Mail Service Center
Raleigh, NC 27699-1101
Telephone: (919) 807-2923 Fax: (919) 807-2924

Physical Location:
111 Hillsborough St.
(Old Revenue Building, 2nd Floor)

For information concerning occupational safety and health compliance contact:

Safety and Health Compliance District Offices

Raleigh District Office (3801 Lake Boone Trail, Suite 300, Raleigh, NC 27607)

Telephone: (919) 779-8570 Fax: (919) 420-7966

Asheville District Office (204 Charlotte Highway, Suite B, Asheville, NC 28803-8681)

Telephone: (828) 299-8232 Fax: (828) 299-8266

Charlotte District Office (901 Blairhill Road, Suite 200, Charlotte, NC 28217-1578)

Telephone: (704) 665-4341 Fax: (704) 665-4342

Winston-Salem District Office (4964 University Parkway, Suite 202, Winston-Salem, NC 27106-2800)

Telephone: (336) 776-4420 Fax: (336) 776-4422

Wilmington District Office (1200 N. 23rd St., Suite 205, Wilmington, NC 28405-1824)

Telephone: (910) 251-2678 Fax: (910) 251-2654

*****To make an OSHA Complaint, OSH Complaint Desk: (919) 807-2796*****

For statistical information concerning program activities contact:

Planning, Statistics and Information Management Bureau

Mailing Address:
1101 Mail Service Center
Raleigh, NC 27699-1101
Telephone: (919) 807-2950 Fax: (919) 807-2951

Physical Location:
111 Hillsborough St.
(Old Revenue Building, 2nd Floor)

For information about books, periodicals, vertical files, videos, films, audio/slide sets and computer databases contact:

N.C. Department of Labor Library

Mailing Address:
1101 Mail Service Center
Raleigh, NC 27699-1101
Telephone: (919) 807-2848 Fax: (919) 807-2849

Physical Location:
111 Hillsborough St.
(Old Revenue Building, 5th Floor)

N.C. Department of Labor (Other than OSH)

1101 Mail Service Center
Raleigh, NC 27699-1101
Telephone: (919) 733-7166 Fax: (919) 733-6197